

**ZEAFIVE<sup>®</sup>**



PRODUCT  
INSTRUCTION  
VIDEO

# INSTALLATION GUIDE

Freestanding Bathtub

**MODEL No.Z31E1S**

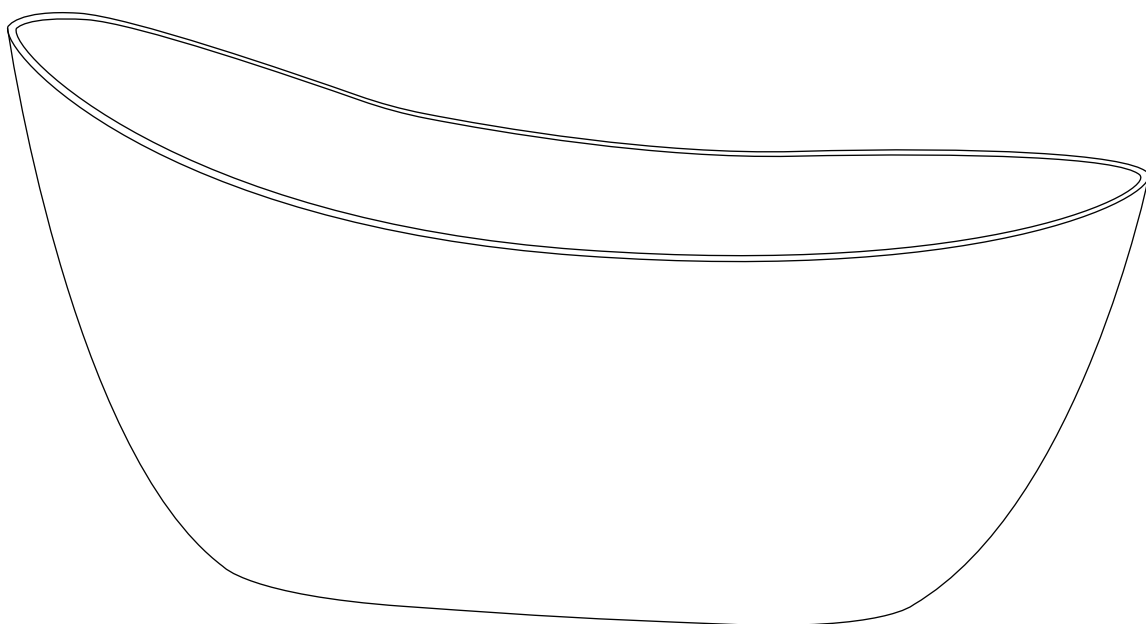

# THANK YOU!

*Dear Valued Customer,*

*Thanks to your kind support of ZEAFFIVE, we hope our product can improve the quality of your life.*

*As our valued customer, your comments and opinions are very important to us. If you have any concerns, questions, or comments, we hope that you will bring them to our attention.*

*Please keep the carton and packaging materials until your product is completely installed.*

*Feel free to contact us if you encounter any problems such as missing parts, or product defects during the installation process. We are happy to provide you with the most sincere service.*

*Sincerely,  
Service Team*



Please read all instructions carefully before proceeding with installation.



Due to the complexity of the installation procedure, a professional plumber is required.

---

## **TABLE OF CONTENTS**

<b>1. Pre-installation Checklist</b>	<b>P3</b>
<b>2. Tools Required</b>	<b>P6</b>
<b>3. Installation Instructions</b>	<b>P7</b>
<b>4. Care &amp; Maintace</b>	<b>P14</b>
<b>5. Warranty</b>	<b>P16</b>

# PRE-INSTALLATION CHECKLIST

Before installing ZEAFFIVE freestanding bathtub, it's important to perform a pre-check to ensure a smooth and successful installation. Here are some key factors to consider during the pre-installation check:

## 1. Inspect the bathtub

- Careful remove the tub from it's box/crate. 2 people are required to lift from the box. Do not carry the bathtub by its panel.
- To avoid scratches or damages, be sure to set it on the soft blanket on the top of the cardboard.
- Inspect the bathtub for any damages, if any damages are found please get in touch with us, the contact information is listed on the bottom of each page.



## 2. Leak test of the bathtub

- Set the bathtub on two 4"X4" lumber pieces, in order to have access from the bottom of the bathtub.
- Put a tray beneath the bathtub. Check for any leaks around the drain and pipe. If a leakage occurs please disassemble the drain line, you can apply a plumbing silicone caulk to fix the leakage.

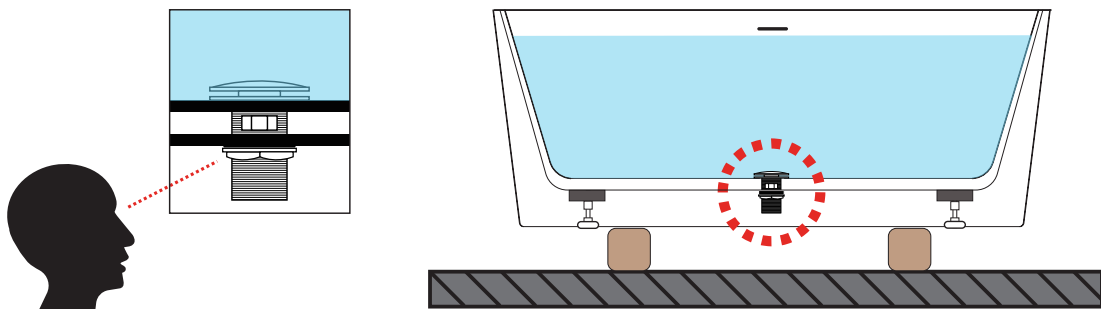
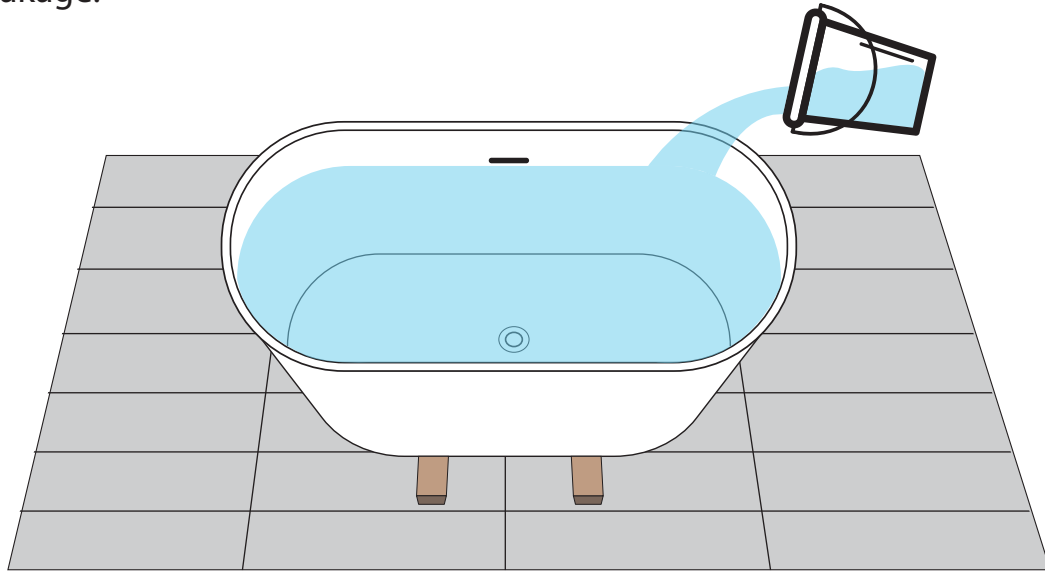

## 3. Measurement and Fit

- Measure the space where the freestanding bathtub will be installed to ensure it fits properly.
- Check the dimensions of the bathtub and compare them with the available space, including doorways and hallways for delivery and installation.

## 4. Floor Strength

- Ensure that the floor can support the weight of the bathtub when filled with water and occupants. Consider reinforcing the floor if necessary.

## 5. Plumbing Connections

- Check the existing plumbing connections to ensure they are compatible with the bathtub's drain and overflow assembly.
- Confirm the location of the drain and overflow openings on the bathtub align with the existing plumbing.

## 6. Accessibility

- Ensure there is enough space around the bathtub for installation and maintenance access.
- Check if there are any obstacles or obstructions that may hinder the installation process.

## 7. Leveling

- Verify that the installation area is level to prevent the bathtub from rocking or shifting.
- Use a level to check the floor and make adjustments if needed before installing the bathtub.

## 8. Drainage

- Check the drainage system to ensure it is clear and functioning properly. Clear any clogs or debris that may affect drainage before installing the bathtub.

## 9. Utilities

- Ensure that water supply lines and drainage pipes are accessible and properly connected for the bathtub installation.
- Consider the location of electrical outlets if the bathtub has built-in features that require power.

## 10. Installation Requirements

- Gather all necessary tools and materials needed for the installation process.

**By conducting a thorough pre-installation check and addressing any potential issues or concerns, you can ensure a successful and trouble-free installation of your freestanding bathtub. If you encounter any challenges or uncertainties during the pre-check, consider consulting a professional plumber or contact our customer service team for assistance. Our contact information is listed at the bottom of each page.**

# INSTALLATION INSTRUCTIONS

Installing a freestanding bathtub is a rewarding project that can enhance the aesthetic and functionality of your bathroom. Here is a general guide on how to install a freestanding bathtub:

## TOOLS REQUIRED



Level



Soft Cloth or blanket



Tape Measure

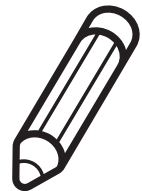

Pencil



Construction Adhesive



Hammer

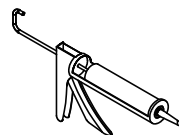

Silicone caulk



Shims / Lumber



Knife

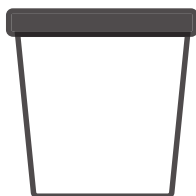

Plumbers putty

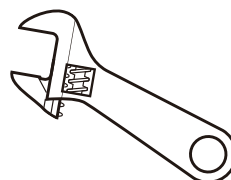

Adjustable wrench



Furring strips

# INSTALLATION STEPS

## STEP 1

### Prepare the Installation Area

Ensure the floor is level and can support the weight of the bathtub and water. Measure the space to ensure the bathtub fits properly.

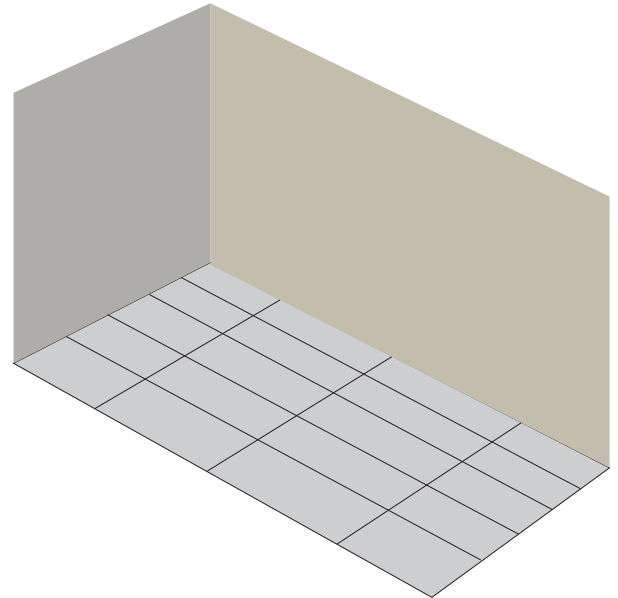

## STEP 2

### Position the Bathtub

Carefully position the freestanding bathtub in the desired location, ensuring it is level. Use shims if needed to stabilize the bathtub and ensure it is even.

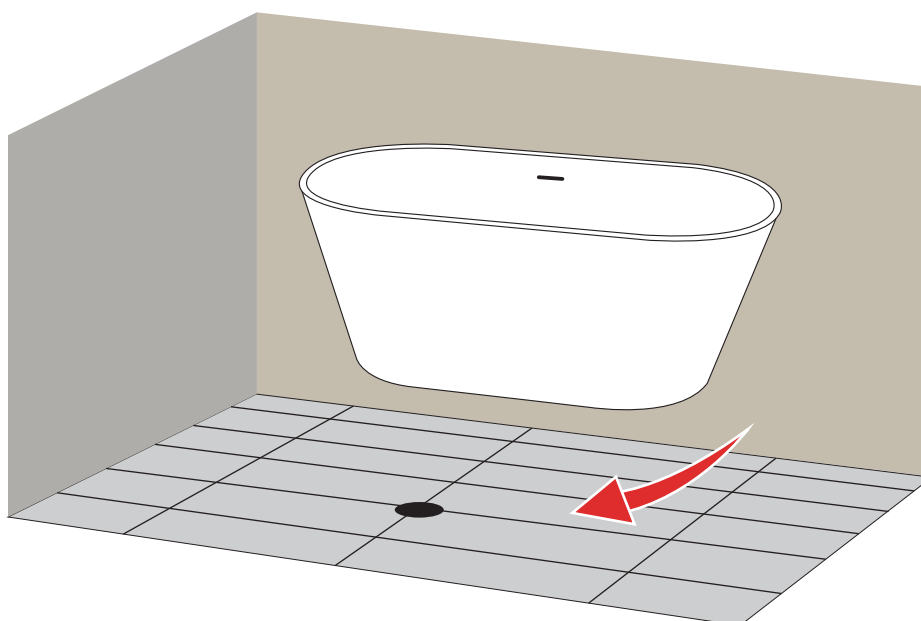

## STEP 3

### Mark locations

- Use a pencil to mark the outline of the bathtub's exact installed location and the drain hole on the floor.
- Move the bathtub away so that the plumbing can be installed.

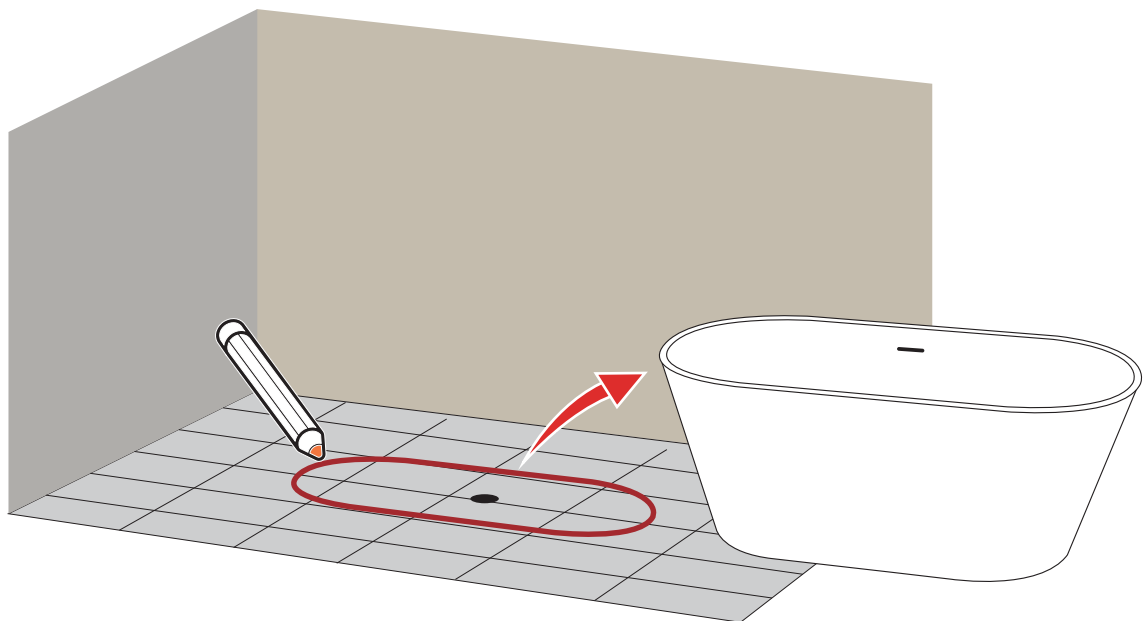

## STEP 4

### Adjust the bathtub feet level

-Turn the tub upside down and set it on the soft blanket, to prevent any scratching of the bathtub trim.

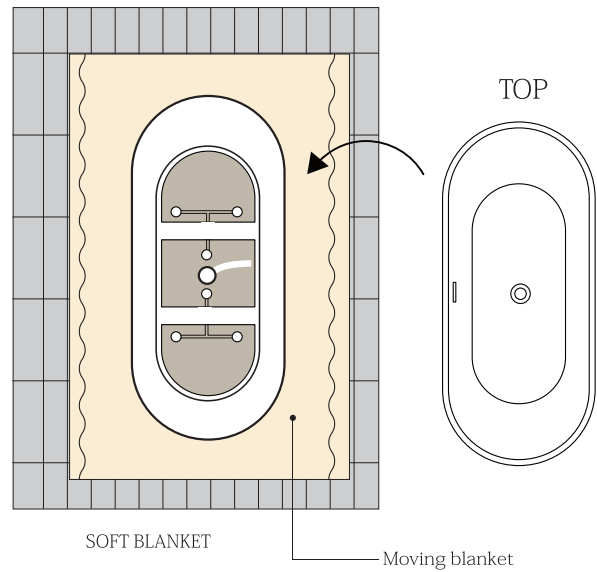

- Place a level across the bottom of the tub and adjust the tub feet leveler to touch the level. Then raise the leveler an additional 1/8" or 3/16" so that the weight of the tub, water, and user are fully supported by the feet adjuster and not the tub walls.

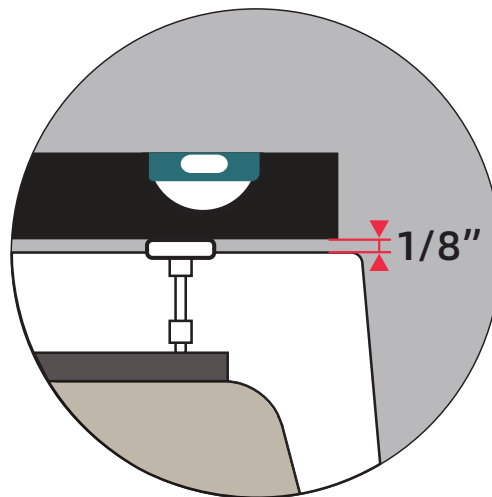
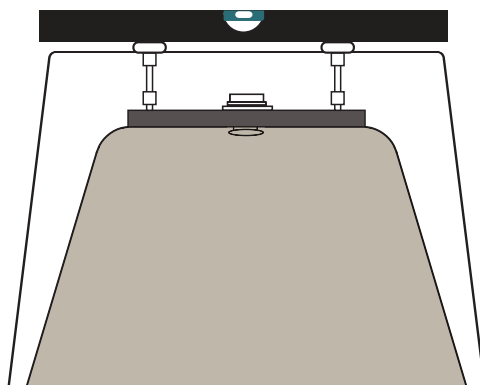
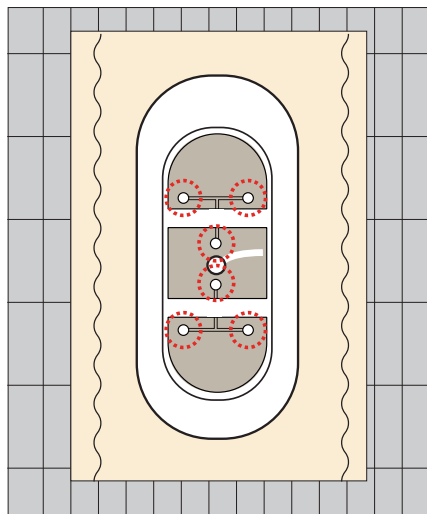

## STEP 5

### Measure & cut

Measure and cut the tail piece to the appropriate length to reach the trap adapter. When setting the tub drain, insert tail piece with 1-1/2" slip joint and rubber washer into the trap adapter and tighten properly.



## STEP 6

### Connect the Drain

- Flip the tub over and carefully set the tub into position with the tailpiece assembly to the waste vent and connect to the drain.

-Connect the drain pipe to the bathtub drain using the provided parts. Ensure the connections are tight and secure. Use a P-trap and tubing cutter to connect the drain to the existing plumbing.

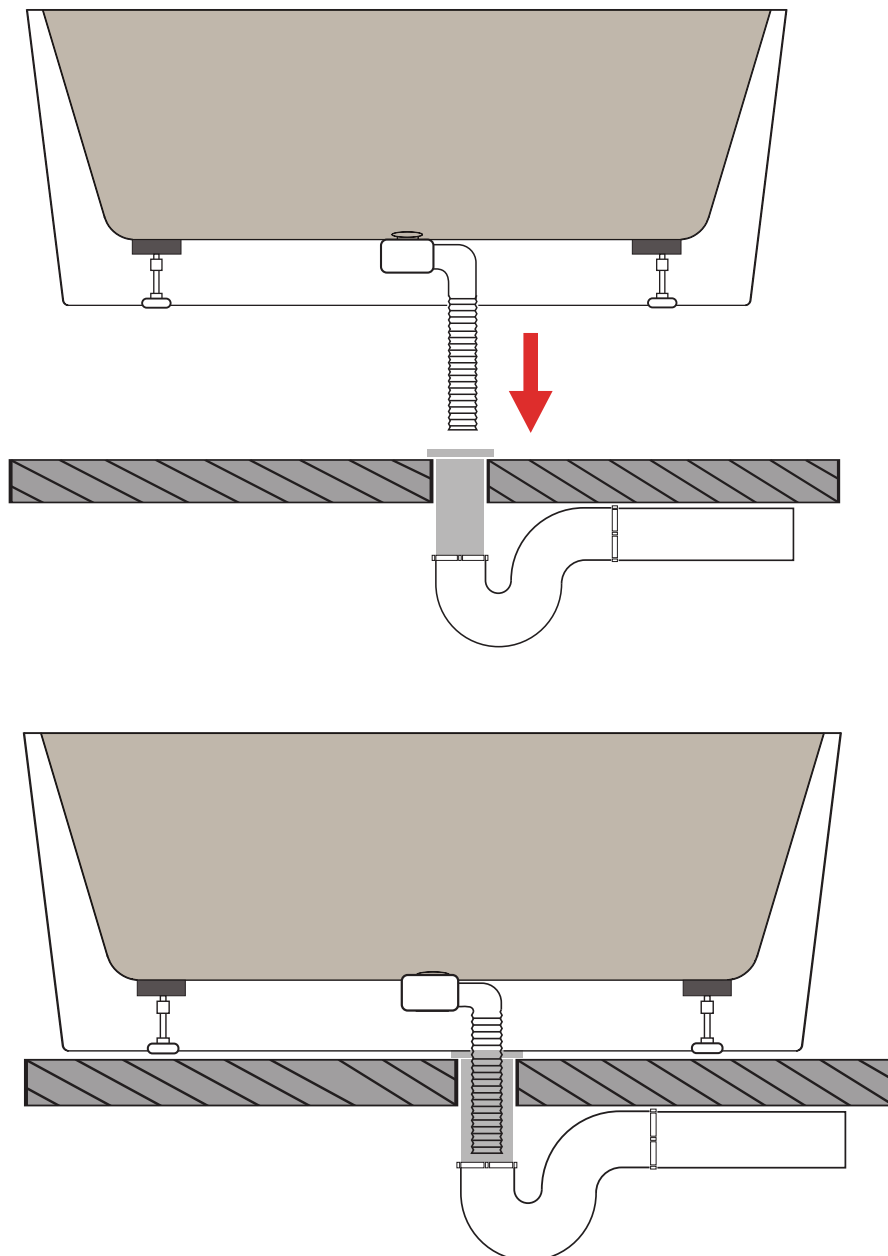

## STEP 7

### Secure the Bathtub

Secure the bathtub to the floor if necessary. Some freestanding bathtubs have leveling feet or brackets that need to be anchored to the floor for stability.

## STEP 8

### Caulk the Seams

Apply silicone caulk along the edges of the bathtub where it meets the floor and walls to create a watertight seal. This will prevent water from seeping underneath the bathtub.



24 hours

## STEP 9

### Test the Tub

Fill the bathtub with water to check for any leaks or issues. Ensure the drain is working properly and that the bathtub is securely installed.



## STEP 10

### Finish and Clean Up

Trim any excess caulk and clean up any debris from the installation process. Wipe down the bathtub to remove any dirt or marks.

**By following these steps and the manufacturer's specific instructions, you can successfully install a freestanding bathtub in your bathroom. If you are unsure about any part of the installation process, consider consulting a professional plumber for assistance.**

# CARE & MAINTACE

Caring for and maintaining your alcove bathtub is essential to keep it looking great and functioning well for years to come. Here are some tips and guidelines for proper care and maintenance:

**1.Rinse After Use:** After each use, rinse the tub with warm water to remove soap scum, hair, and other residues. This helps prevent buildup and staining.

**2.Wipe Down:** Use a soft cloth or sponge to wipe down the surfaces of the tub after rinsing to eliminate any remaining moisture. This can help prevent mold and mildew.

## Weekly Maintenance

**3.Regular Cleaning:** Use a non-abrasive cleaner formulated for your specific bathtub material (e.g., acrylic, fiberglass, porcelain). Avoid harsh chemical cleaners that can damage the surface.

**4.Scrub Gently:** With a soft-bristle brush or sponge, scrub the tub gently to remove soap scum and mineral deposits. Pay special attention to areas around the drain and faucet.

**5.Check for Mold and Mildew:** Inspect corners and crevices for signs of mildew or mold. If you notice any, use a mold cleaner or a mixture of water and vinegar to treat the area.

## Monthly Maintenance

**6.Inspect Seals and Caulking:** Check the caulking around the tub, especially where it meets the walls and the floor. Look for cracks or gaps that might allow water to seep behind the tub. If you find any issues, reapply silicone caulk to create a watertight seal.

**7.Drain Maintenance:** Occasionally, check and clean the drain, removing any hair or debris that may have accumulated. You can also use a mixture of baking soda and vinegar to keep the drain clear. Pour it down the drain, wait a few minutes, then flush with hot water.

## Seasonal Care

**8.Deep Cleaning:** Every few months, consider doing a deeper cleaning of the tub. You can use a mild bleach solution (following the manufacturer's guidelines) or a specialized bathtub cleaner.

**9. Check for Wear and Tear:** Periodically inspect your bathtub for any signs of chips, scratches, or fading. If you notice any damage, address it promptly to prevent further deterioration.

### Additional Tips

- **Avoid Harsh Chemicals:** Do not use abrasive cleaners, scouring pads, or harsh chemicals, as they can scratch or dull the surface of the bathtub.
- **Be Mindful of Bath Products:** Some bath oils and bubble baths can cause film buildup on the tub. Use products that are gentle and designed for use in bathtubs.
- **Temperature Changes:** Avoid drastic temperature changes, like pouring boiling water directly into a cold tub, as this can cause damage.

### 10. Avoid Scratches and Damage:

- Use a soft cloth or sponge when cleaning the bathtub to prevent scratches on the acrylic surface.
- Avoid using abrasive scrubbing pads, brushes, or harsh cleaning tools that can scratch or damage the acrylic material.
- Do not place sharp or heavy objects directly on the bathtub surface, as they can cause scratches or dents.

### 11. Preventing Stains:

- To prevent stains, avoid leaving soap, shampoo, or other bath products sitting on the bathtub surface for extended periods. Wipe up spills promptly.
- Use a bath mat or rug inside the tub to prevent scratches and to absorb excess water, which can cause water spots and stains.

### 12. Temperature and Chemicals:

- Do not use hot water above 120°F (49°C) when cleaning the bathtub, as excessive heat can damage the acrylic material.
- Avoid using harsh chemicals, bleach, ammonia, or abrasive cleaners on the acrylic surface, as they can cause discoloration and damage.

### 13. Maintenance:

- Inspect the bathtub regularly for any signs of damage, cracks, or leaks. Address any issues promptly to prevent further damage.
- Keep the bathtub well-ventilated to prevent mold and mildew growth. Wipe down the surface and walls of the bathtub after each use to remove excess moisture.

By following these care and maintenance tips, you can keep your alcove acrylic bathtub looking clean, pristine, and in good condition for years to come. Proper care and regular maintenance will help extend the life of your bathtub and ensure a relaxing and enjoyable bathing experience.

# LIMITED WARRANTY COVERAGE

## 1 YEARS LIMITED WARRANTY

ZEAFIVE products are made with quality materials and excellent craftsmanship to provide the customers a long-lasting product. In the case of any defects in materials or craftsmanship under regular use were inspected in the first one year of delivery, ZEAFIVE will provide replacement parts at no charge, or at its option, replace any product or part of the product that is deemed defective, under normal installation, use, service and maintenance. This warranty applies only to the original purchaser. Proof of purchase will be required in the case of a claim.

## ZEAFIVE will, as its option

- (1) Repair or replace the defective part(s) or product(s) at no charge;
- (2) Issue a refund of the original purchase price of the product(s) (Valid within 30 days from the date of delivery);
- (3) Issue a credit to be applied toward the purchase of a new ZEAFIVE product shipping/delivery charges may apply and are in ZEAFIVE's sole discretion.

ZEAFIVE recommends the installations to be made by a licensed, professional plumber. ZEAFIVE will not be held responsible for any damage or product failure due to improper installation, misuse, or failure to use a licensed professional. ZEAFIVE is not responsible for any removal or installation cost.

This limited warranty shall not apply to goods that have been subject to accident, negligence, improper installation, product abuse, product misuse, or use of cleaners containing abrasives, alcohol or other organic solvents, whether performed by a contractor, service company, or yourself, are excluded from this warranty.

ZEAFIVE responsibility under this limited warranty is limited to only to replacement parts and no other costs.

ZEAFIVE will not be responsible for labor charges and/or damage incurred by installation, repair, or replacement, nor for any indirect incidental or consequential damages, losses, injury, or costs of any nature relating to this product.

Except as provided by law, this limited warranty is instead of and excludes all other warranties, conditions, and guarantees, whether expressed or implied, statutory or otherwise, including without restriction those merchant ability of fitness for use.

## RESPONSIBILITIES OF OTHERS

Inspecting the unit before installation is the responsibility of the installer or building contractor who acts on behalf of the user. They are responsible for ensuring the unit is free of defects or damage. Notices are placed on and in the unit and on the shipping carton advising the installer of this responsibility. In the event of a problem, the unit must not be installed.

ZEAFIVE is not responsible for failures or damage that could have been discovered, repaired, or avoided by proper inspection and testing before installation.

Damage occurring in transit is the responsibility of the carrier. The user or installer **MUST** open the crate and inspect the unit for damage when it's delivered. If damage is discovered, it must be reported immediately to the seller and the carrier in writing, and an inspection requested. Failure of the carrier to respond should be reported to the seller and the carrier. Your freight claims should be filed promptly thereafter.

## LIMITATIONS AND EXCLUSIONS

This warranty does not cover instances of negligence, misuse, abuse, improper installation, carelessness, accident, hard water or mineral deposits, exposure to corrosive materials, misapplication, damages caused by improper maintenance, alteration of the product, or failure to follow care or installation instructions enclosed with your product.

This warranty is void if the ZEAFIVE is subject to alteration, or if repairs are attempted by anyone other than an authorized agent of ZEAFIVE. This warranty does not extend to plumbing or components installed by dealers, installers or by any party other ZEAFIVE.

ZEAFIVE will not be liable for loss of use of the ZEAFIVE inconvenience, or any other incidental or consequential costs, expenses, or damages. Please note that some states do not allow the exclusion or limitation of incidental damages.

## DISCLAIMER

Except as expressly provided, there shall be no warranty or obligation, express or implied, oral or statutory. No dealer or other person has the authority to make any warranties or representations concerning ZEAFIVE or its products. In no event shall ZEAFIVE be held responsible for any such warranties or representations.

## WARRANTY SERVICE

NOTE: When requesting a warranty, be sure to have the following:

- Copy of original invoice
- Date of installation
- Description and pictures of the defect
- Model number or description of the model

To obtain warranty service and replacement parts, please contact ZEAFIVE Customer Service. ZEAFIVE will determine whether to repair or replace your product, issue a refund, or issue a credit.

WARNING: Content may contain sharp and other possibly harmful pieces and may cause hazard to children and adults, ZEAFIVE is not responsible in any way for personal damage.

# HOME SERVICES



INSTALLATION VIDEO

**Missing Part or Defective?**

✉ Email: [service@bestgosupplychaininc.com](mailto:service@bestgosupplychaininc.com)