

INSTRUCTION
ANWEISUNG

取扱説明書
INSTRUCTION

사용설명서

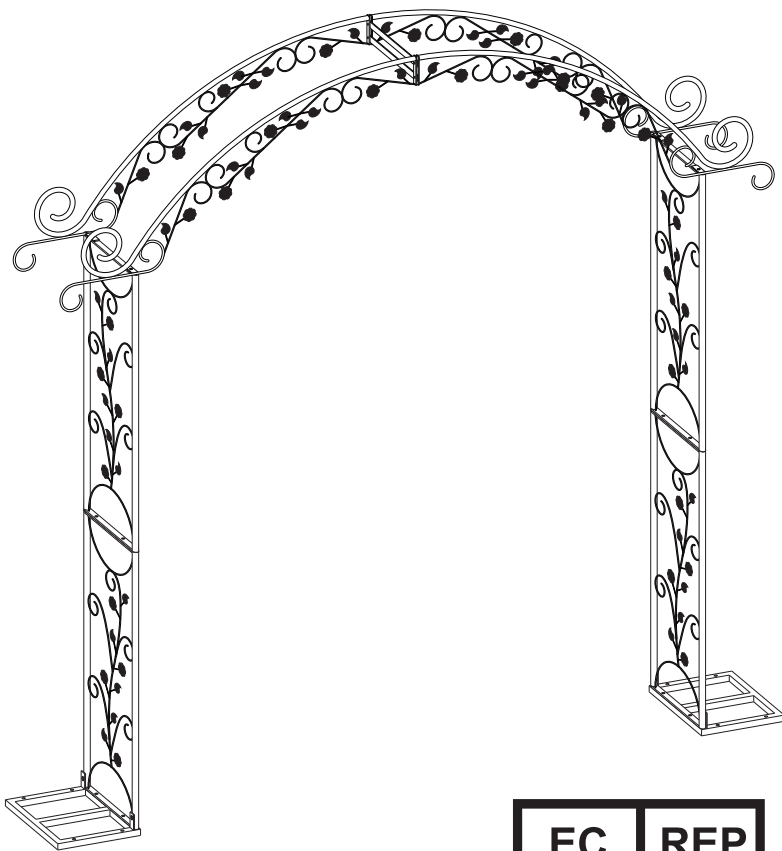

FR



ÉTUI



FR

Ce meuble se recycle,
s'il n'est plus utilisable.
déposez-le en déchèterie.
Notice à trier.
Pour en savoir plus:
www.quefairedemesdechets.fr

EC REP

C&E Connection
E-Commerce (DE) GmbH
Zum Linnegraben 20, 65933,
Frankfurt am Main, Germany
info@ce-connection.de

UK REP

Company: YH Consulting Limited
Address: C/O YH Consulting Limited Office 147,
Centurion House, London Road,
Staines-upon-Thames, Surrey, TW18 4AX

A *2

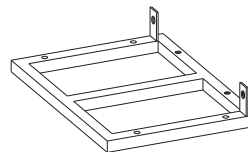

B *2



C *2



D *2

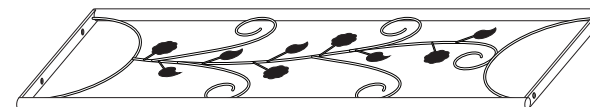

E *2

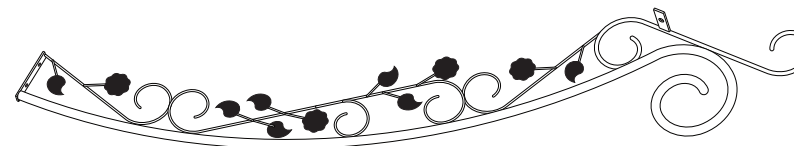

F *2

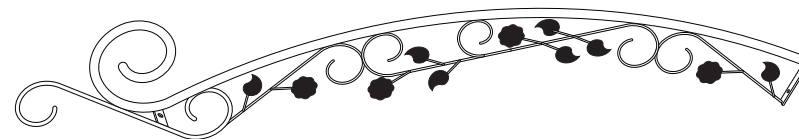

G *12



M6 *10MM

H *4



M6 *15MM

Y *4

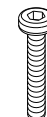

M6 *28MM

J *16



M6

K *8



L *1



M *1



1

- G *8
- Y *4

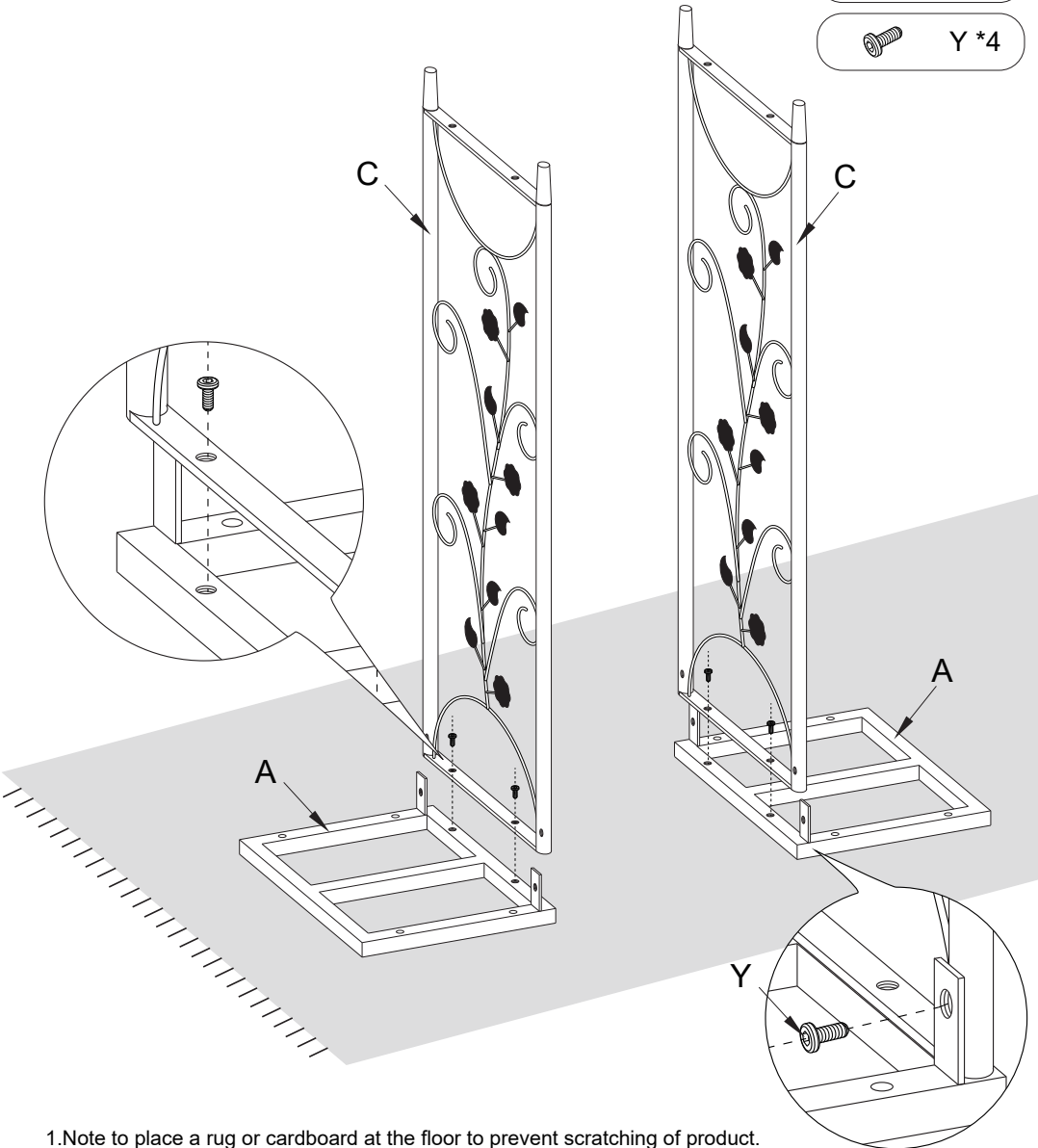

2

- G *4
- J *4

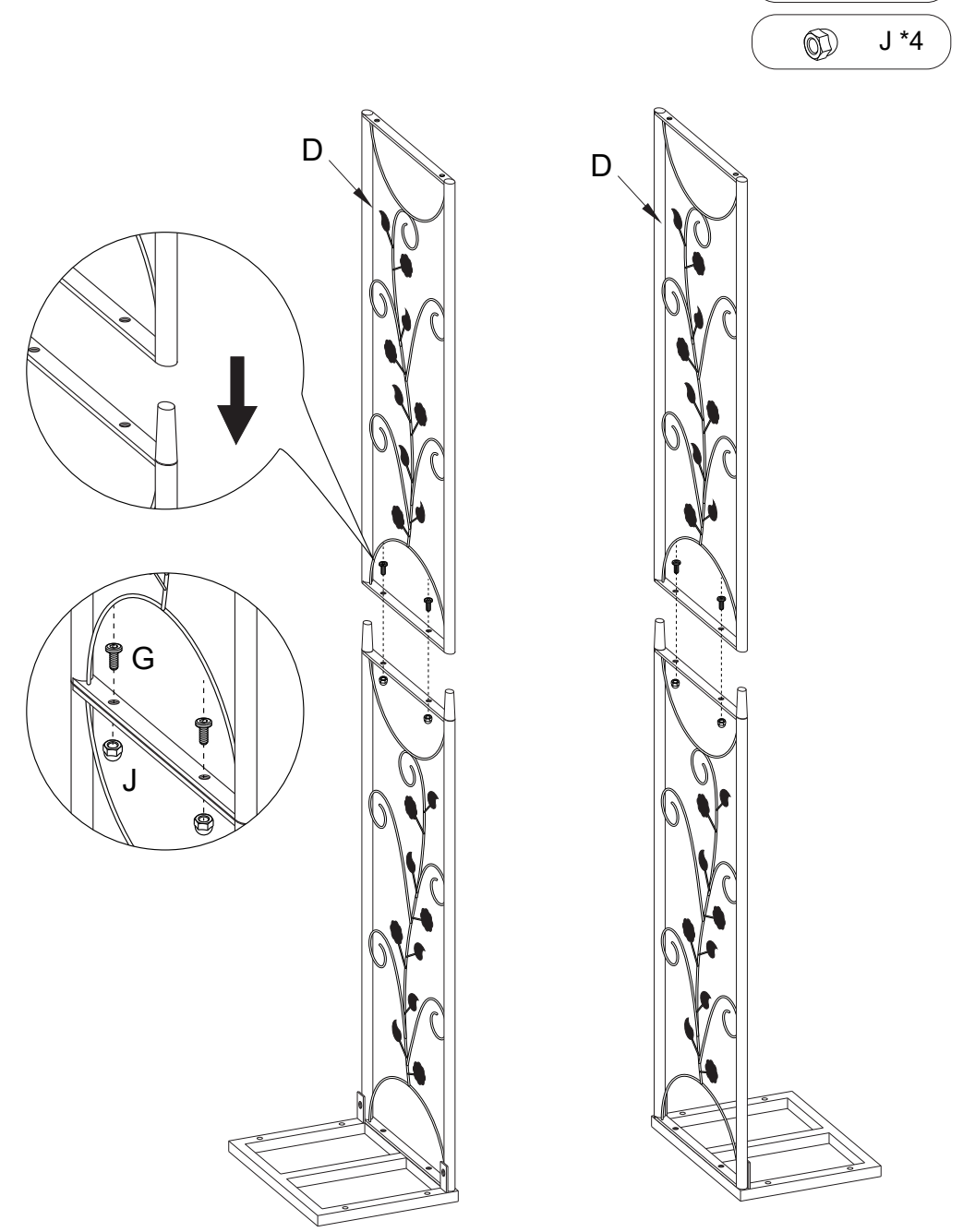

- 1. Note to place a rug or cardboard at the floor to prevent scratching of product.
- 1. Legen Sie bitte bei der Installation einige Stoffe oder Pappen auf den Boden, um den Boden vor Kratz zu schützen.
- 1. 傷を防ぐために、組み立てはダンボールやカーペットなどの上にして下さい。
- 1. Mettez un tapis ou un carton au sol pendant l'installation pour éviter de rayer le cadre en fer
- 1. 긁힘을 방지하기 위해 조립은 골판지나 카펫 등 위에 놓고 진행하십시오.

3

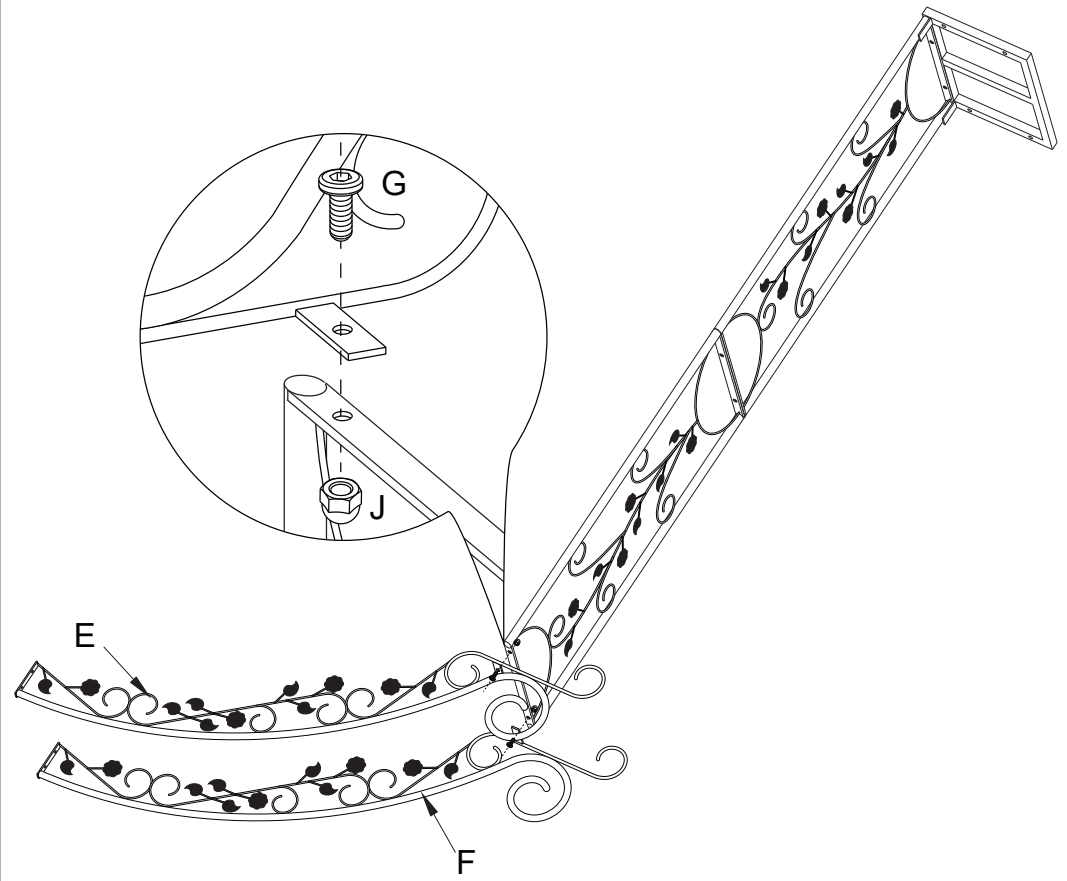
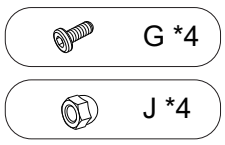

- ▶ Placing on the floor for installation as the stand is tall and heavy
- ▶ Der Holzrahmen ist höher und schwerer, bitte installieren Sie ihn auf dem Boden
- ▶ L'arche en bois est grand et lourd, veuillez la mettre sur le sol pour l'installer
- ▶ 나무틀들은 크고 무거워 지면에 두고 설치하세요.

4

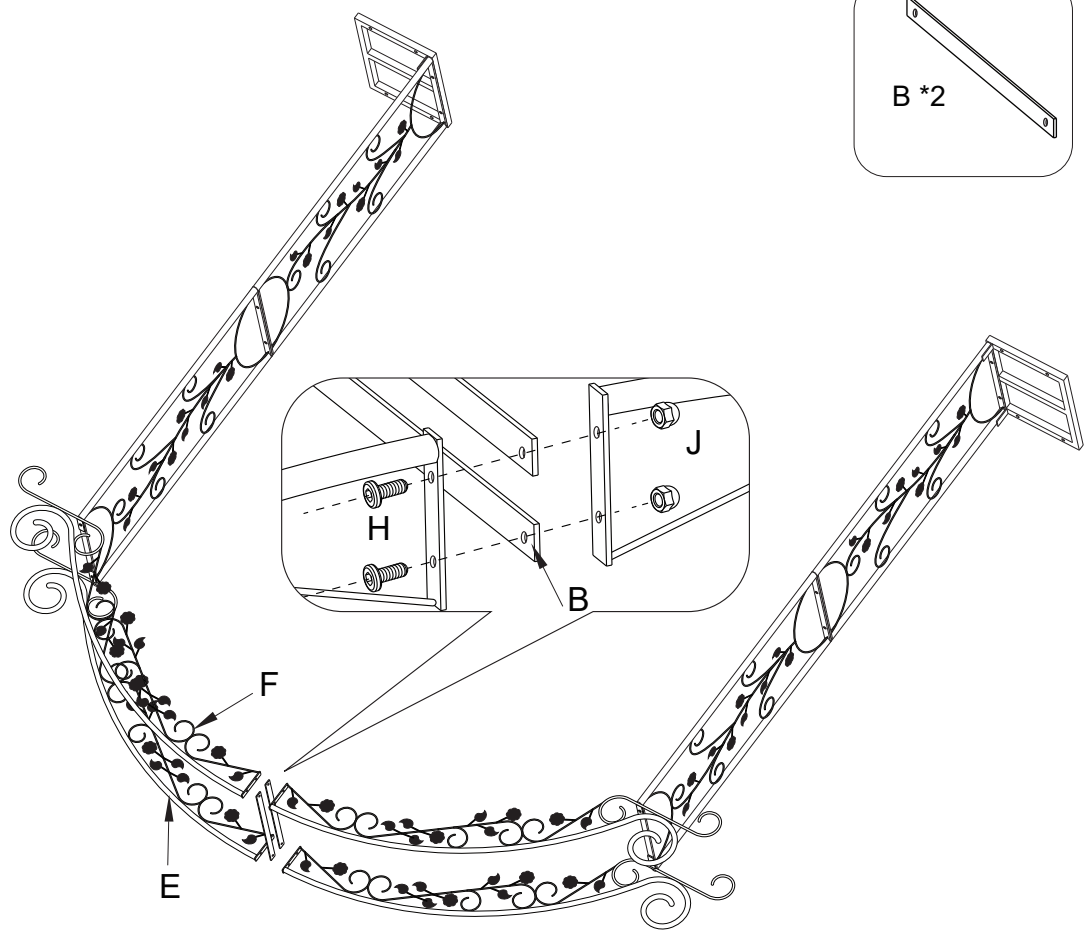
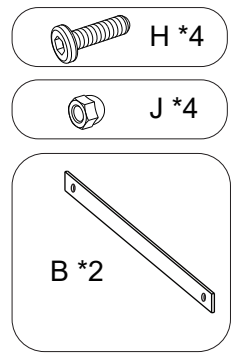

- ▶ Placing on the floor for installation as the stand is tall and heavy
- ▶ Der Holzrahmen ist höher und schwerer, bitte installieren Sie ihn auf dem Boden
- ▶ L'arche en bois est grand et lourd, veuillez la mettre sur le sol pour l'installer
- ▶ 나무틀들은 크고 무거워 지면에 두고 설치하세요.

5

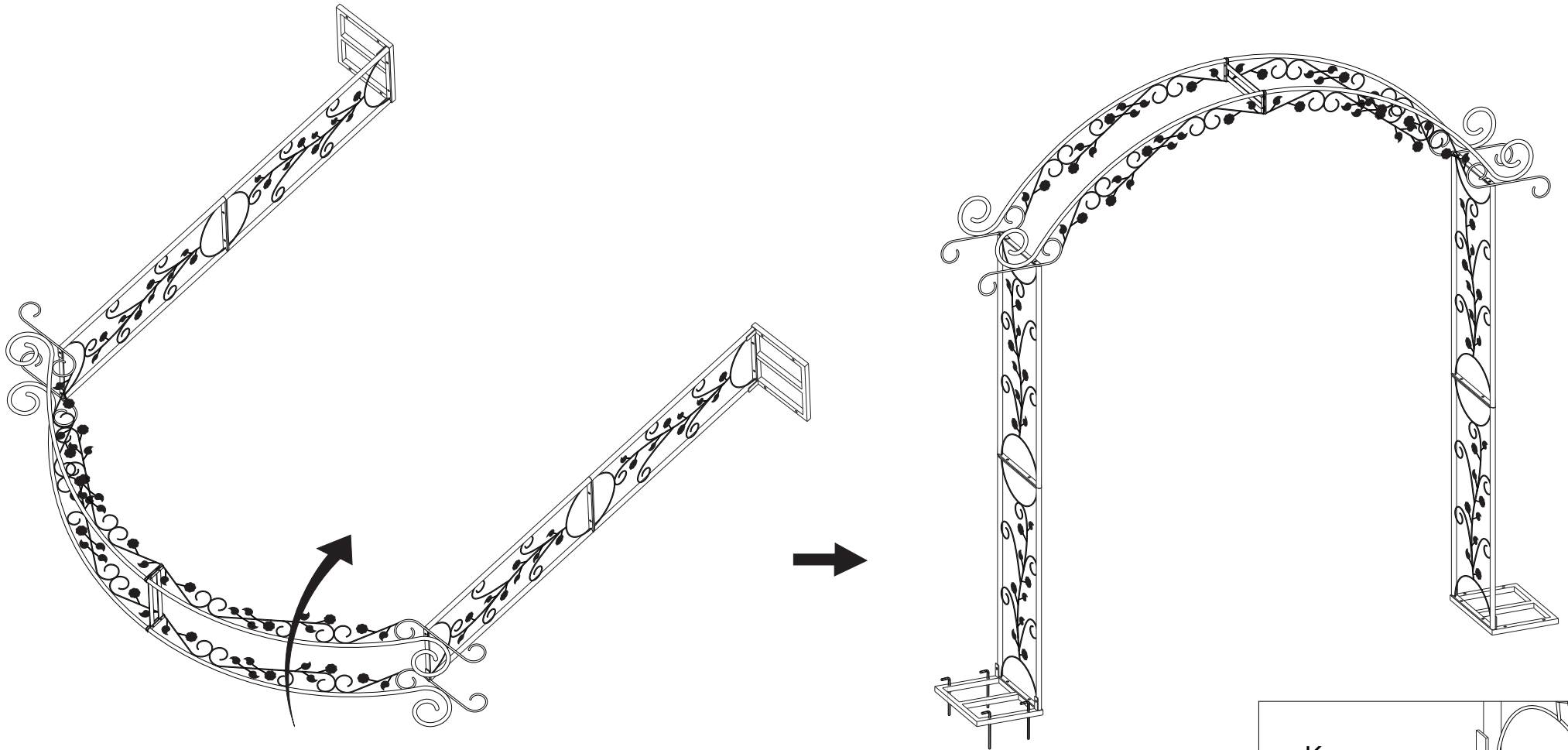

- ▶ Tighten all the screws after hold the stand up.
- ▶ Der Holzrahmen ist schwer, zuerst die Schrauben mit Werkzeug anziehen und dann nach der Installation auf dem Boden aufstellen
- ▶ Une fois l'arche assemblée, veuillez la soutenir pour serrer les vis
- ▶ 나무틀은 크고 무거우며 지면에서 설치해 올려 나사를 조입니다

