

6x6ft DOG KENNEL

DELIVERED FLAT PACKED
EASY TO INSTALL SECTIONS...

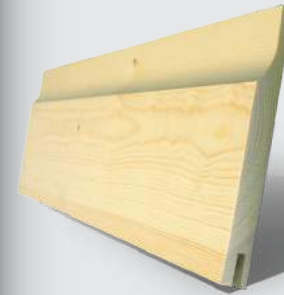

Pressure Treated
Tanalised Timber for
Longer Lasting Life!



SHEDS • SUMMER HOUSES • KENNELS

PRESSURE TREATED TANALISED TIMBER

ASSEMBLY MANUAL



Order Supplied with:
4.0 x 70mm
Easy Drill Screws

Kennel with Run Area

Requires a minimum build area.*
Please see details below.

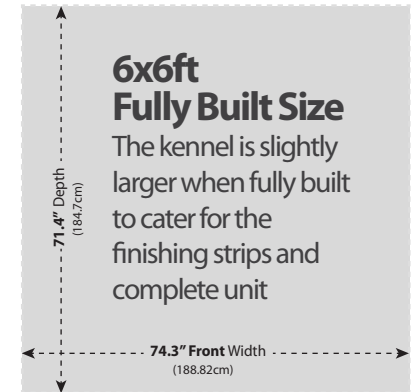

*Actual finished dimension area 74.3" x 71.4"

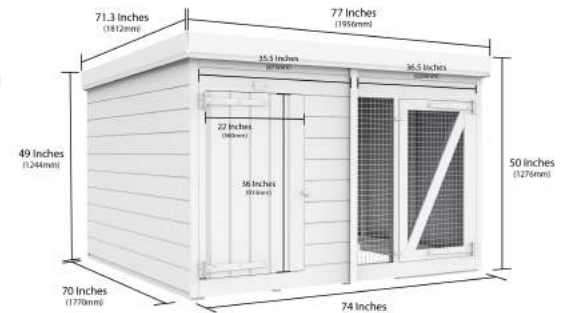

Ready to Build Dog Kennel

Contents are in assembling order.

6x6ft Dog Kennel Check List

Your delivery should contain the following:



2 Persons Required



Pressure Treated Timber

Thank you for purchasing your Dog Kennel from Total Sheds.

All of our Kennels are made from only the finest selected timber which are (Tanalised), specially pressure treated for a longer and lasting durable life span to the elements.

PLEASE NOTE: Use extreme caution when using any tools. Always wear safety gear where necessary. It is advisable that at least 2 or more persons assemble the kennel for health and safety purpose. We are not responsible for any injuries caused whilst assembling this kennel.



1X Kennel Floor



Page 3

2X Side Blocks



Page 3

2X Back Panels



Page 4 & 5

1X Side Panel Left



Page 4

1X Side Panel Right



Page 5

1X Pop Hole



Page 6

1X Front Left



Page 6

1X Front Right

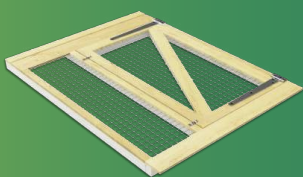

Page 7

6X Corner Strips



Page 7

2X Roofs Panels



Page 8

3X 7ft Roof Felts

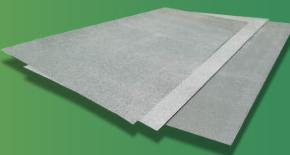

Page 9

8X Felt Strips



Page 9

DELIVERED FLAT PACKED EASY TO INSTALL SECTIONS...

Each Kennel is carefully prepared in sections. Making the assembly process as easy as possible for you. Please follow our simple step-by-step guide and have your dog's new home built in no time!

Tools Required to Assemble:



HAMMER



DRILL DRIVER



STANLEY KNIFE

Supplied with 4.0x70mm EASY DRILL SCREWS



STEP • 1

SET THE KENNEL FOUNDATION

KENNEL FLOOR BASE

Set the base for the kennel floor to build on.

Place floor down into the required position/area. (7x7sqft recommended)

TIPS & ADVICE: It is always good to position your kennel on a solid foundation.

Slabs or Concrete areas are ideal.



STEP • 2

FLOOR BLOCK x1

ATTACH FLOOR BLOCK 1

Screw in to left of floor side as shown.



FIX SIDE POST TO FLOOR EDGE WITH LARGE SCREWS



Floor Block
63mm x 38mm

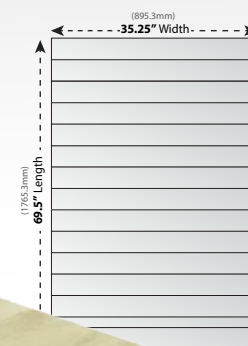

● = Drill Points using screws provided as shown

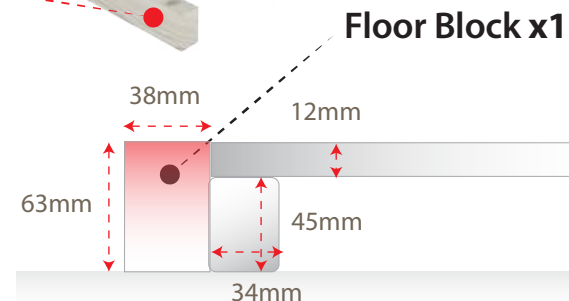

STEP • 3

ATTACH BACK PANEL 1 of 2

Position Back Panel 1

Set within the floor planks, sitting just off the rear edge.

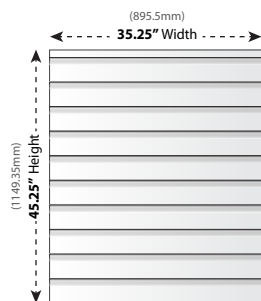

DO NOT SCREW DOWN THE PANELS TO FLOOR JUST YET!

Screw only the vertical panels to create a standing frame first, allowing room for adjustments.

STEP • 4

LEFT SIDE PANEL

Position Left Side Panel

Now place the Left Side Panel flush against the Back Panel Post.

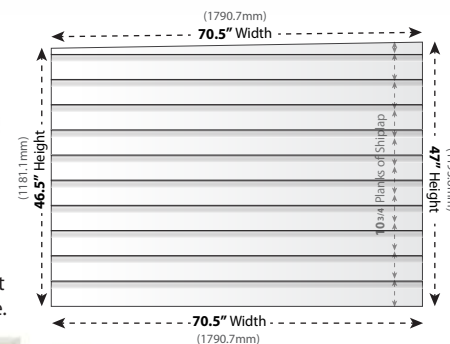

Set side panel left against back panel post as shown on this image.

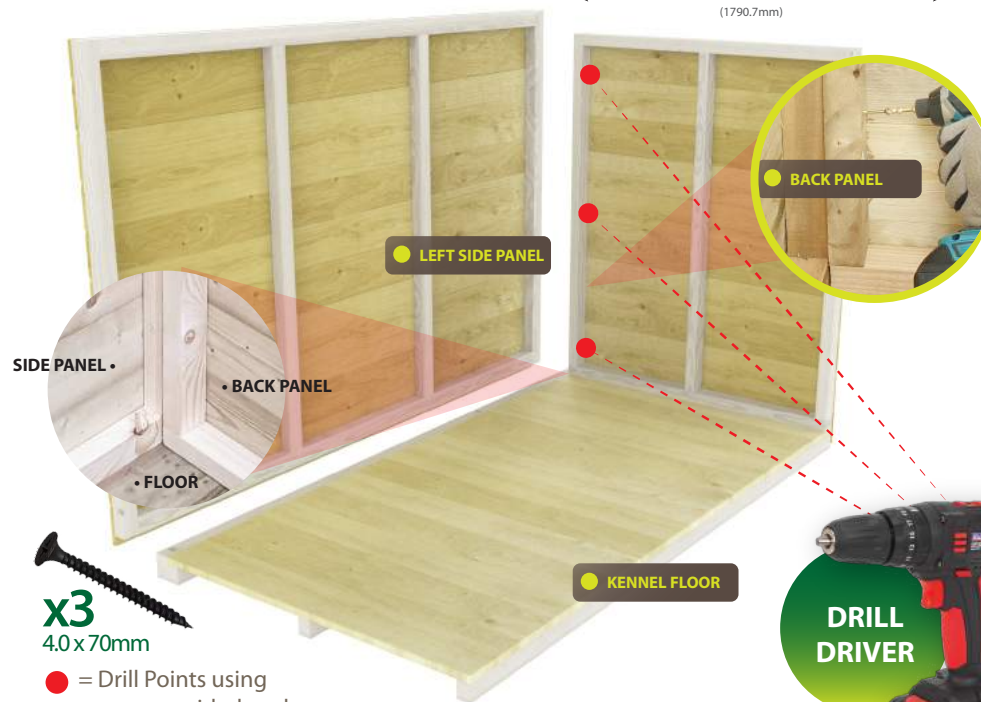

x3
4.0 x 70mm

● = Drill Points using screws provided as shown



DRILL DRIVER

STEP • 5

ATTACH BACK PANEL 2 of 2

Attach Back Panel 2

Use the 2nd Floor Block to raise the back panel height then screw against 1st panel side.



Position the 2nd back panel in place as shown on diagram below. The back panel 2 must be the same height as the 1st back panel which is 63mm from the ground to back panel frame bottom.

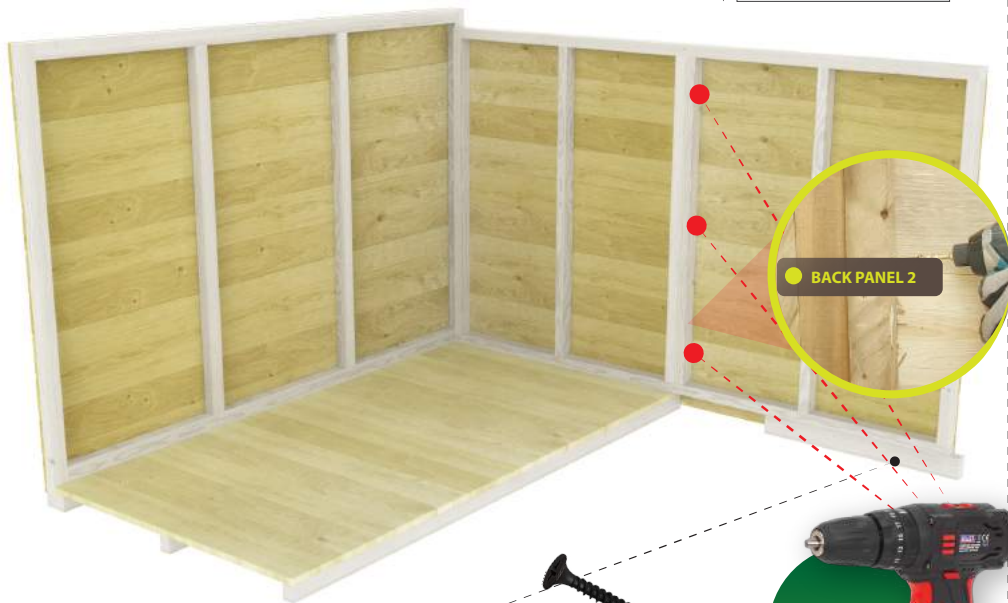

Using the Floor Block Posts, elevate the 2nd back panel and screw in sides to secure againsts the 1st back panel side post as shown here.

x3
4.0 x 70mm

● = Drill Points using screws provided as shown



DRILL DRIVER

STEP • 6

RIGHT SIDE PANEL

Attach Right Side Panel

Now attach the Right Side Panel by placing against 2nd back panel side as below.

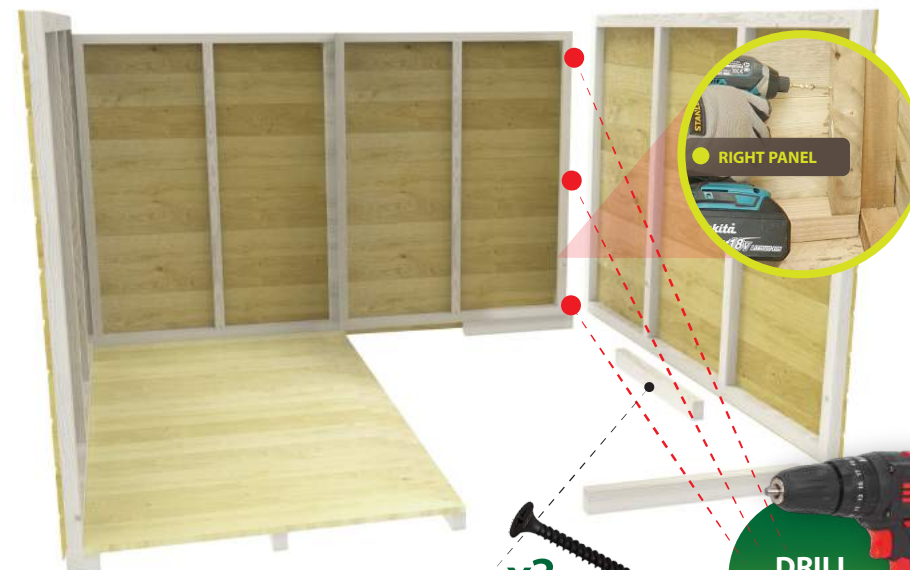
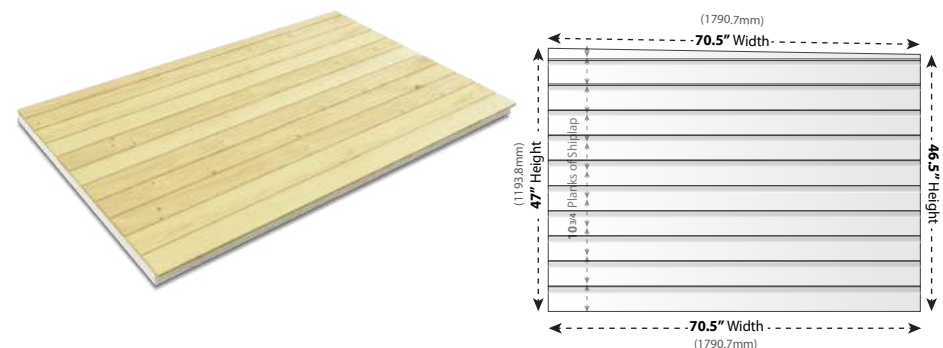

Using the Floor Block Posts, elevate the right side panel and screw in sides to secure againsts the 2nd back panel side post as shown.

x3
4.0 x 70mm

● = Drill Points using screws provided as shown



DRILL DRIVER

STEP • 7

POP HOLE

Place Pop Hole Panel

Set within the floor planks sitting flush with front and rear panel edges and floor.

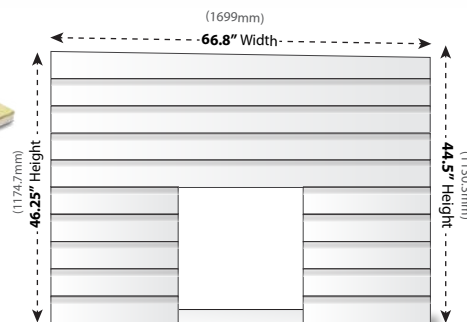

● = Drill Points using screws provided as shown



STEP • 8

ATTACH BACK FRONT PANEL A

Front Door Panel

Now set the 1st of the front panels. Position the solid door panel like below.

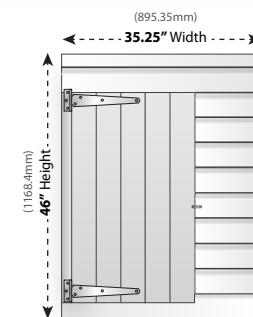

● = Drill Points using screws provided as shown

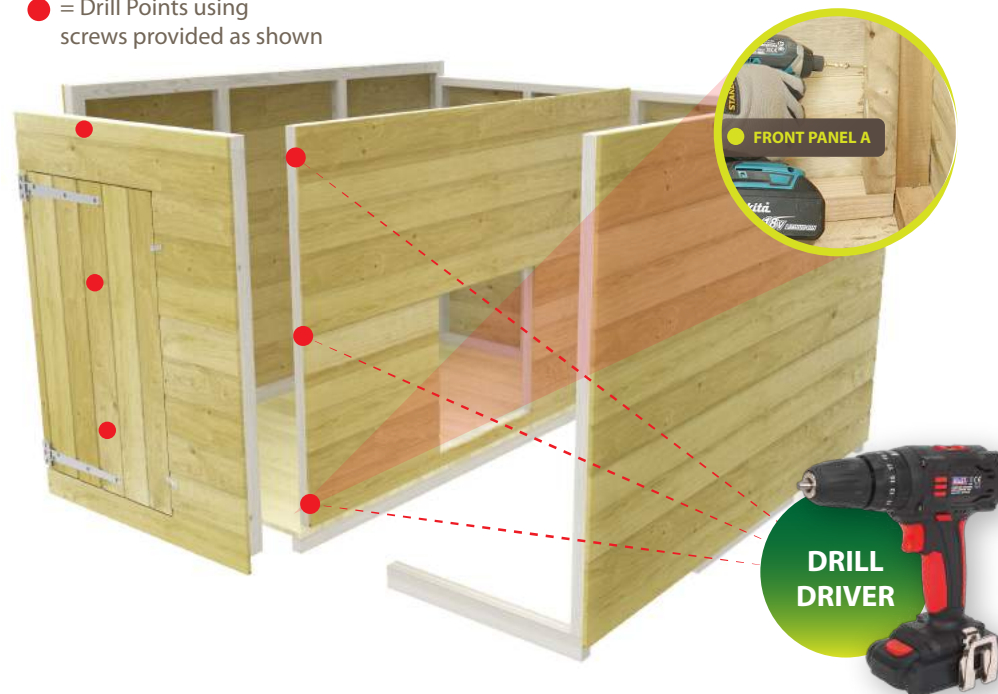

STEP • 9

ATTACH BACK FRONT PANEL A



Front Mesh Panel

Now place the front right panel between left front and right side panel edges as shown.

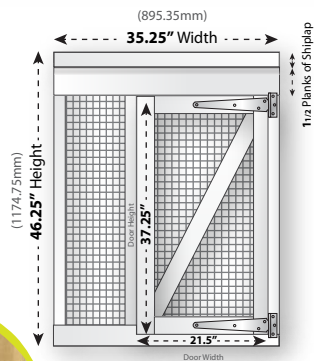

FRONT PANEL B

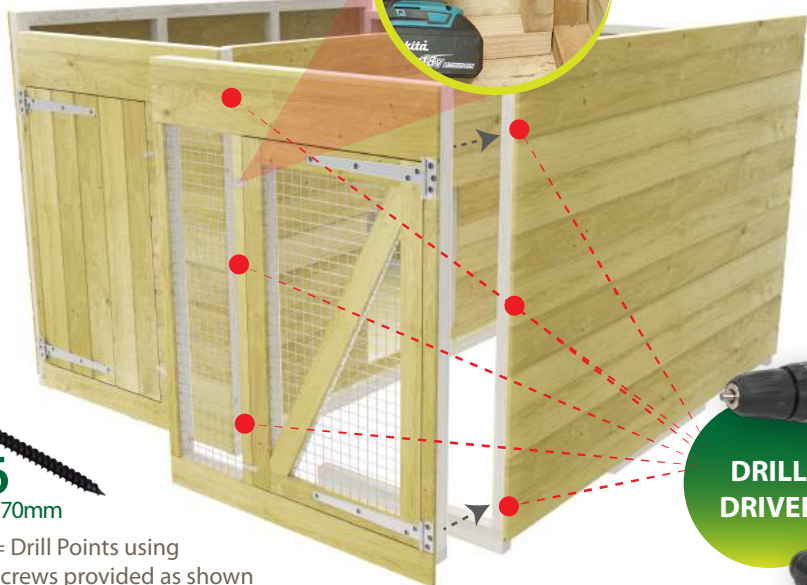

x6
4.0 x 70mm

● = Drill Points using screws provided as shown

DRILL DRIVER



STEP • 10

SIDE STRIPS

Attach Corner Strips

Now finish off the panels edges with the corner strips provided.



x6

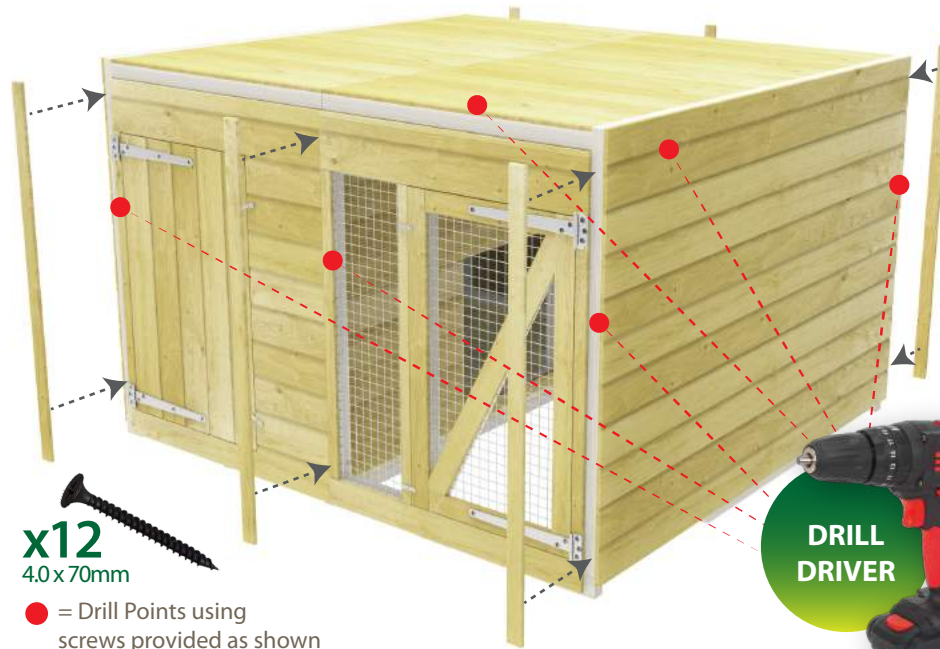
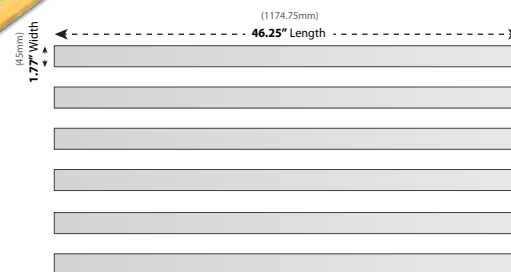

x12
4.0 x 70mm

● = Drill Points using screws provided as shown

DRILL DRIVER



STEP • 11

PLACE ROOF SECTION 1

1st Roof Section

Now place the 1st of the 2 roof panels as shown in the diagram below.



x4
4.0 x 70mm

● = Drill Points using screws provided as shown

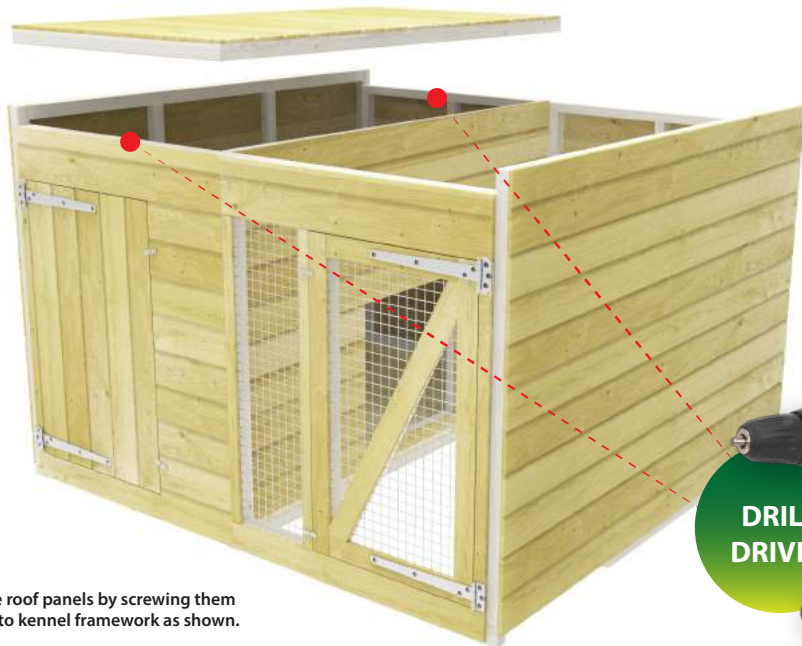
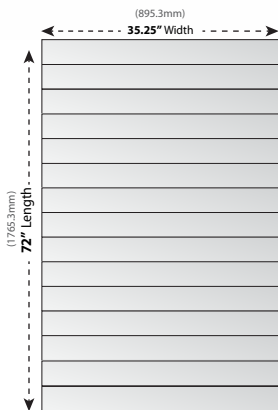

DRILL DRIVER

Secure roof panels by screwing them down to kennel framework as shown.

STEP • 12

PLACE ROOF SECTION 2

2nd Roof Section

Now place the 2nd roof panel as shown in the diagram below.

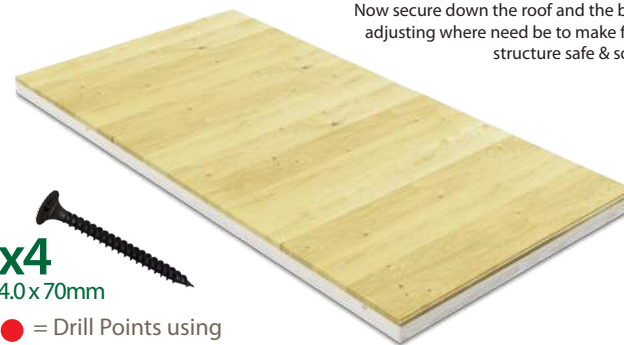

x4
4.0 x 70mm

● = Drill Points using screws provided as shown

Now secure down the roof and the base adjusting where need be to make final structure safe & solid.

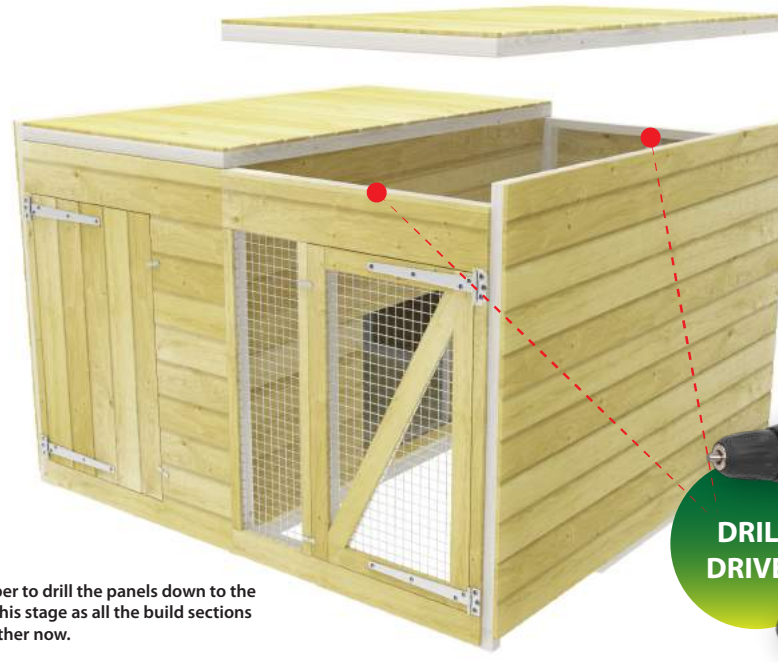
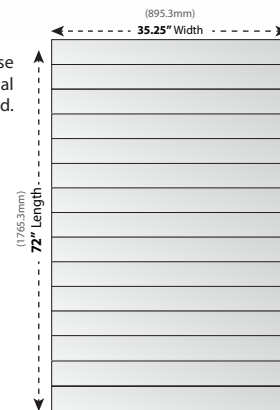

DRILL DRIVER

Remember to drill the panels down to the floor at this stage as all the build sections are together now.

STEP • 13

APPLY ROOF FELT SHEETS x3

40kg Mineral Felt Roof

You will be provided with 3 lengths of high quality roof felt. Start with lower end of roof first.



1st Sheet at rear of roof

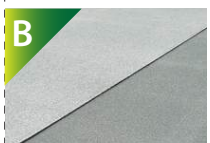
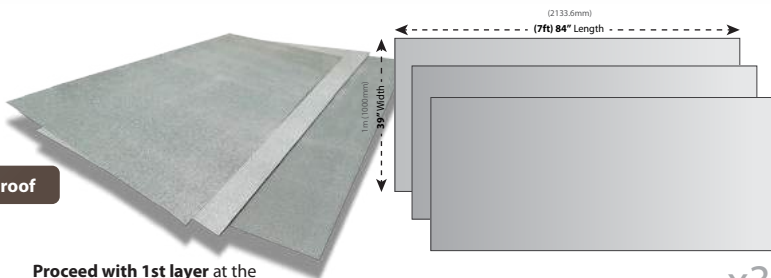

2nd Sheet higher above

Proceed with 1st layer at the rear lowest point of roof, then overlay the other 2 sections.

x3



3rd sheet on top front



Trim edges with 3" over

TACKS PROVIDED



Fold & tack edges neatly

After cutting away the excess felt, neatly fold over the edges and secure each section down by tacking them to the kennel sides. **PROTECT YOUR KENNEL AGAINST THE RAIN & ELEMENTS.**

STANLEY KNIFE

HAMMER

STEP • 14

FINISH OFF WITH FELT STRIPS

Finishing Touches!

To hide the tacked felt edges add the felt strips along the top edge of roof as shown.

*Sections may come longer than required. Please saw down.



Create a neat and tidy roof finish hiding the rough edges and tacks. Measure the sides for a perfect cut and finish!

Carefully check all the panels are fitted well and the kennel is secure and stable.

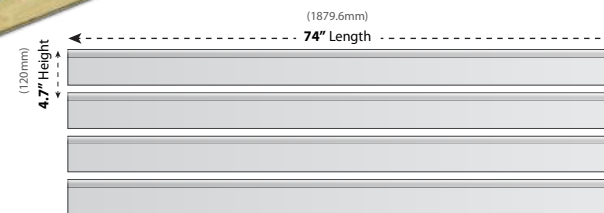

You are almost done building your kennel!

x8

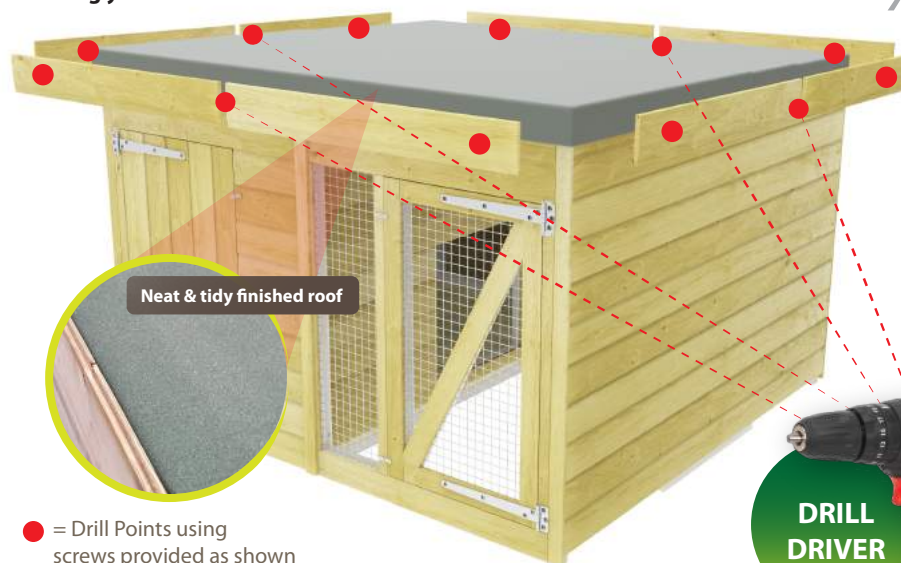

Neat & tidy finished roof

● = Drill Points using screws provided as shown

You may use optional Diamond Cap to cover felt strip join
CONGRATULATIONS - YOUR DONE!

DRILL DRIVER

