

INSTALLATION MANUAL

CHANDELIER

Model No.:

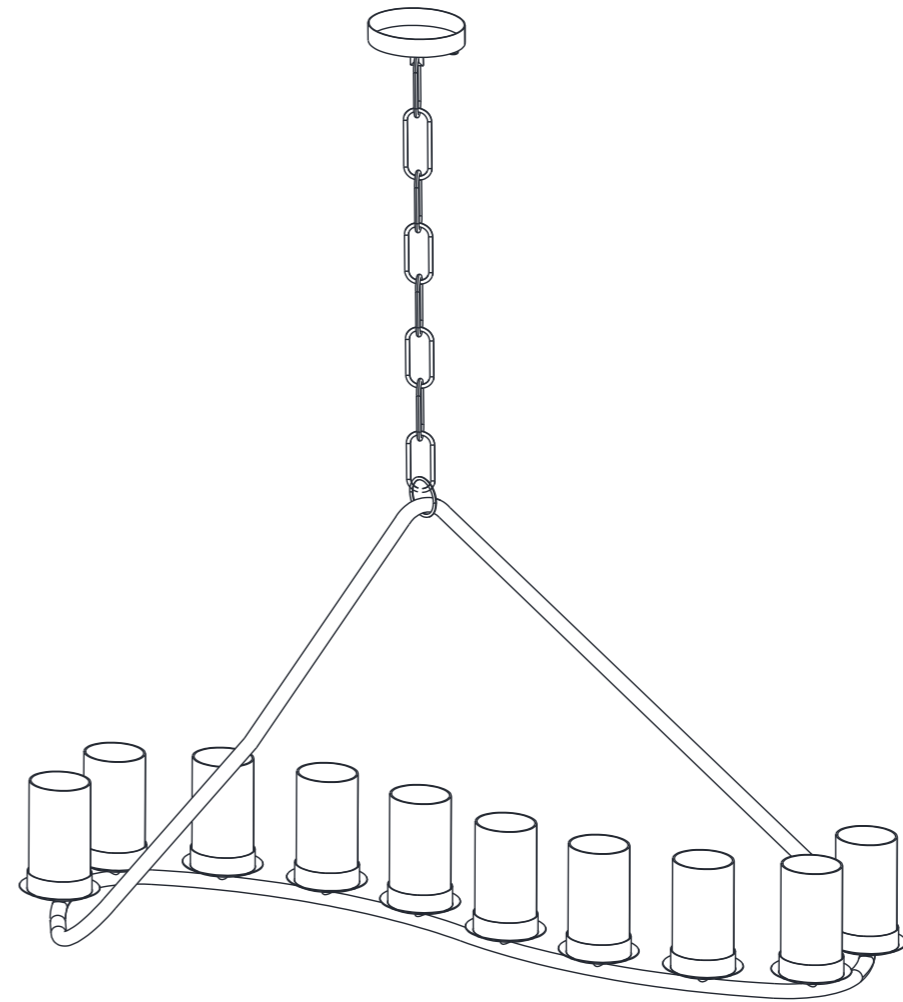

TOOLS REQUIRED



Ladder

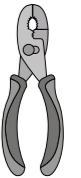

Pliers

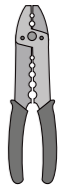

Wire
Strippers

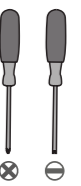

Screwdrivers







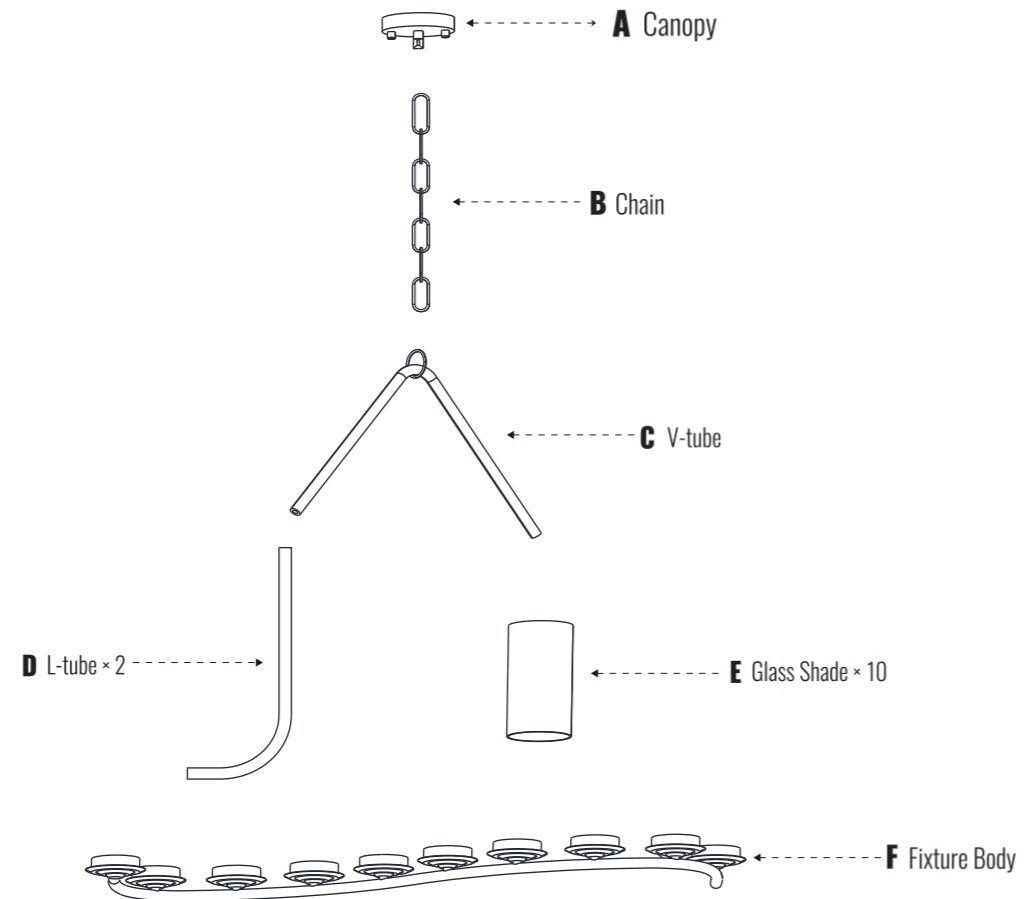

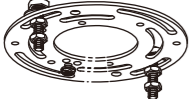

Power Drill

PACKING LIST

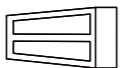

Note: This product supports dimmer switches but must be used with dimmable bulbs; otherwise, it may cause the bulbs to flicker.

INSTALLATION KIT

| | | | |
|--|--|--|---|
| AA  Mounting Bracket 1× | BB  Ground Screw 1× | CC  Wire Nut 4× | DD  Wood Screw 4× |
| EE  Plastic Anchor 4× | FF  Outlet Box Screw 2× | GG  Lamp Body Screw 10× | HH  Knurled Nut 2× |
| II  Gloves 1× | | | |

Note:

1. Some extra hardware may be included. The quantity listed above is the number required for installation.
2. The ground screw (BB) is pre-installed on the mounting bracket.
3. The mounting bracket (AA) and knurled nut (HH) are pre-installed on the canopy (A).

7. Install the Bulbs

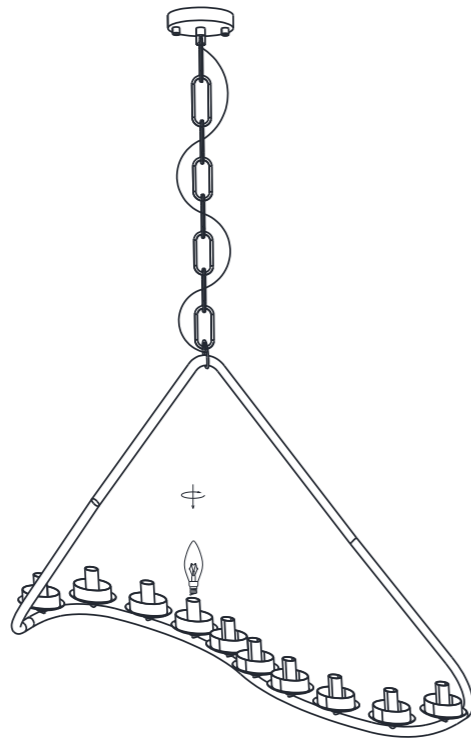

E12 x 10, Max 40W each, LED recommended (not included).

Note: To achieve dimming functionality, you need to use dimmable bulbs and a dimmer switch.

8. Install the Glass Shade

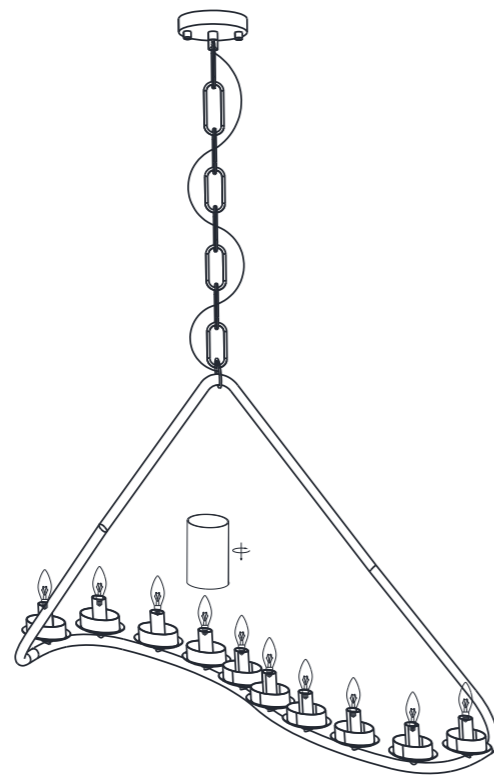

Place the Glass Shade (E) on the lamp body.

INSTALLATION

1. Install the Lamp Body

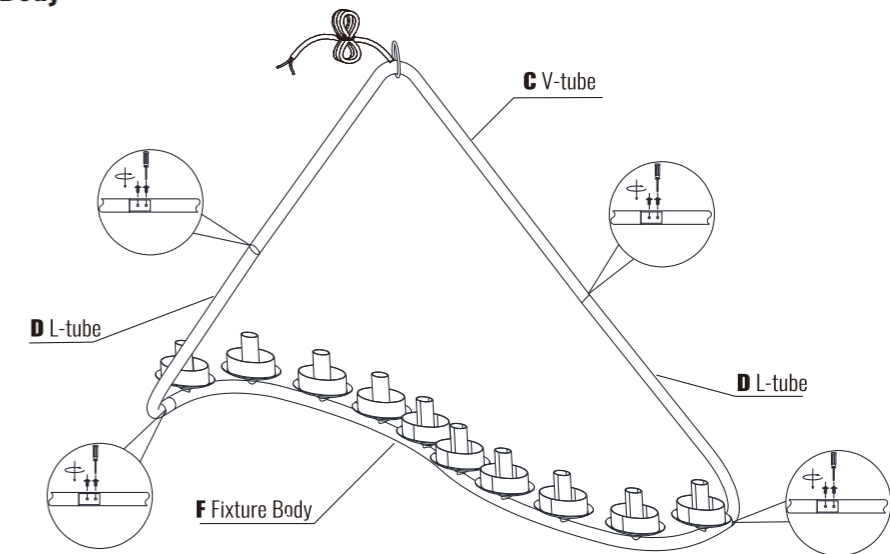

Use the Lamp Body Screws (GG) to tighten the V-tube (C), L-tube (D), and fixture body (F) to form a unit as shown.

2. Install the Mounting Bracket

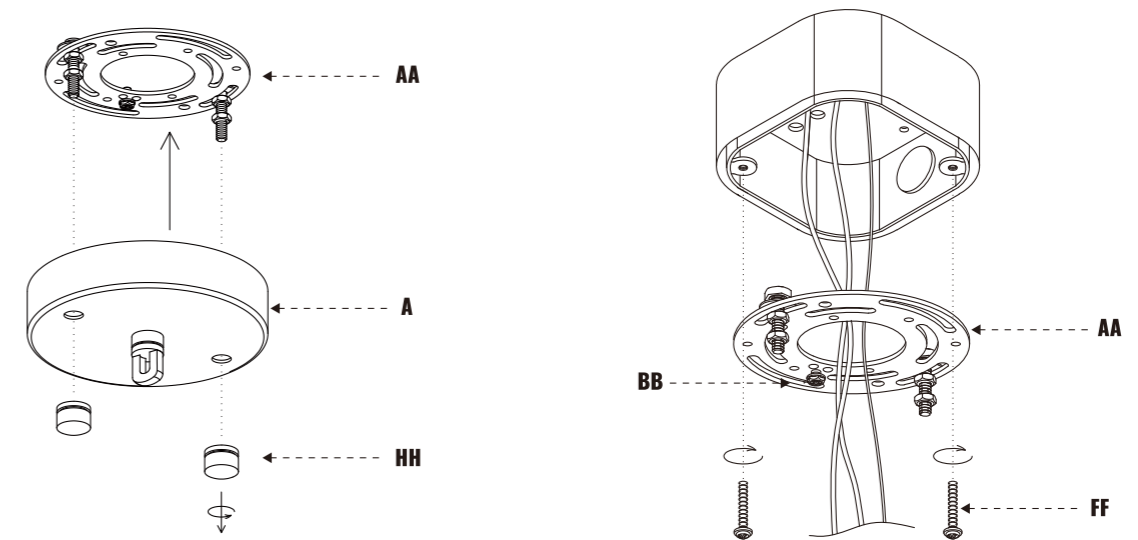

Step 1: Loosen the Knurled Nut (HH) from Canopy (A), take out the Mounting Bracket (AA).
Step 2: Take off the screws from the outlet box, and secure the Mounting Bracket (AA) onto the box with the screws taken off or Outlet Box Screw (FF).

3. Install the Chain

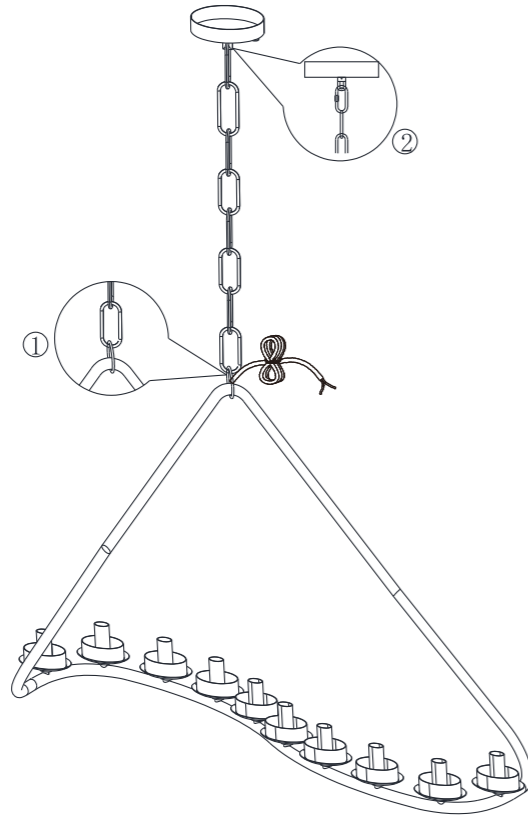

Open the quick link on Chain (B), then connect the quick link on both ends of Chain (B) to the Canopy (A) and the fixture loop of the lamp body, and finally lock the quick link tightly.

4. Pass the Wire

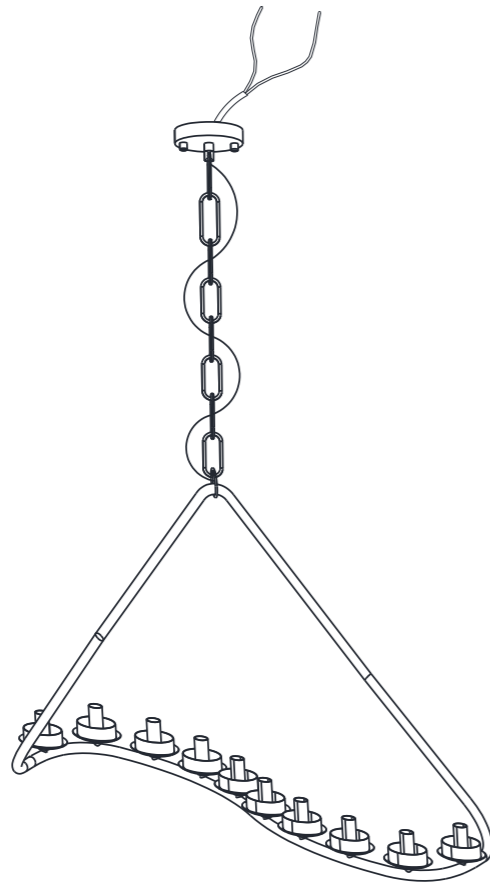

Pass the wires through Chain (B) and Canopy (A) as shown.

5. Connect the Wire

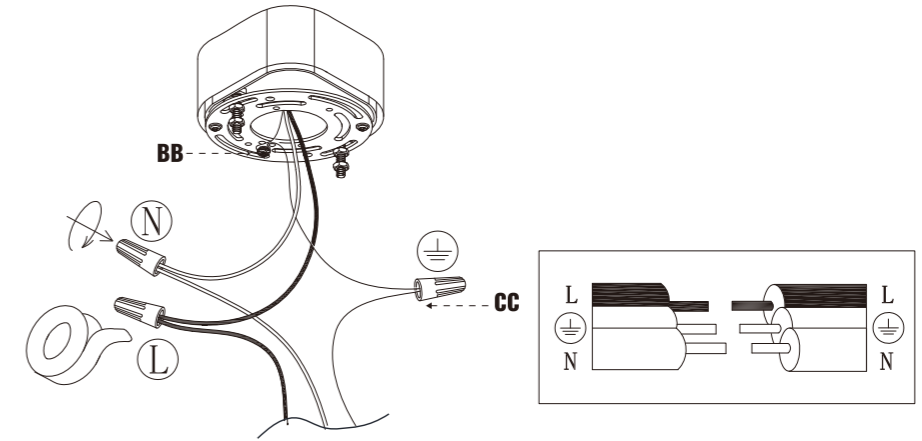

Step 1: Wrap the ground wire from the outlet box around the Ground Screw (BB) on the Mounting Bracket (AA), and then connect the ground wire from the fixture to the ground wire from the outlet box.
Step 2: Connect the wires from the fixture to the house supply wires with Wire Nut (CC), neutral wire (white) to neutral wire, and hot wire (black) to the hot wire. Wrap the connection with electrical tape.
Step 3: Spread apart the wires so that the hot wires are on one side of the outlet box and the neutral wires are on the other.

6. Fix the Canopy

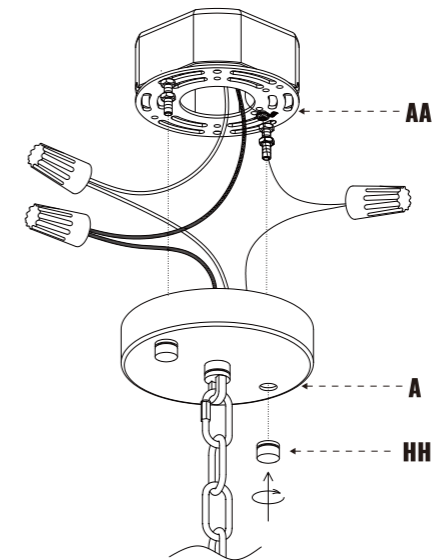

Fix the Canopy (A) onto the Mounting Bracket (AA) with Knurled Nut (HH).