

Wayfair

Hardware



A
8x

Tools Required

Power tools NOT recommended



1x

Components

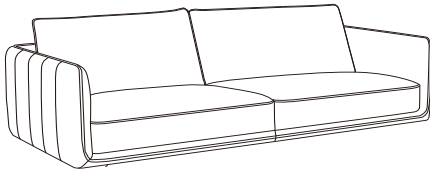

B
1x

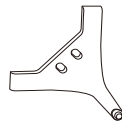

C
4x



D
1x

Assembly

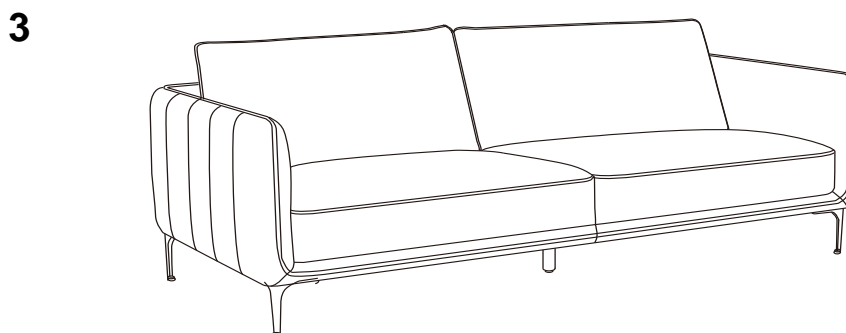
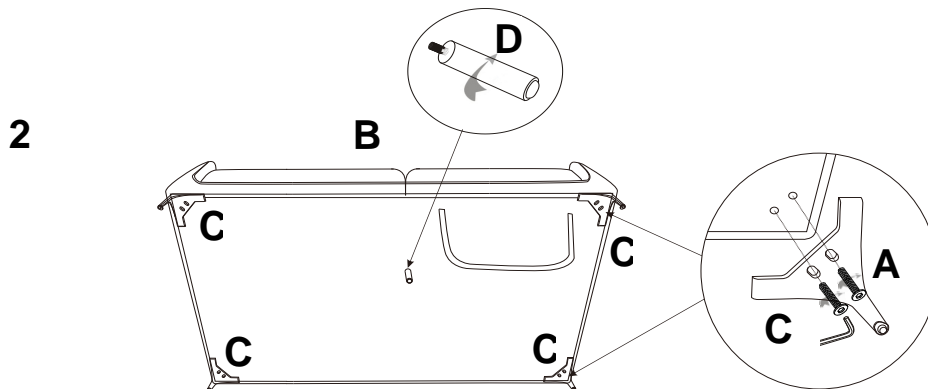
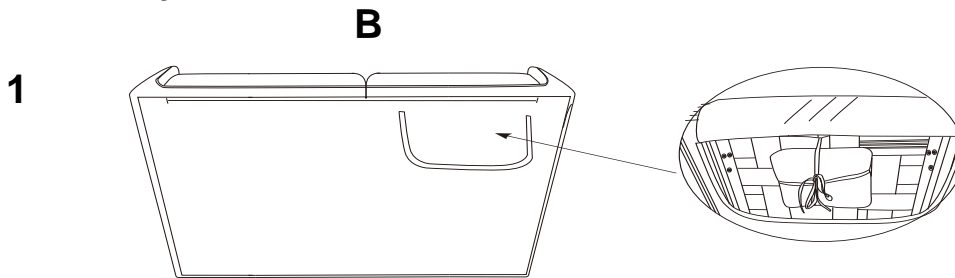

Characteristics of Leather

Genuine leather products develop a patina as they age over time and use. This is completely natural and adds to the beauty and uniqueness of your furniture. There are also slight dye lot variations in every group of leather hides we acquire. It is important to note that, due to these reasons, we cannot guarantee that furniture purchased at different times will match exactly.

With normal use, your leather upholstery will begin to take on natural characteristics such as slight folds and creases as the leather relaxes. This is natural and adds appealing character to your furniture.

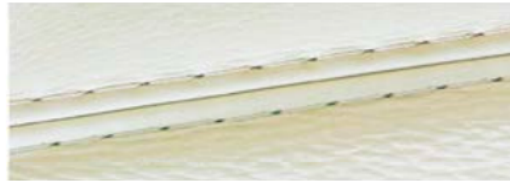

Grain Variation

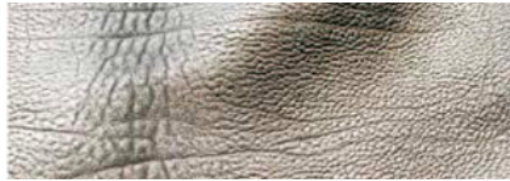

Wrinkles



Healed Scar



Slight Shade Variation

CLEANING GUIDELINES



LEATHER

Leather is one of the most durable upholstery materials. However, leather still needs regular care and cleaning to maintain its natural beauty and extend the product life.

For minor liquid stains, quickly soak up the spill by carefully blotting up the liquid with a clean white cloth. Let the area air dry. Most spills can be blotted up and dry very easily.

If a liquid or other substance leaves a stain or water mark, we recommend contacting a professional cleaning service. Never use cleaning solutions on your leather furniture.