

# ASSEMBLY INSTRUCTIONS

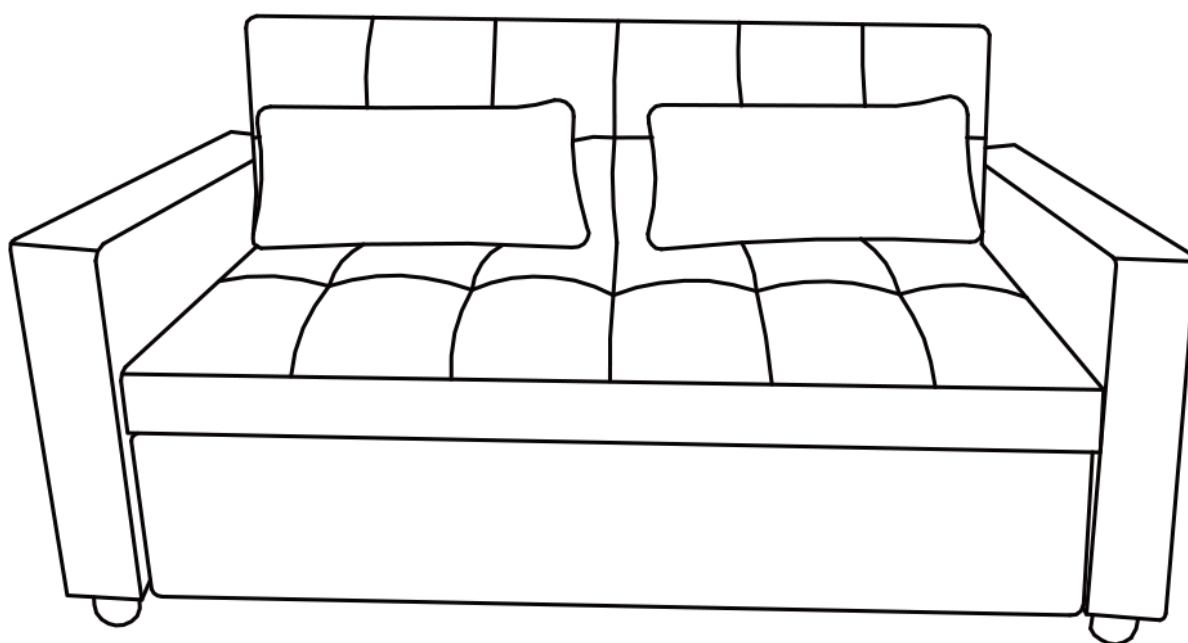



————— Thank you for choosing our product!

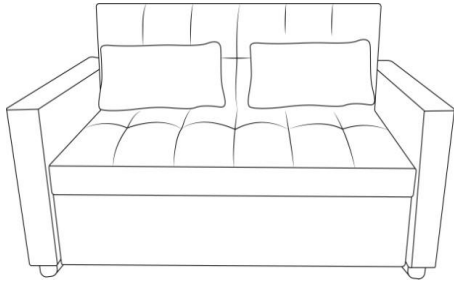

# Assembly Instructions

Thanks for purchasing this sofa bed. Before assembling, please carefully check all the parts included in the package. During transportation, there is a possibility that some small parts may have become loose inside the box. To ensure a smooth assembly process, we recommend that you thoroughly inspect all the parts before starting and make sure they are intact and nothing is missing.



Parts list					
A:		4PCS	B:		2PCS
C:		4PCS	D:		1PC
E:		2PCS			

## 1. OPEN CARTON CAREFULLY AND TAKE OUT ALL PARTS

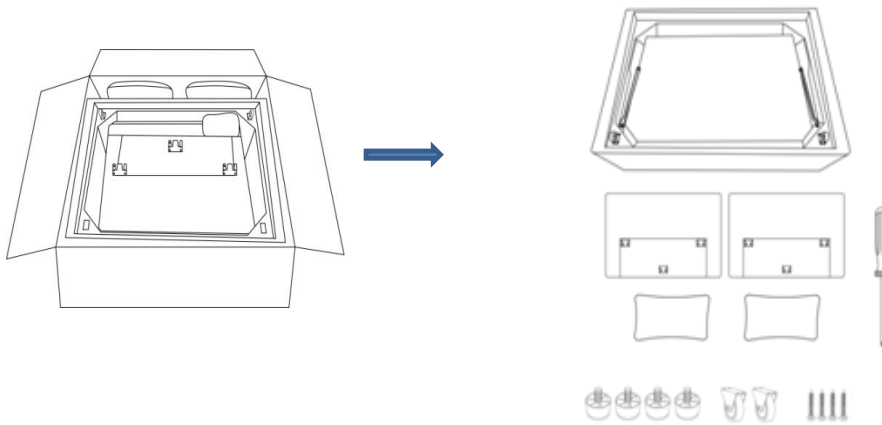

## 2. LEGS ASSEMBLY

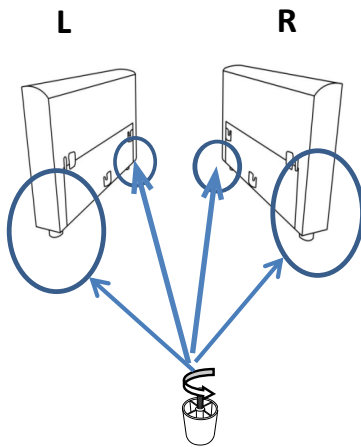

## 3. LEG & WHEEL ASSEMBLY

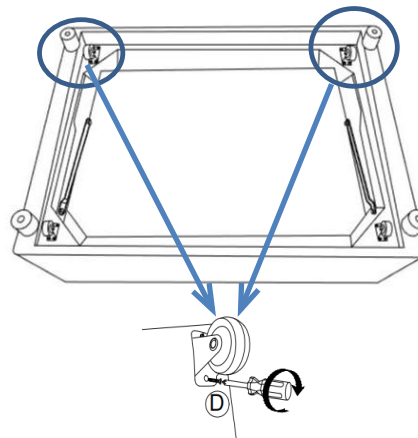

Lock with self tapping screws, pay attention to the direction of the wheels.

#### 4. ARM ASSEMBLY

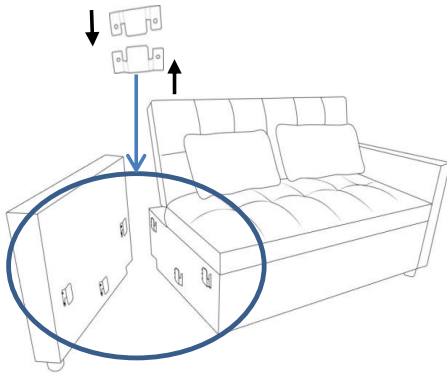

#### 5. ASSEMBLED SOFA BED

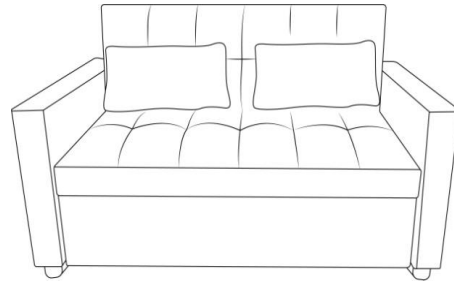

#### 6. PULL OUT SOFA BED

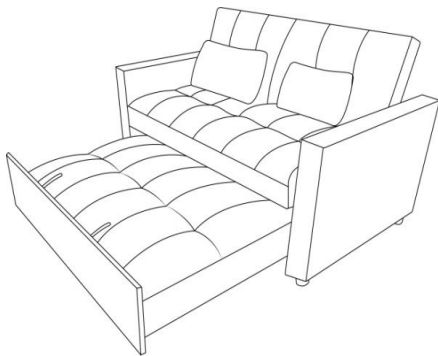

#### 7. BED POSITION

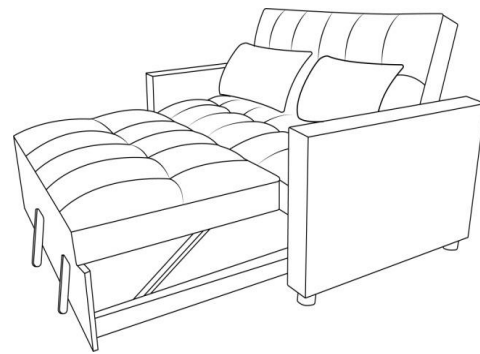

#### 8. BED POSITION



**Attention :**  
When you lift the backrest from the bottom up to 35 degrees and hear a click, it is in the first position. When you lift it further to 70 degrees, it is in the second position. If you continue to lift it to 90 degrees, it will be in the neutral position, allowing you to lean back.