

Dining Table



INSTRUCTION MANUAL

ASSEMBLY INSTRUCTIONS:

·Our clear, easy-to-follow, step-by-step instructions will guide you through the project from start to finish.

·Do not skip any steps.It is of utmost importance to assemble all of the parts according to the directions.

Item identification: For ease of identification,all parts are labeled to correspond to the step number in which the part is used.

IMPORTANT:

·Read the following instructions carefully before using the chair.

·Caution: Some components are heavy and contain sharp edges.

·Do not overtighten screws (Insert all screws before tightening them).

·Firmly secure all bolts, screws, and nuts before use.

·Please do not exceed the weight limitations of this item.

·Check and retighten all bolts, screws, and nuts every 90 days.

CARE & SAFETY:

·Always use on firm, level ground.

·Keep all children and pets away from the assembly area. Supervise them during assembly.

·Position the assembled product at least 6 feet (2 m) from obstructions (e.g., fences, walls, overhanging branches, or power lines).

·Do not use or store near open flames or flammable/combustible materials.

·If fire occurs, do not use water on burning polypropylene.







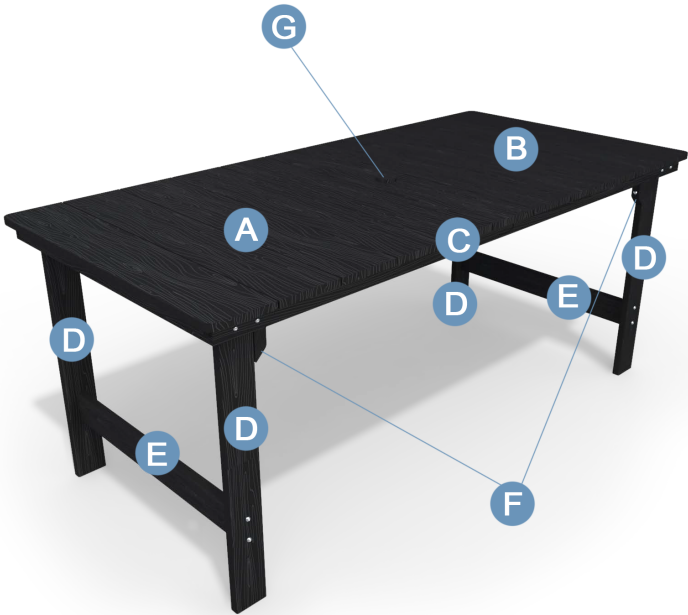
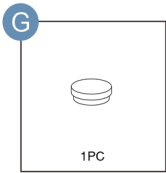
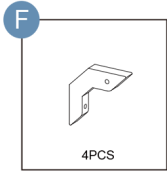
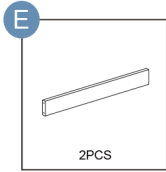
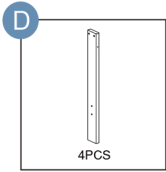
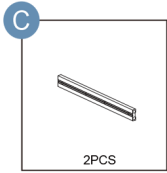
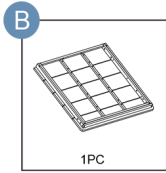
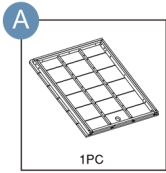

·Use caution when folding the chair to avoid pinching hands or fingers.

·Contact Customer Service for missing parts or assembly issues.

Parts List



Hardware List

- | | | |
|--|--|--|
| <p>1</p> <p>M6.3 x 60mm
Screw</p>  <p>12PCS</p> | <p>2</p> <p>M6 x 16mm
Bolt</p>  <p>8PCS</p> | <p>3</p> <p>M6 x 40mm
Bolt</p>  <p>4PCS</p> |
| <p>4</p> <p>M6 x 50mm
Bolt</p>  <p>2PCS</p> | <p>5</p> <p>M6 x 75mm
Bolt</p>  <p>8PCS</p> | <p>6</p> <p>M6 Washer</p>  <p>10PCS</p> |
| <p>7</p> <p>M6 Nut</p>  <p>10PCS</p> | <p>8</p> <p>NO.10 Spanner</p>  <p>1PC</p> | <p>9</p> <p>Allen key</p>  <p>1PC</p> |

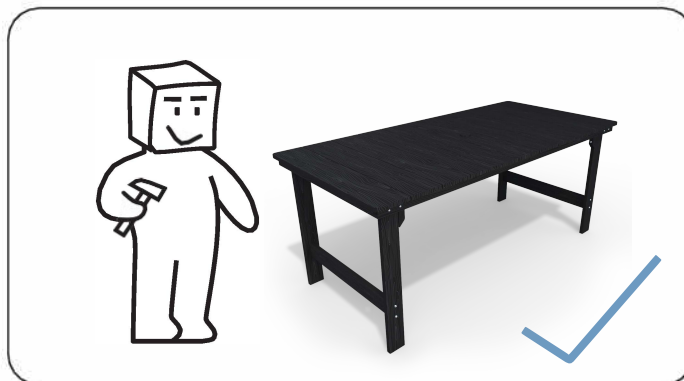
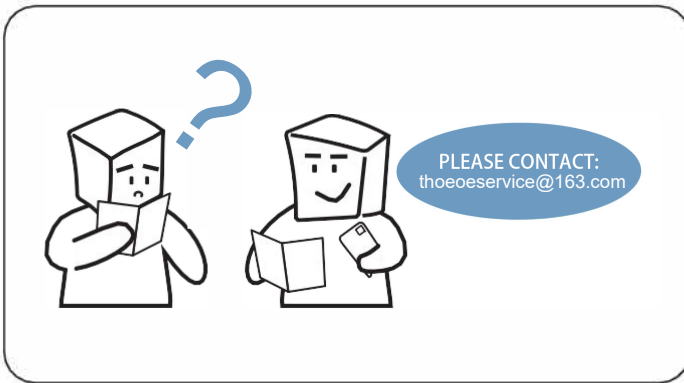

STEP 1

Secure part C to part A and part B, using hardware 2(M6*16mm Bolt).

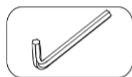
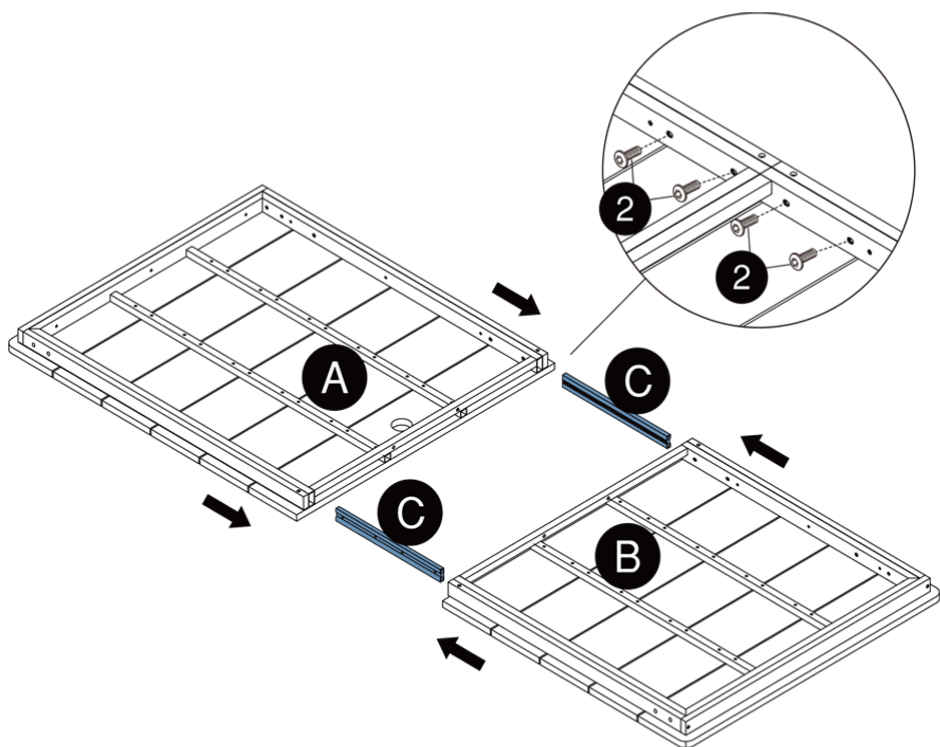

A x1

B x1

C x2

2 x8

STEP 2

Secure part A to part B, using hardware 4(M6*50mm Bolt), hardware 6(M6 Washer)and hardware 7(M6 Nut).

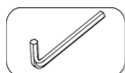
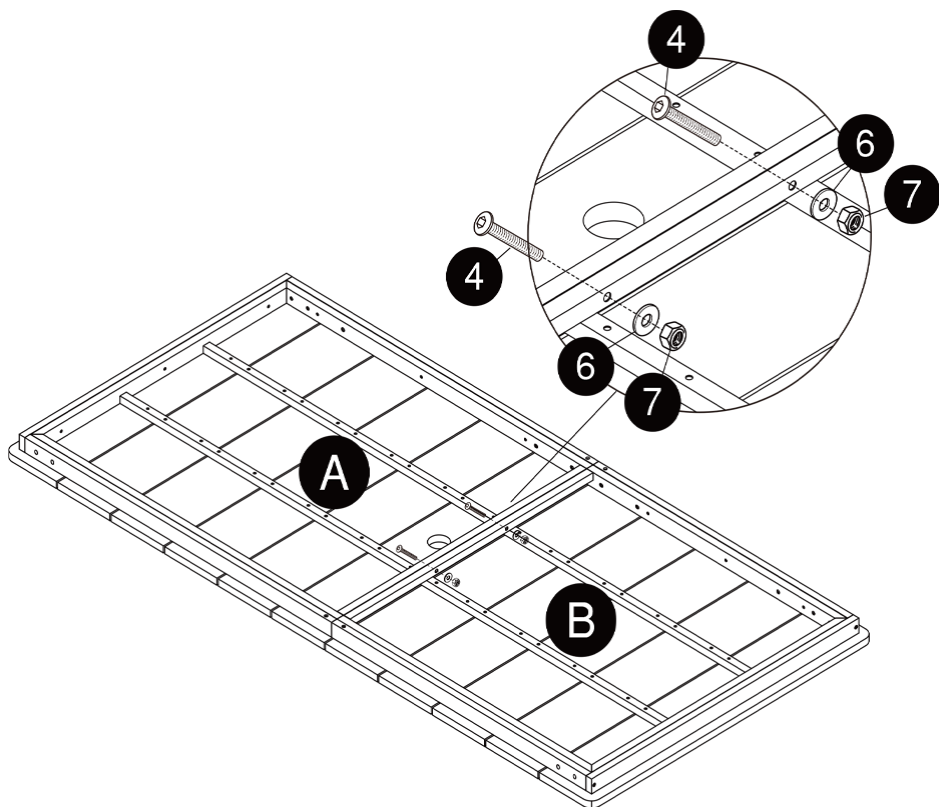

4 x2

6 x2

7 x2

STEP 3

Secure part D to the finished part in step 2, using hardware 5 (M6*75mm Bolt), hardware 6 (M6 Washer) and hardware 7 (M6 Nut).

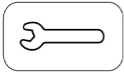
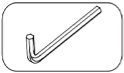
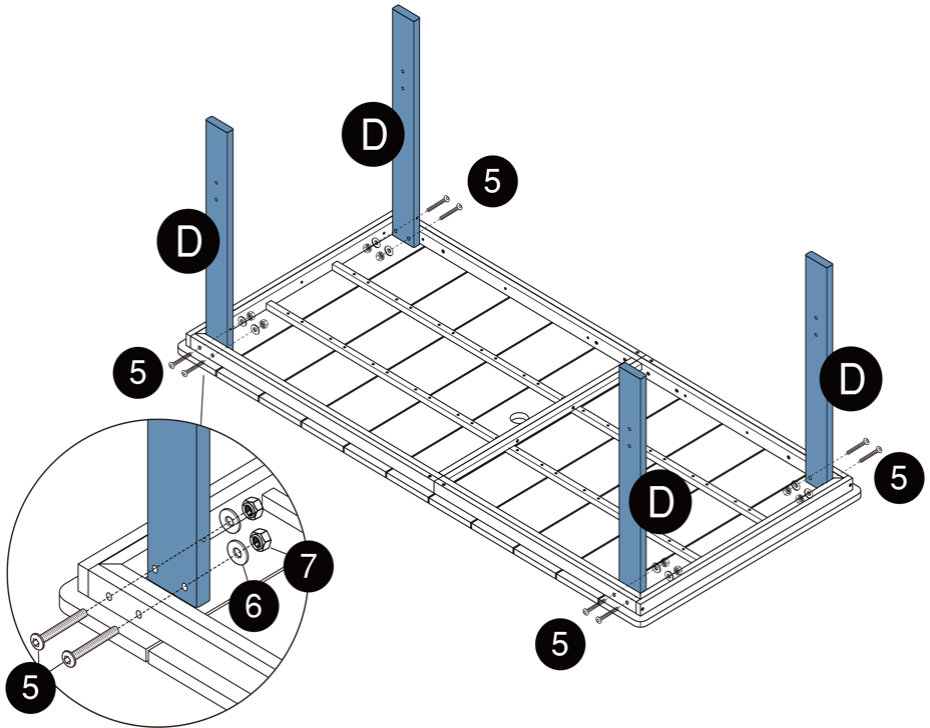

5 x8

6 x8

7 x8

STEP 4

Secure part E to part D, using hardware 1 (M6.3*60mm Screw).

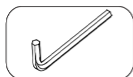
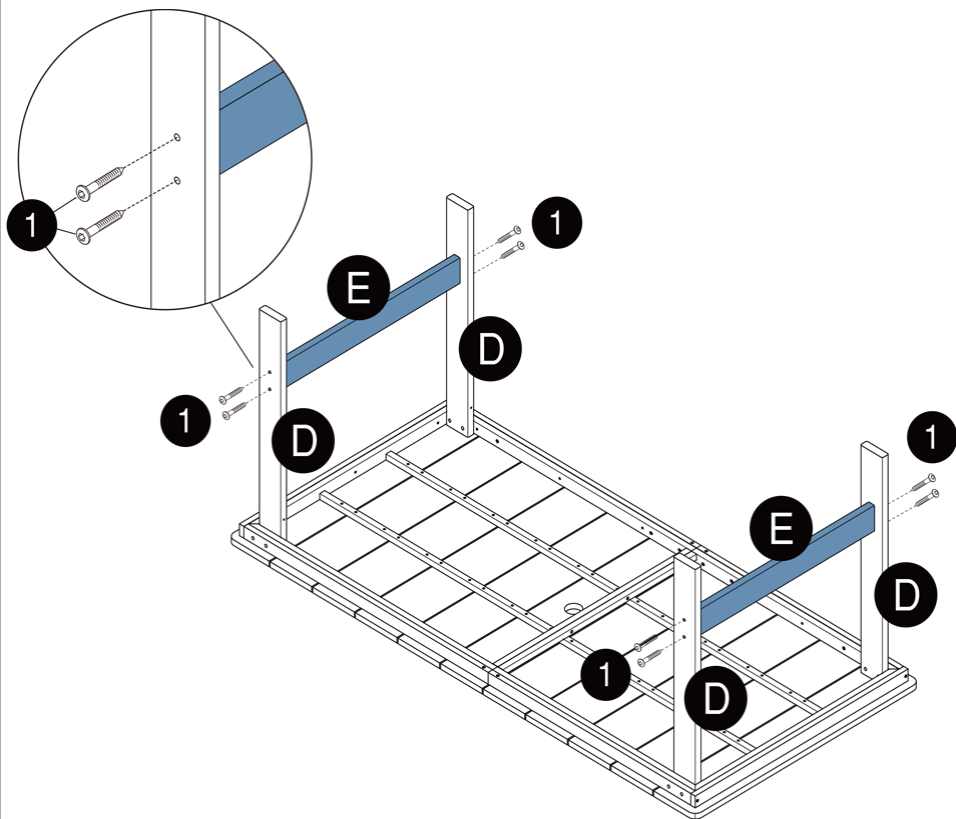

E x2

1 x8

STEP 5

Secure part F to part A and part B, using hardware 3(M6*40mm Bolt).
Secure part F to part D, using hardware 1(M6.3*60mm Screw).

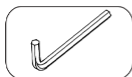
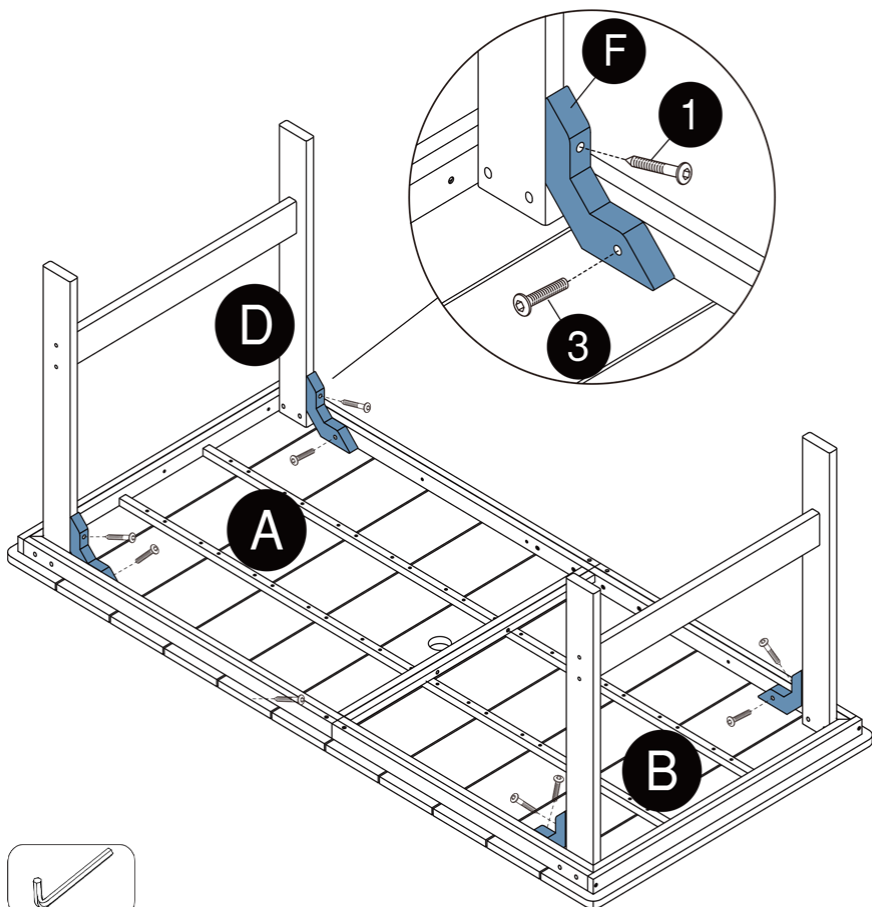

F x4

3 x4

1 x4

STEP 6

Secure part G to the finished part in step 5.

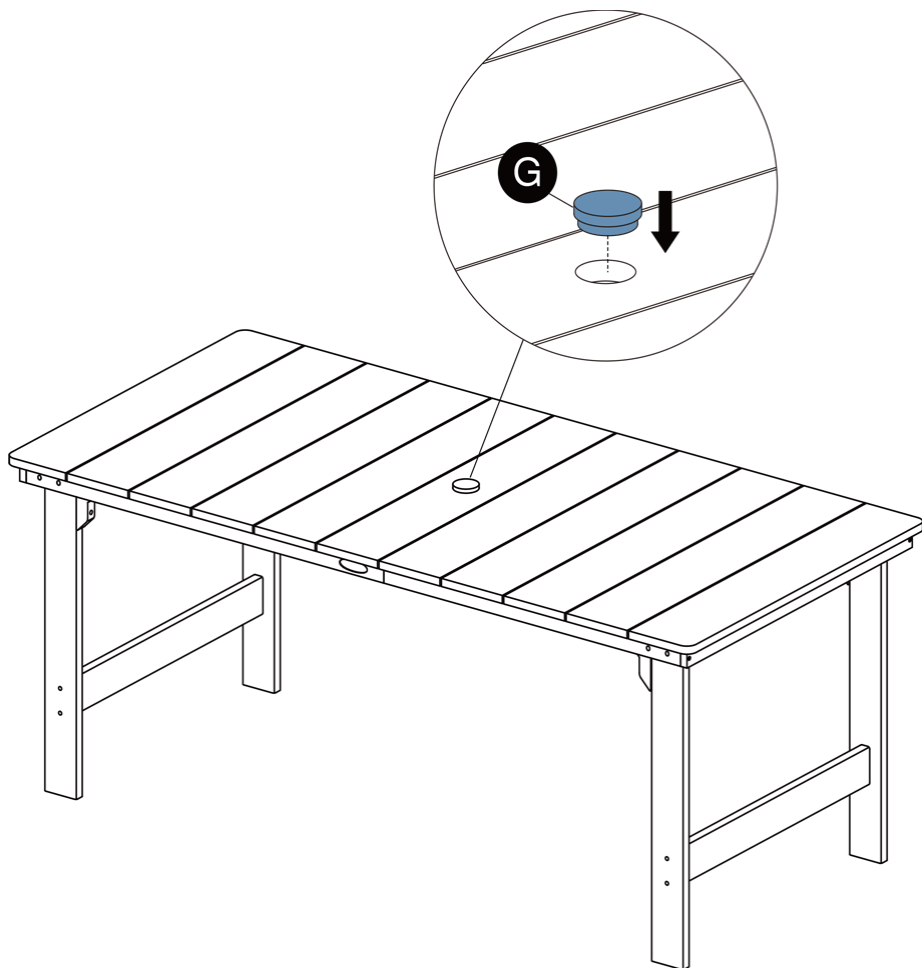

G x1

INSTALLATION COMPLETED



**PAY ATTENTION
DO NOT EXCEED THE MAXIMUM
LOAD OF 380LBS**

THANK YOU FOR SHOPPING WITH US!

If you have any questions, or need assistance with use, parts, or customer service, please contact:

thoeoeservice@163.com

To help us identify your order, please include your 17-digit Amazon Order ID. Our professional team will be there to assist you.

Customer Service Team

WARRANTY

Thoeoe we provide a basic warranty against defects in materials and workmanship for 2 years from the date of purchase for the product you have purchased. During this period, we will repair or replace defective parts at our sole discretion.

This warranty does not apply to units that have been improperly installed, mishandled, abused, damaged due to user error, or repaired or altered by unauthorized repair companies.

This limited 2-year basic warranty does not cover consequential or incidental damages. The warranty grants specific legal rights that may differ based on state laws, and customers may retain additional rights under applicable legislation.