









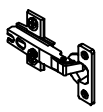

<p>A 6*32</p>  <p>16PCS</p>	<p>B 8*30</p>  <p>16PCS</p>	<p>C</p>  <p>4PCS</p>	<p>D</p>  <p>4PCS</p>	<p>E</p>  <p>5 PCS</p>  <p>10PCS 3.5 *16</p>	<p>F 3.5 *14</p>  <p>72 PCS</p>	<p>H 128mm</p>  <p>2PCS</p>  <p>4*18 4PCS</p>	<p>J</p>  <p>2PCS</p>
<p>LED</p>  <p>1PCS</p>	<p>K 40*80</p>  <p>4 PCS</p>						

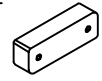
1

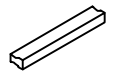

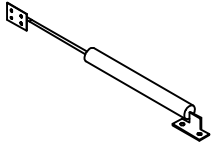
F*16 K*2

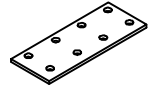
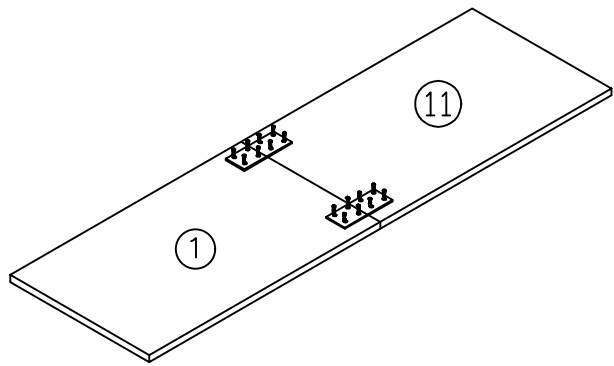
2

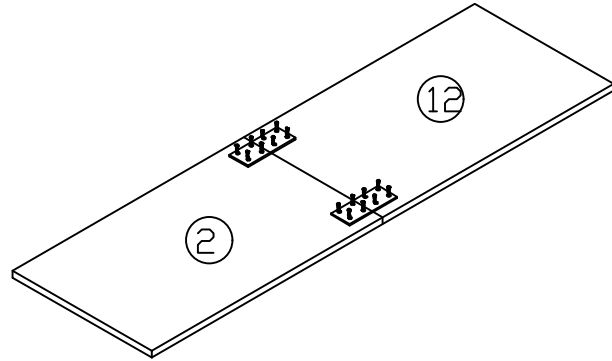

F*16 K*2

3

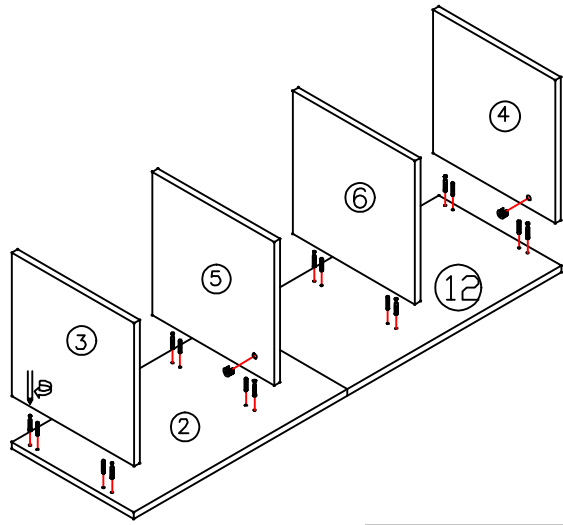

A*8 B*8

4

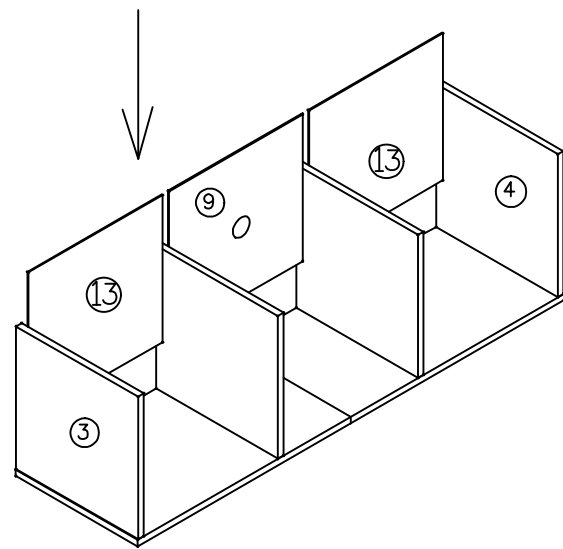

5

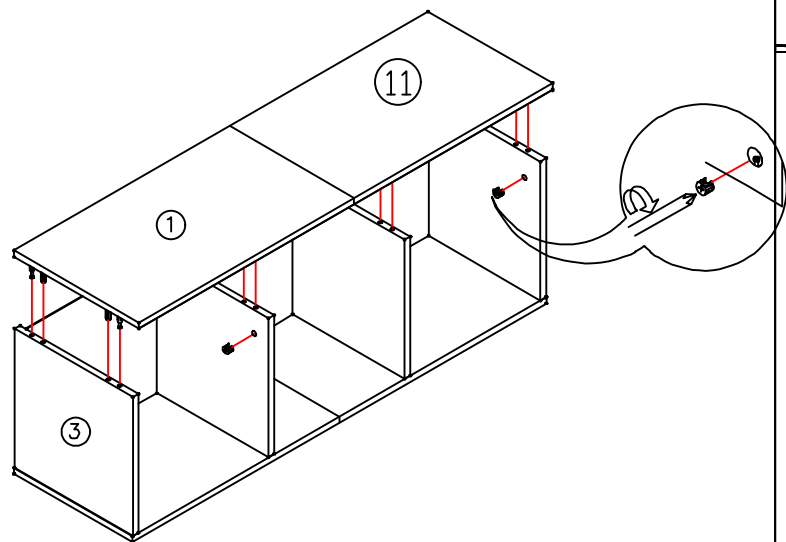

A*8 B*8

6

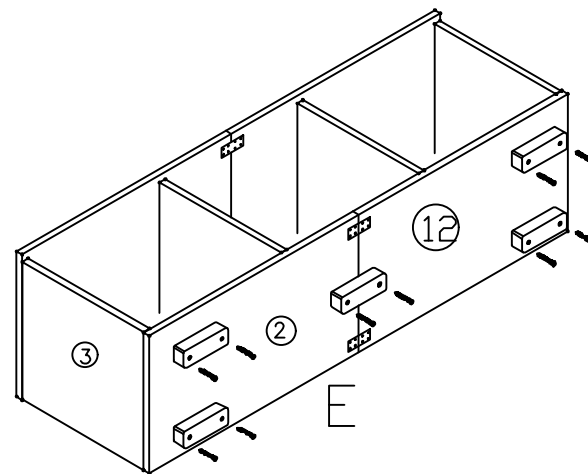

E*5

7

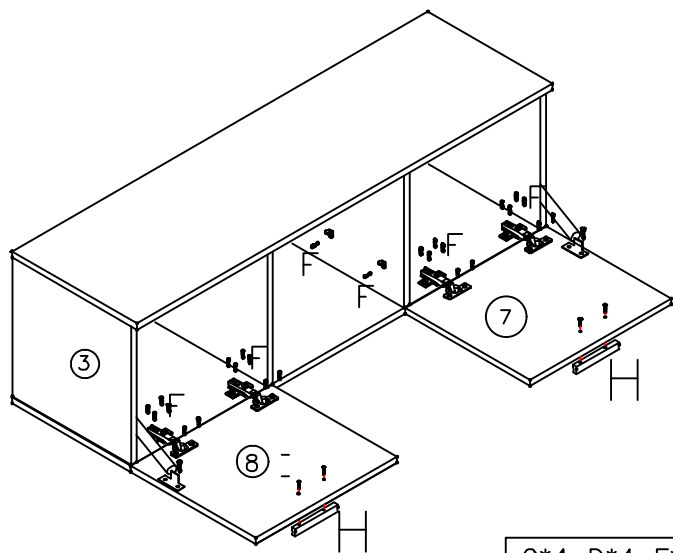

C*4 D*4 F*40 H*2 J*2

8

