

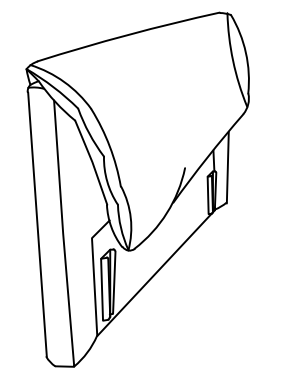

Accessories list

 Right armrest(1)	 Left armrest(1)	 Seat frame(1)
 Backrest(1)	 Back cushion(2)	 M5x95x35wrench(1)
 Sofa foot(4)	 8x60 screw(4)	 16mm gasket(4)
 38mm Woolenmat(4)		

STEP 1:
Insert the armrest into the sofa seat frame

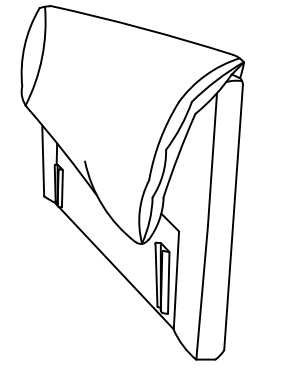
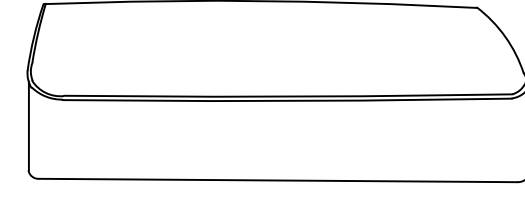
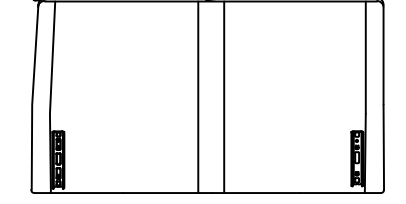
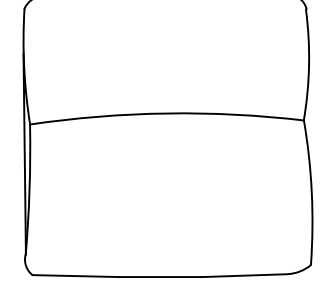

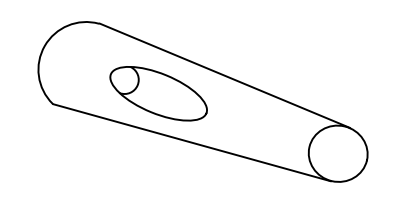
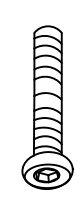
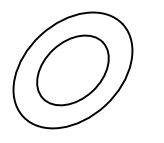
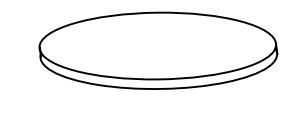
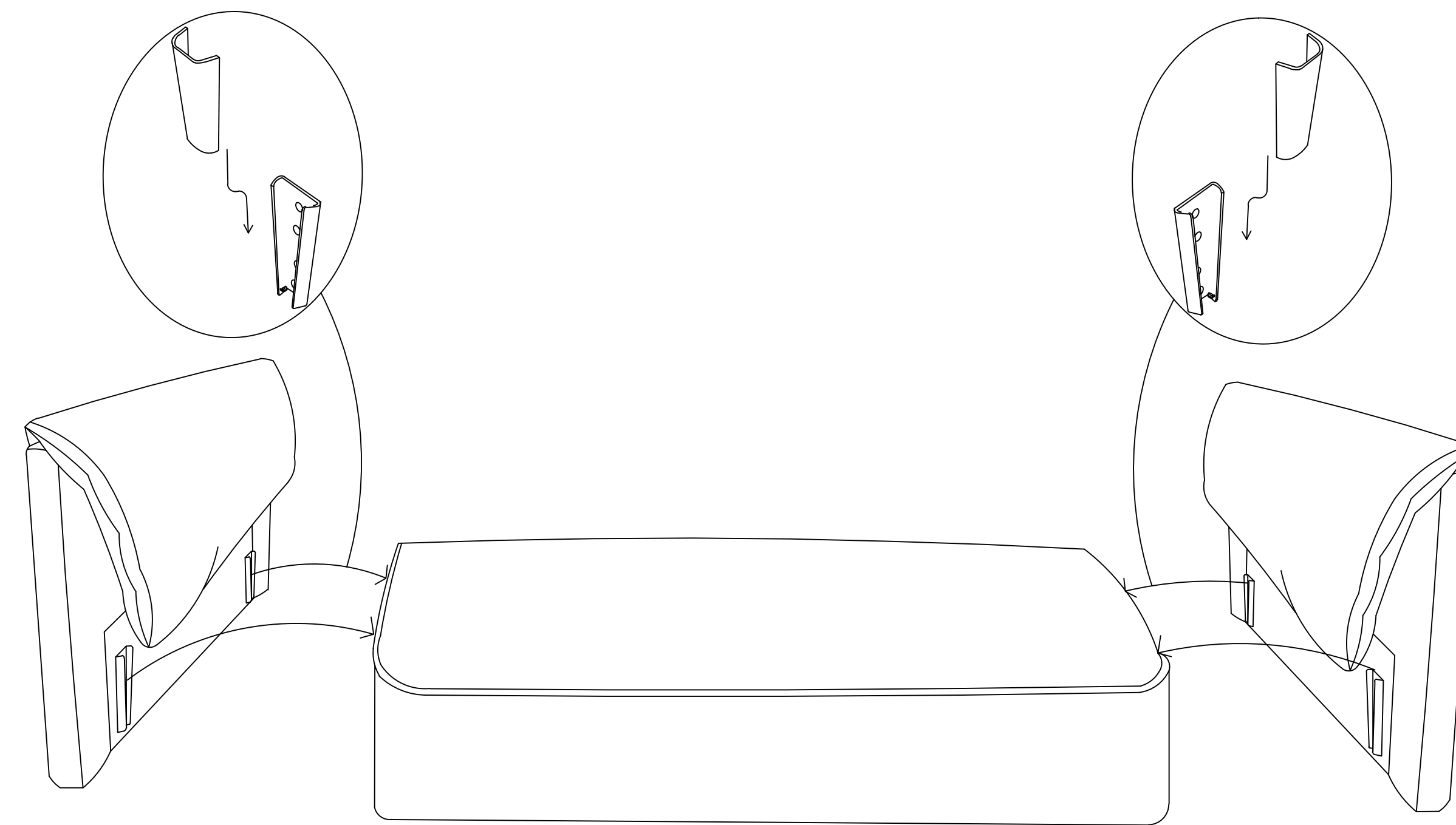
STEP 2:
Insert the backrest into the sofa base

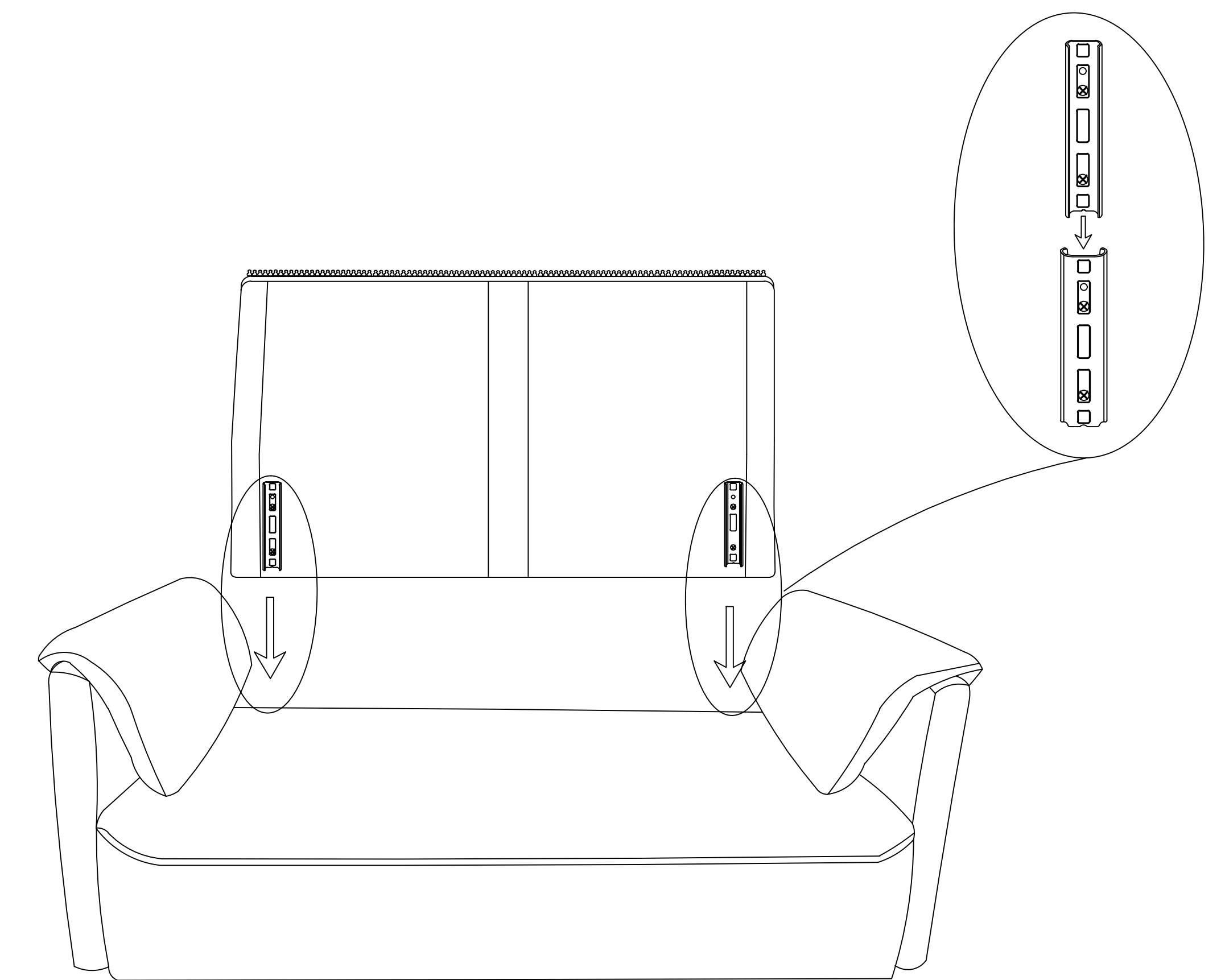

STEP 3:
Cut the compression bag

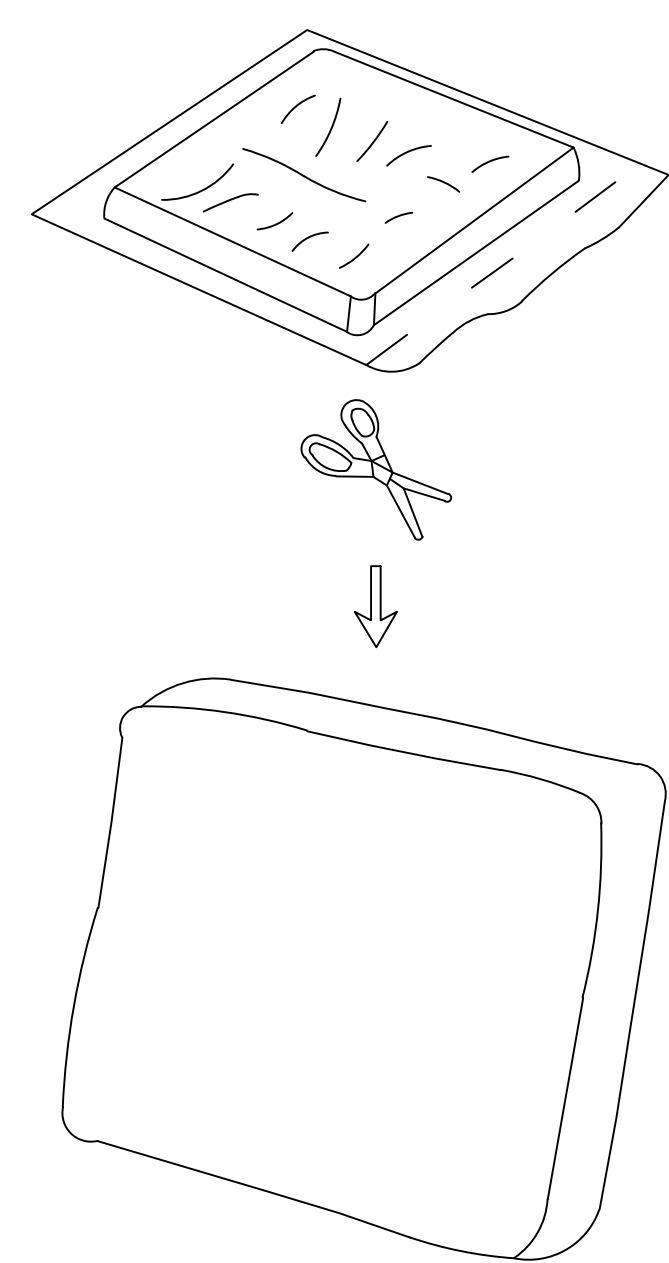

Back cushion(2)

STEP 4:
Tie the zipper between the backrest and the back cushion

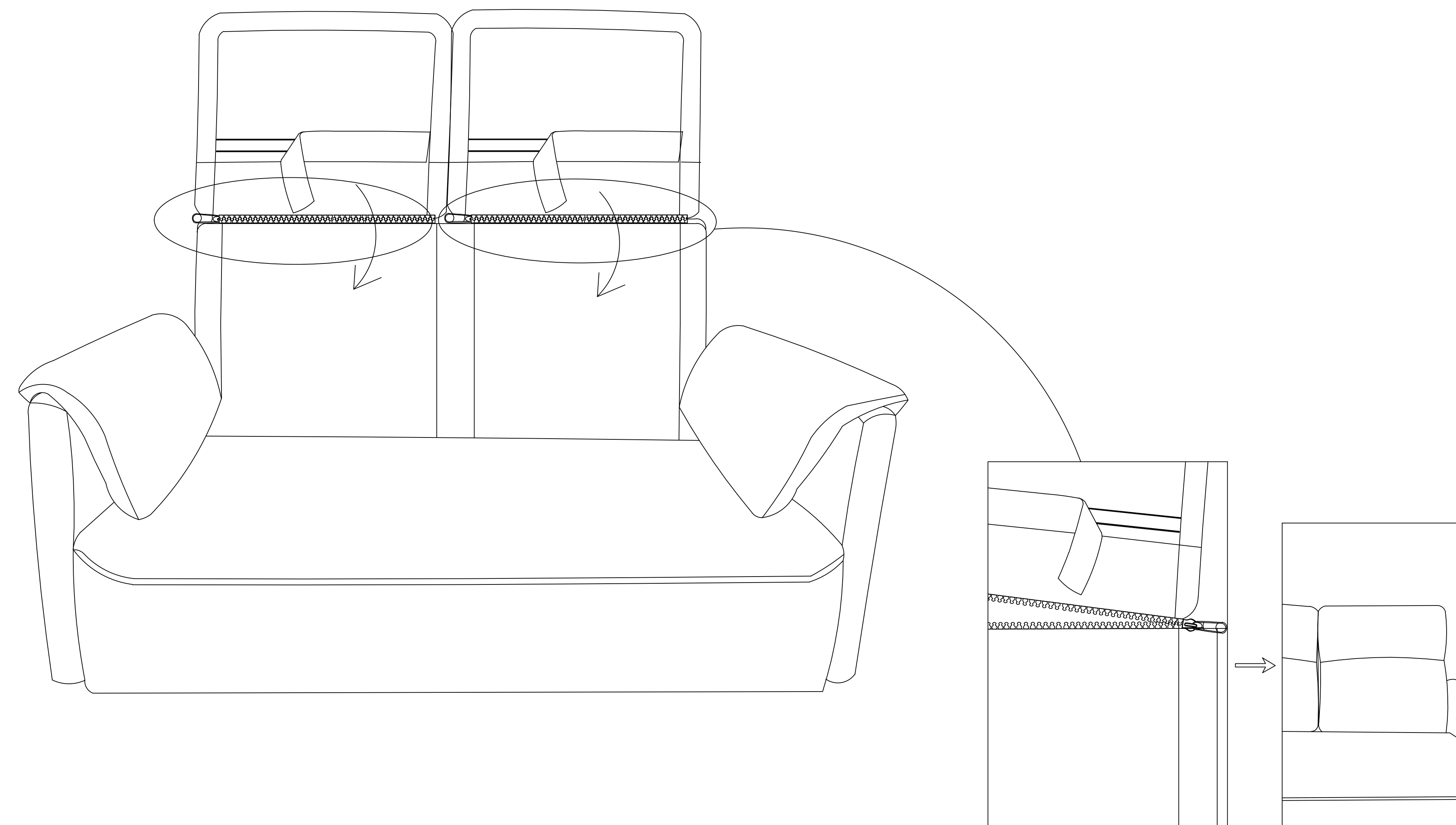

STEP 5:
Turn the sofa side up and install the sofa feet

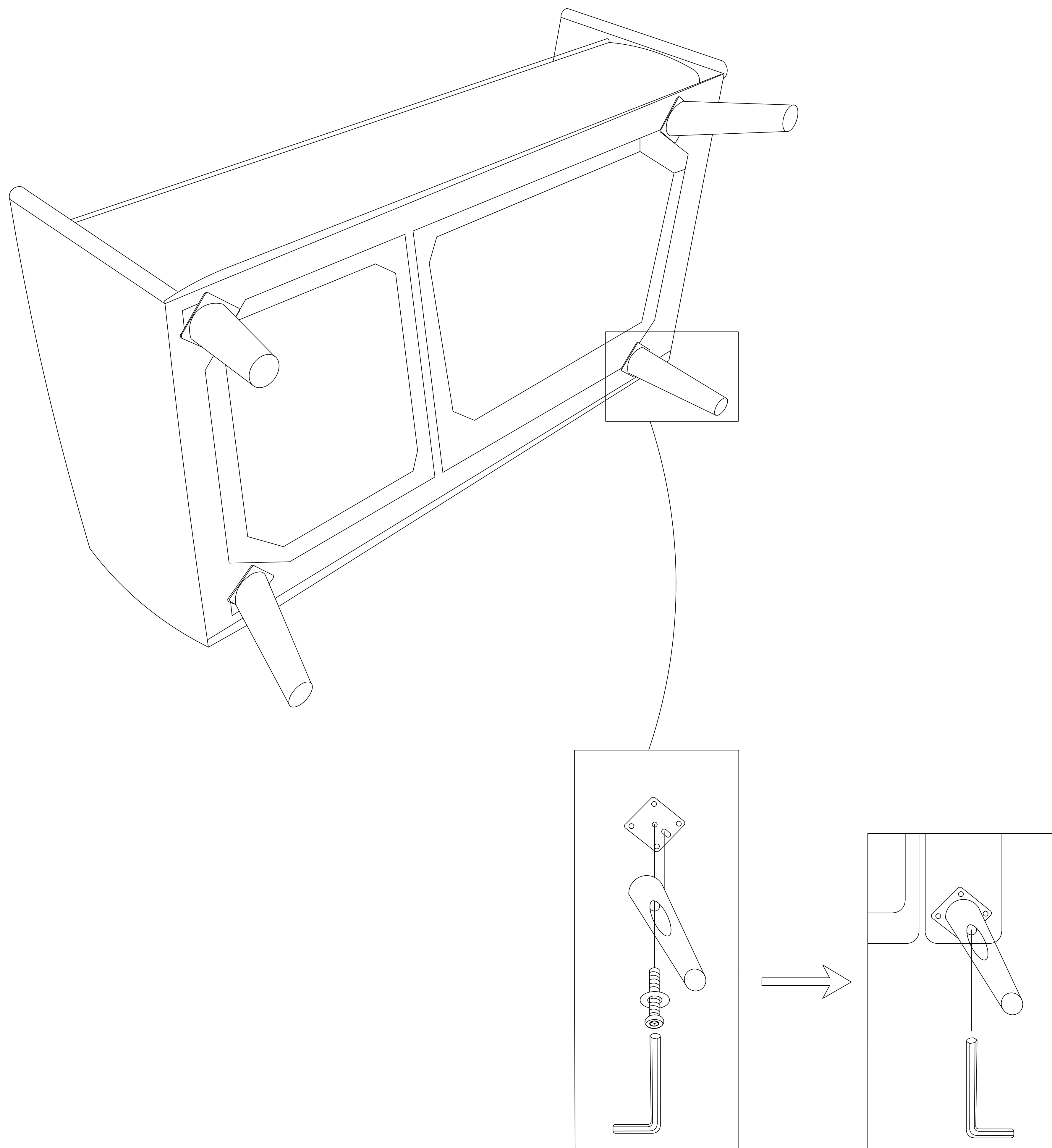

STEP 6:
Assembly completed

