

PET PATIO BED

W170390116

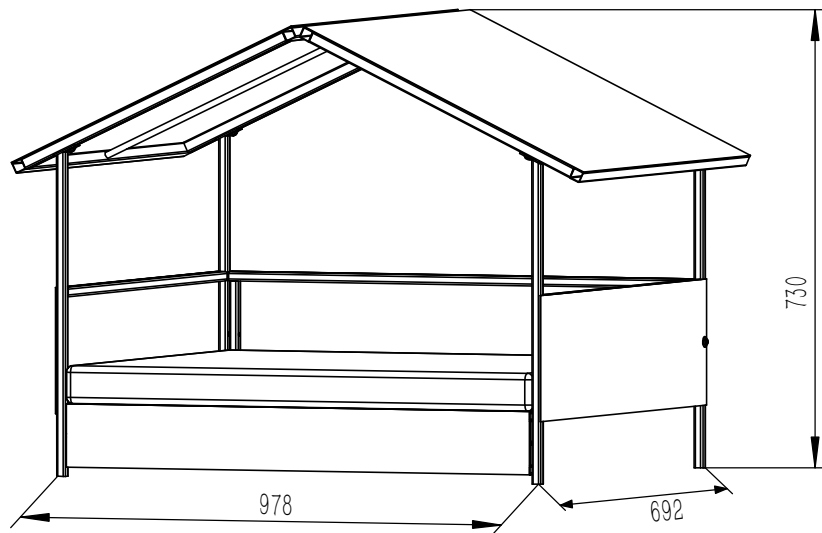

Notice:

1. 50% Tighten before fixing all screws, Allen wrench is recommended instead of an electric drill.
2. Place the item on a flat ground to adjust and make sure it remains stable.
3. Tighten up all screws with tools gradually.
4. If the screws are not aligned with holes during assembly, please loosen all the other screws to 50% and continue the assembly process.
5. If the item is not stable, please loosen all the screws, adjust it on a flat ground and tighten up all screws again.
6. Note : If one or some screws are fully tightened during assembly, chances are the others will not be aligned with holes. In addition, all the holes are designed to be relatively larger to provide more space for the adjustment of the screws.

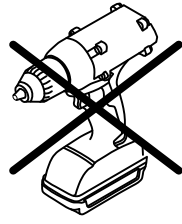

A x 14



M6mm

B x 4



M6*15mm

C x 10



M6*35mm

D x 1

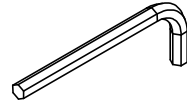

4mm

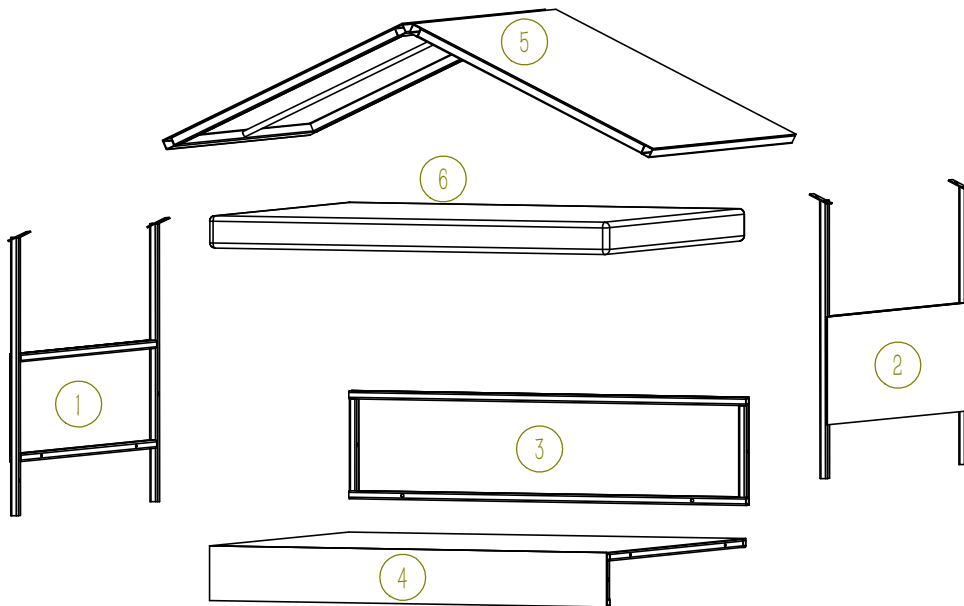

Box: 1/1

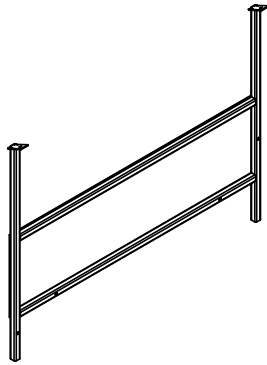

① x1

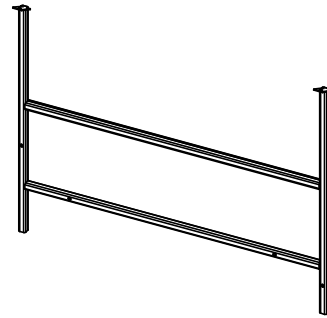

② x1



③ x1

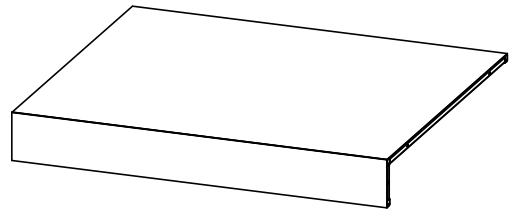

④ x1

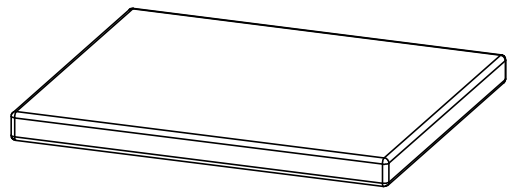



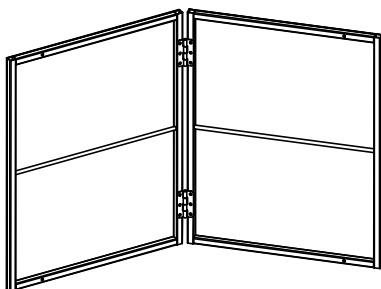

⑥ x1

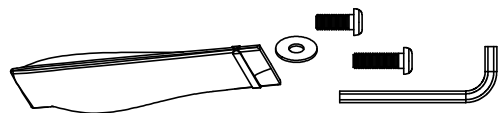

⑤ x1



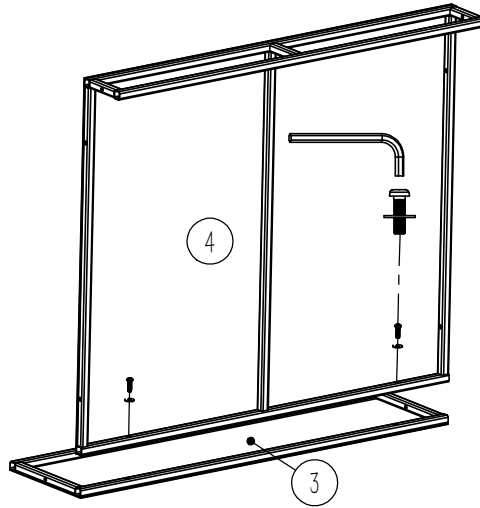

1

A x 2  M6	C x 2  M6x35	D x 1  4mm		
--	---	---	--	---





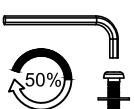

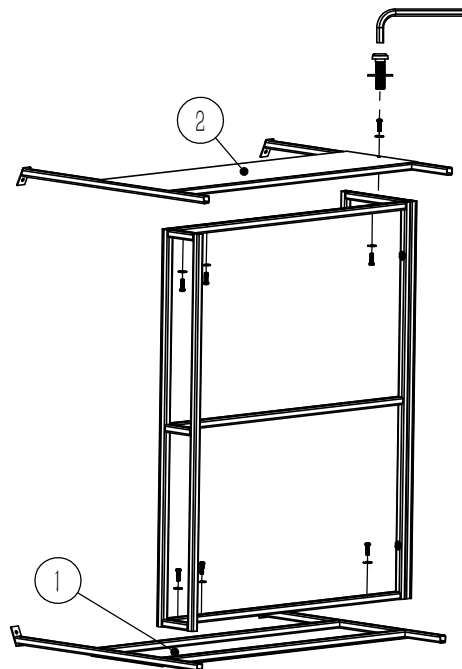
2

A x 7  M6	C x 7  M6x35	D x 1  4mm		
--	---	---	--	---



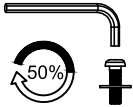

3

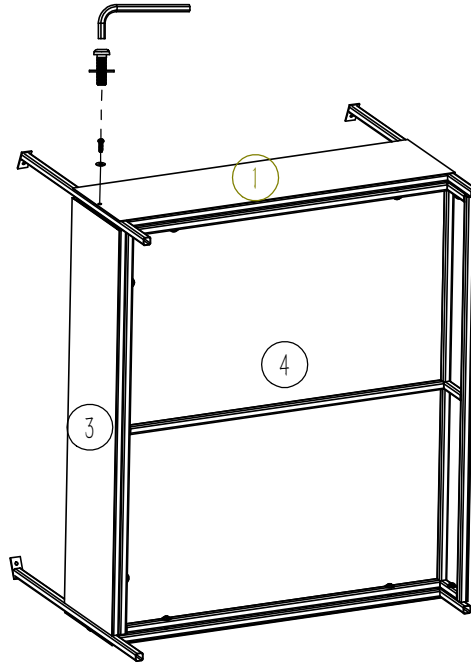
A x 1  M6	C x 1  M6x35	D x 1  4mm		 
--	---	---	--	--



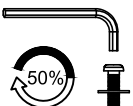

4

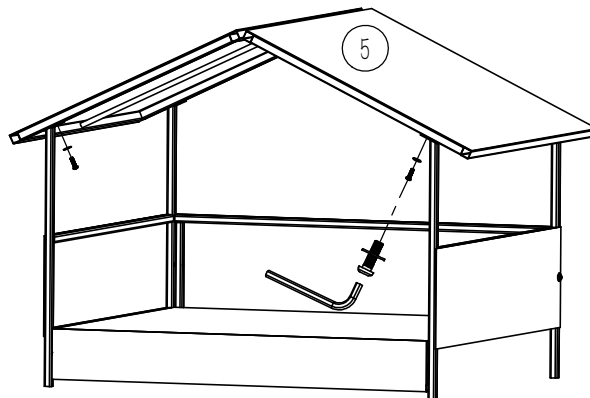
A x 2  M6	B x 2  M6x15	D x 1  4mm		 
--	---	---	--	--



5

A x 2  M6	B x 2  M6x35	D x 1  4mm	 50%
--	---	---	--

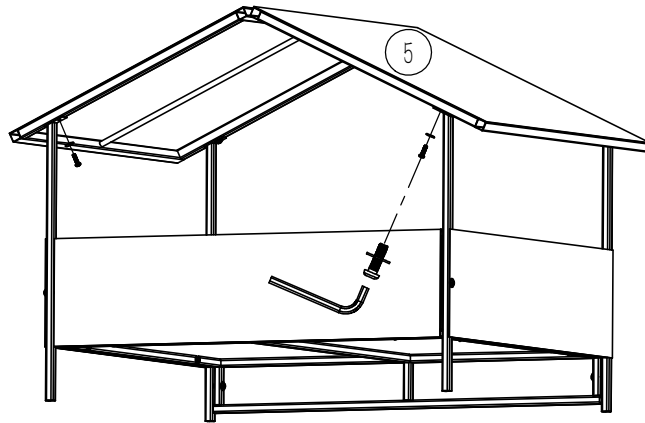

6

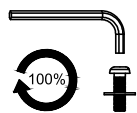
 100%

