









Assembly Instructions

Caution : You must read this before you proceed

Care & Maintenance



-  ● Not for commercial use. For residential use only.
 -  ● Furniture may scratch floors. We recommend using furniture pads to protect your floors.
 -  ● Do not put hot items directly on furniture surface.
 -  ● Do not clean furniture with harsh cleansers or polish.
 -  ● Do not place furniture under direct sunlight.
 -  ● Do not place furniture near heating or cooling vents.
 -  ● Do not write on furniture without a padded barrier to protect the surface.
 -  ● Do not place furniture outside . For indoor use only.
 -  ● Stains may be removed with mild soap solution and damp cloth.
 -  ● Children should not climb or jump on the furniture.
-
-  ● Dust and pick-up spills using a clean, non-colored, lint-free cloth.

Please look in carton for hardware packs and legs.
Sets often ship in multiple boxes and may arrive a day or two apart.

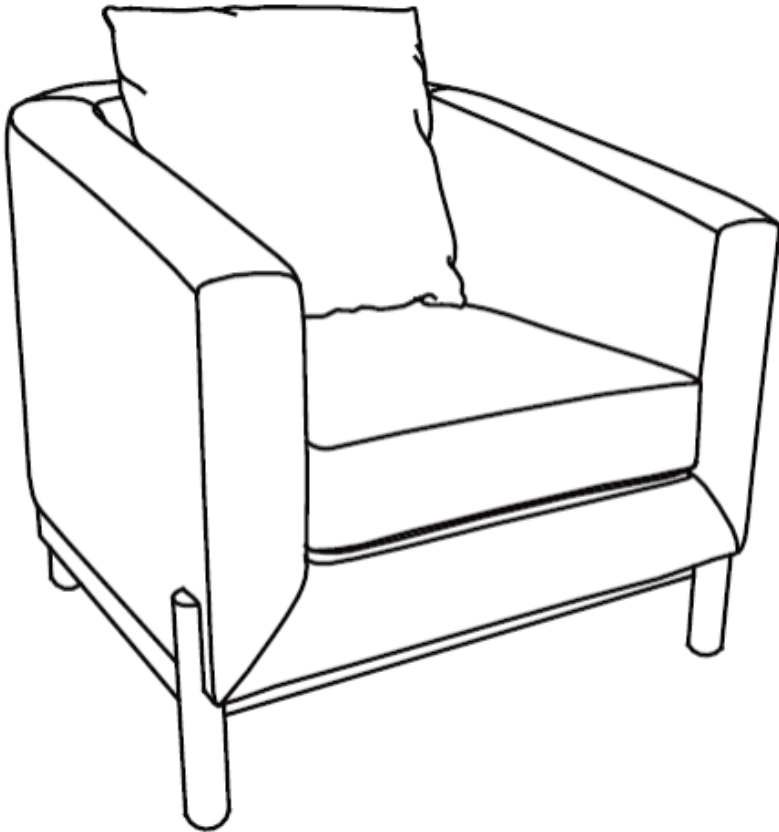

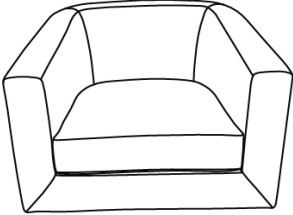
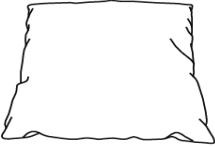
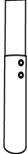

Club Chair



Parts List

Label	Picture	Description	QTY
A		Chair	1
B		Pillow	1
C		Front Left Leg	1
D		Front Right Leg	1
E		Hind Leg	2

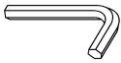
Hardware

Label	Picture	Description	QTY
①		Bolt (M8*80 MM)	5
②		Washer	9
③		Bolt (M8*60 MM)	5
④		Allen Wrench	1
⑤		Spring Washer	9

Assembly Preparation

Before Beginning Assembly:

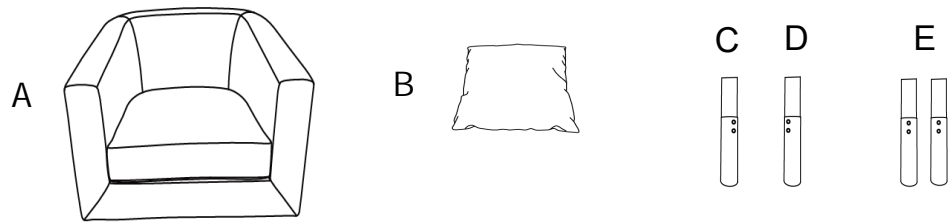

- Read instructions, cover to cover-



- Have 2 adults on hand for assembly-



- Do not assemble on flooring or carpet-



- Assemble on a clean non-marring surface (packing foam)-



- Save all packaging until finished-

Assembly Steps

Overview

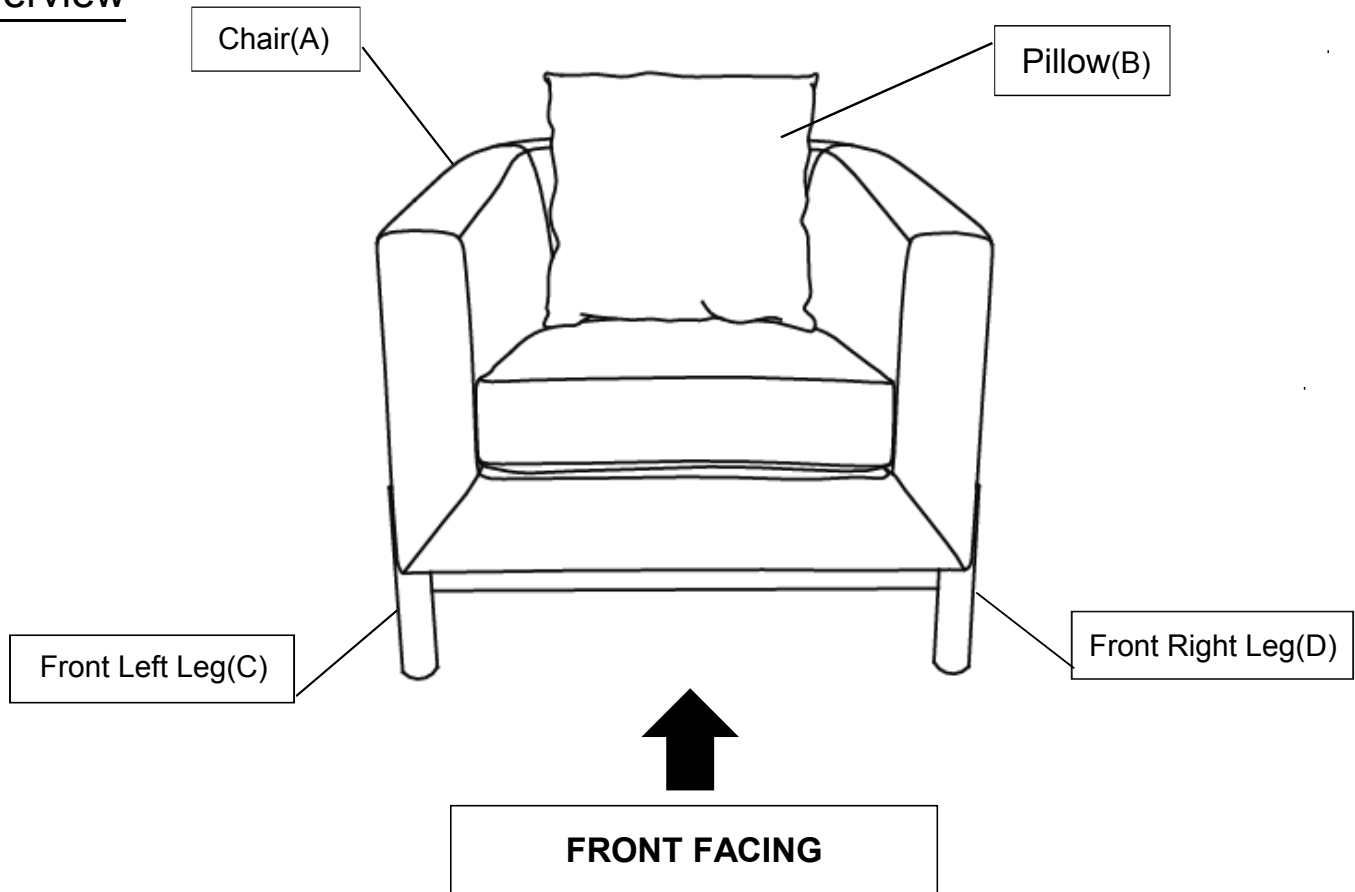

This Chair has multiple parts and may require up to 30 minutes to assemble. To give you an overview of the Chair, the above picture is to help you put the various parts into perspective. Please read through the instructions below to familiarise yourself with the parts and steps before assembly.

Note: It is recommended that you have an adult partner to assist during the entire assembly process.

Step 1

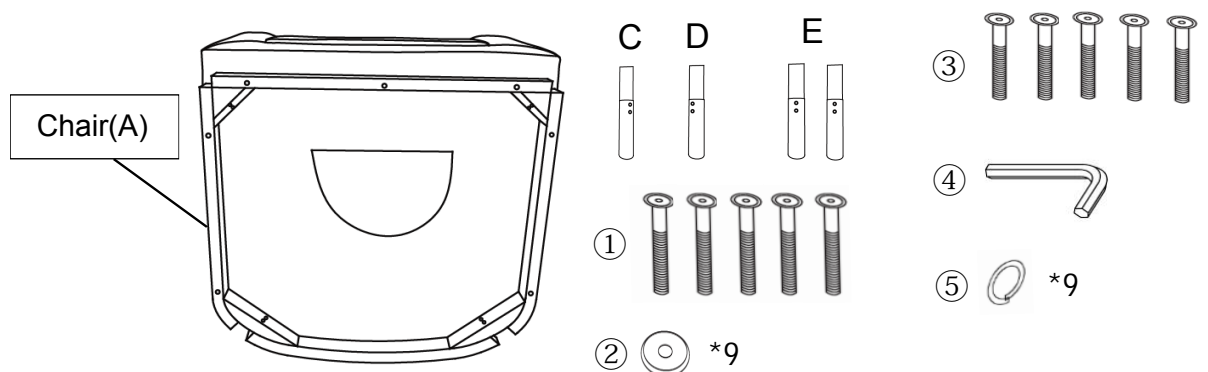

Position the Chair(A) on its back, as shown.

Do not place on surface that can scratch or damage the upholstery.

Unzip to open and remove the 4 wooden legs.

Close the pouch before assembling.

Step 2

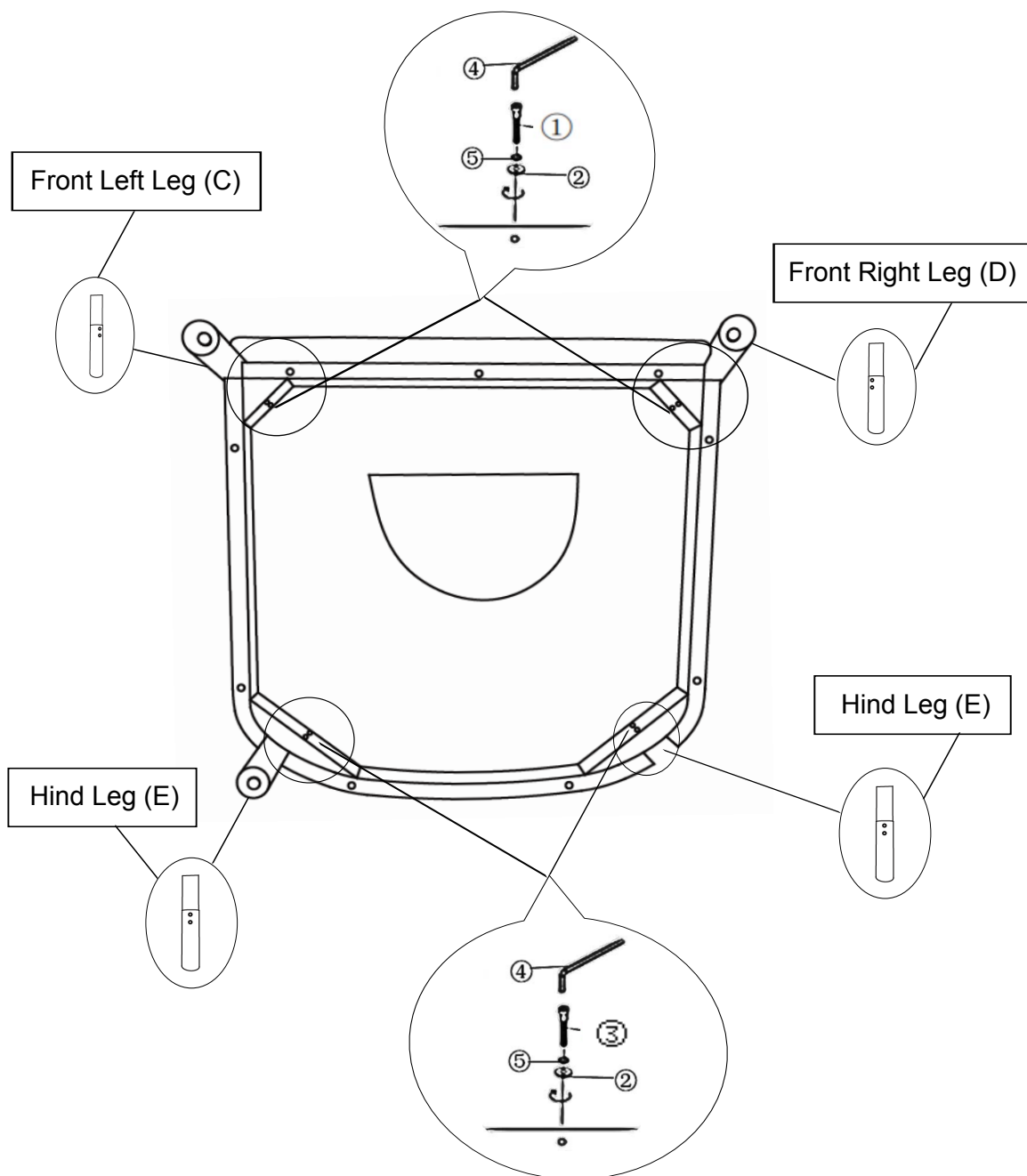

Tilt and lay the Chair on its Backrest onto a flat surface.

Install the Leg(E) to rear side using Bolts()(**the shorter one**), Spring Washers(), and Washers () with the Allen Wrench() as pictured above.

Install the Front Left Leg(C) to front side using Bolts()(**the longer one**), Spring Washers(), and Washers() with the Allen Wrench() as pictured above.

Install the Front Right Leg(D) to front side using Bolts()(**the longer one**), Spring Washers(), and Washers() with the Allen Wrench() as pictured above.

Tighten the Bolts fully in a sequential manner.

DO NOT fully tighten a Bolt in one go and then move on to the next.

Rather, In a sequential manner, gradually tighten each Bolt little by little until all Bolts are evenly secured.

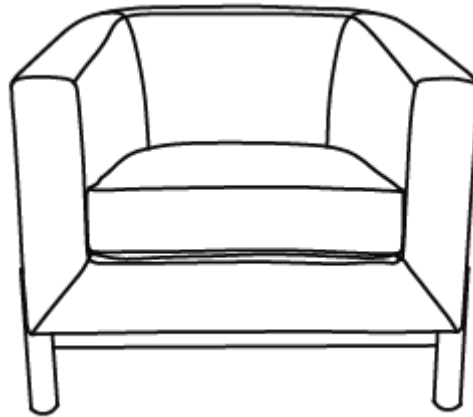

Step 3

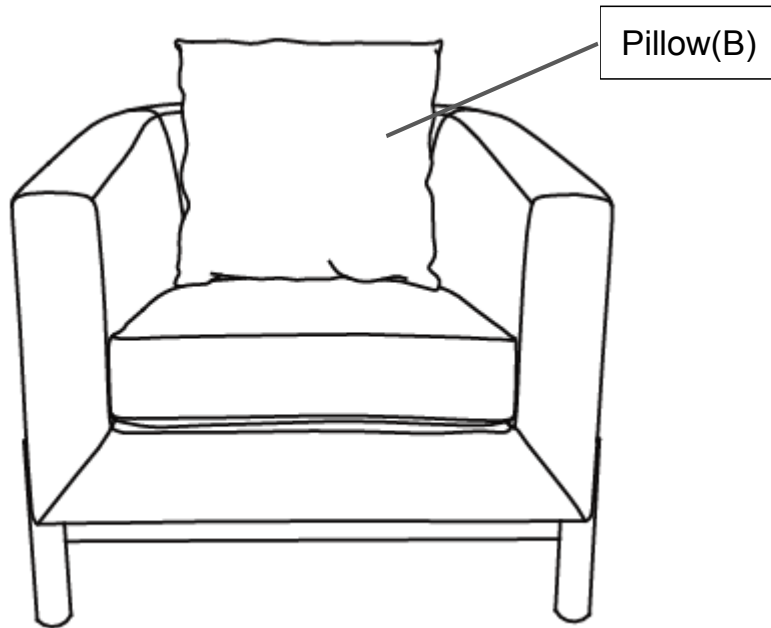

Place the Pillow(B) onto the Chair.
Your Chair is ready for use.
This Chair can only be used on a flat, level surface.