

# ASSEMBLY INSTRUCTIONS

Thank you for purchasing this quality product. Be sure to check all packing material carefully for small parts, which may have come loose inside the carton during shipment. Identify and count all parts and compare with the **HARDWARE LIST** below.













## HARDWARE/PARTS LOCATION







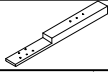
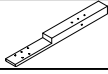

### QUEEN UPH HEADBOARD

> Step 3,4 & 5 hardware > Inside red pack with red tape > Placed next to the leg box  
> Headboard leg & stretcher > Inside labeled inner carton > Placed at below headboard

### QUEEN STORAGE FOOTBOARD

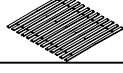
> Bun foot & support leg for footboard > Inside labeled inner carton > Placed above the slat  
> Support leg for slat > Inside labeled inner carton > Placed at side footboard  
> Step 2 & 7 hardware > Inside red pack with red tape > Attached to the support leg box

NO.	HARDWARE LIST		Q'TY
A		Ø5/16"X16X2mm Flat washer	12
B		Ø5/16"X12X2mm Spring washer	12
C		Ø5/16"X44mm Bolt	12
D		4mm Allen wrench	1
E		Ø5/16"X4-1/2" Bolt	8
F		Ø5/16" Half Moon Washer	8
G		Ø5/16" x 12mm Hex Nut	8
H		12mm Wrench	1
I		#8x1" Screw	26
J		Ø1/4"X38mm Bolt	6
K		Ø1/4"X16X2mm Flat washer	6
L		Ø1/4"X10X2mm Spring washer	6

NO.	PARTS LIST		Q'TY
1		Headboard	1
2		Headboard leg (left)	1
3		Headboard leg (right)	1
4		Bottom stretcher	1
5		Side rails	2
6		Storage footboard	1
7		Slat roll	13
8		Support leg for slat	6
9		Bun Foot	2
10		Support leg for footboard (143*32*32mm)	3

Do not fully tighten all screws and bolts until the entire item is completely assembled.

# ASSEMBLY INSTRUCTIONS

Thank you for purchasing this quality product. Be sure to check all packing material carefully for small parts, which may have come loose inside the carton during shipment. Identify and count all parts and compare with the **HARDWARE LIST** below.

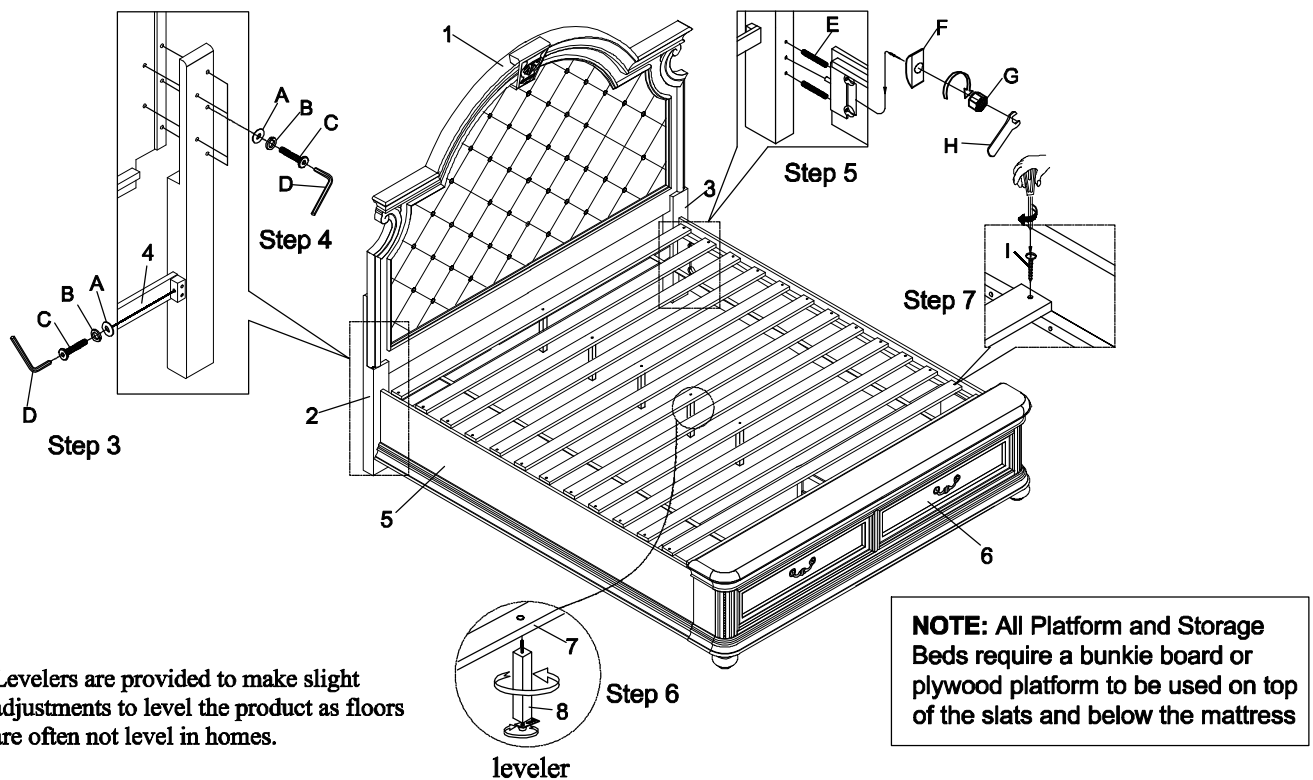
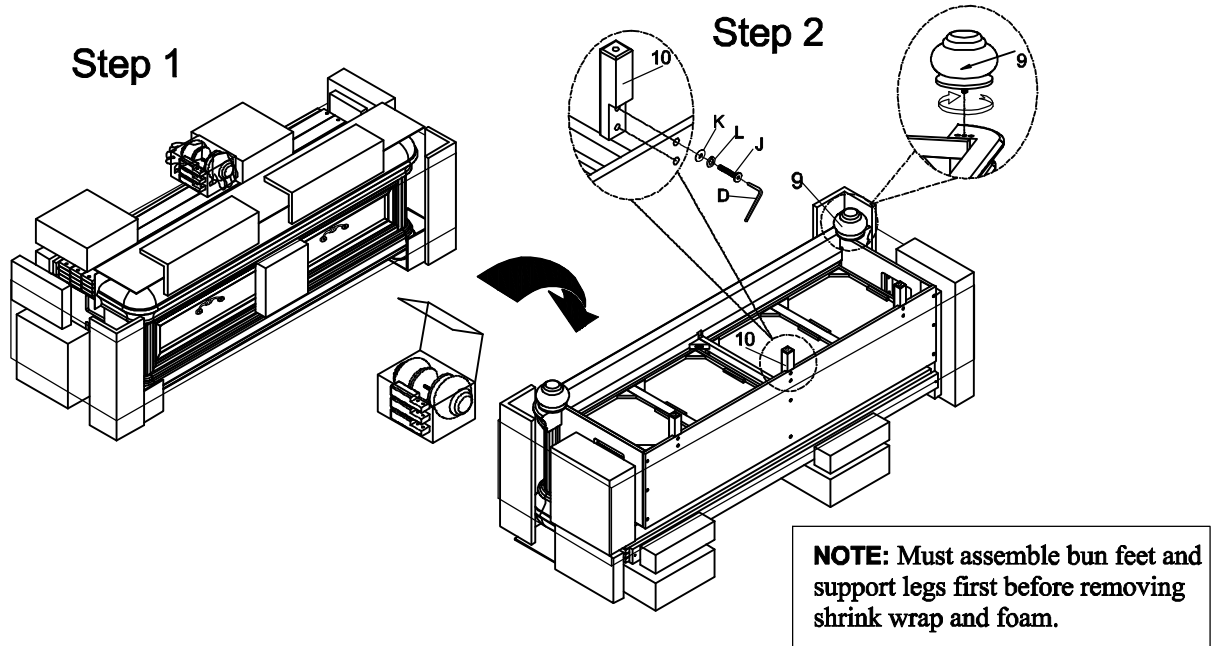

Do not fully tighten all screws and bolts until the entire item is completely assembled.