110/140cm

Round Wicker Table

Assembly Instructions

Product size:
Dia110*H75cm
Dia140*H75cm



IMPORTANT, RETAIN FOR FUTURE REFERENCE
READ CAREFULLY

110/140cm Round Wicker Table Assembly Instructions

Before you start



Warnings

IMPORTANT, RETAIN FOR FUTURE REFERENCE READ CAREFULLY

See enclosed instructions for assembly, safety and care information.

Failure to follow the warnings could result in serious injury.

Handle heavy parts with care.

Ensure that this product is fully assembled as illustrated before use.

This product should only be used on firm, level ground.

Keep small parts out of reach of children.

Do not stand or climb onto this product.

This product is intended for **domestic use** only.

Furniture can be dangerous if incorrectly used. No liability will be accepted for damage or injury caused by incorrect use of this product.

This table is not intended to support a parasol separately. A parasol base with suitable weight must be used to support your parasol.



Dos

When you are ready to start, make sure that you have the right tools, plenty of space and a clean, dry area for assembly.

Removing all packaging and banding and place the components carefully on suitable surfaces to prevent damaging or scratching them.

Check the pack and make sure you have all of the parts listed.

Check all screws and bolts are tightened and inspect regularly.

We recommend the use of furniture covers to protect your product when not in use.

This product is suitable for all year outdoor use.

However to prolong its life we recommend that during severely bad weather and during the winter months, it is stored in a cool, dry place.

Before storage, ensure that the product is clean and dry.

To clean, wipe down with a sponge and warm soapy water and wipe with a clean, dry cloth.



Don'ts

Do not use scourers, abrasives, washing powders, chemical cleaners or any other substances containing abrasives since these substances can damage the product, including the glass panel.

Do not place very hot or very cold items on the glass surface unless adequately thick table-mats are used to prevent such items from coming into contact with the glass.

Do not use the glass as a chopping surface. Do not strike glass with hard or pointed items.

Do not strike the glass with hard or pointed items.

Do not use power tools to construct this product.

Do not use this product if parts are missing, damaged or worn.

Do not sit or lean on this product.

Do not stand or climb onto the product and do not use it as a ladder, as this could lead to it unbalancing and overturning.

Never drag furniture when moving it, always lift it.

Number of people required for assembly

Two people.



Time to assemble



30 Minutes

Tools required









Tips:

Do NOT fully tighten bolts before all components are connected. Only fully tighten once you are satisfied with the alignment of all components.

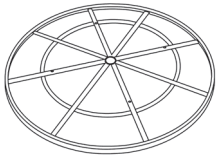
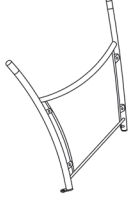
Do not overtighten bolts.

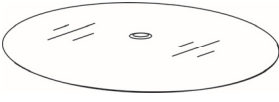
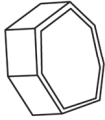
110/140cm Round Wicker Table Assembly Instructions

Components, fixtures & fittings (not actual size)

Parts List					
Part No.	Diagram	Qty	Part No.	Diagram	Qty
A	 Table Top Frame	1 PC	B	 Leg	2 PCS
C	 Connecting Panel	2 PCS	D	 Glass Top	1 PC
E	 Bolt Head Cap	12 PCS	F	 M6 Bolt	12 PCS
G	 Washer	12 PCS	H	 Spacer	8 PCS
I	 Spanner	1 PC			

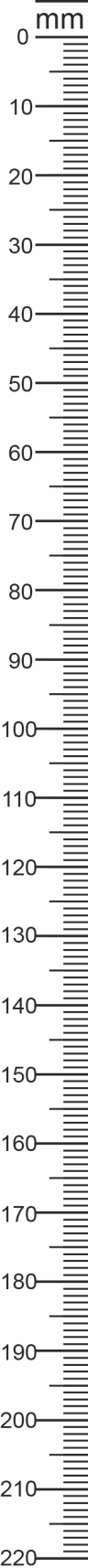

110/140cm Round Wicker Table Assembly Instructions

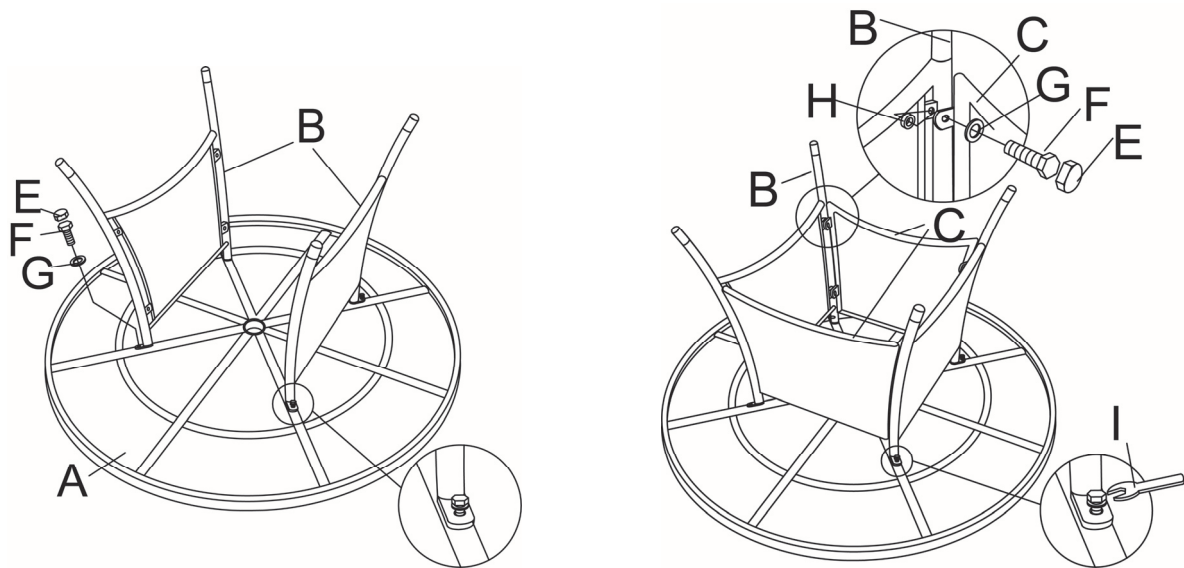

Step by step assembly instructions

Step One

Open the packaging with the glass face down on a flat surface. Leave the glass on the carton until the rest of the table is fully assembled.

With the help of another person, place Table Top Frame (A) upside down on a flat, non-abrasive surface to avoid scratching the table surface or rim.

Step Two

Do NOT assemble the Legs (B) to the Table Top Frame (A) while it is still resting on the Glass Top (D).

Loosely attach the Table Legs (B) to the Table Top Frame (A) using Washers (G) and Bolts (F).

110/140cm Round Wicker Table Assembly Instructions

Step Three

Loosely attach the Connecting Panels (C) onto the Table Top Frame (A) and Table Legs (B), aligning all holes in each part, using Spacers (H), Washers (G) and Bolts (F). Only tighten the bolts when all bolts and washers are in place. Once you are satisfied with the alignment of the components carefully tighten all bolts using Spanner (I).

Do not over-tighten.
Cover each bolt with Bolt Head Cap (E).

Step Four

With the help of another person, carefully turn the table in the upright position. Level the table by adjustable feet screw.

Carefully place the Glass Top (D) on the Table Top Frame (A) and make sure they are aligned. There are plastic suction caps pre-fitted onto the table top, make sure the glass top is in full contact with the plastic suction caps.

Your table is now ready for use.

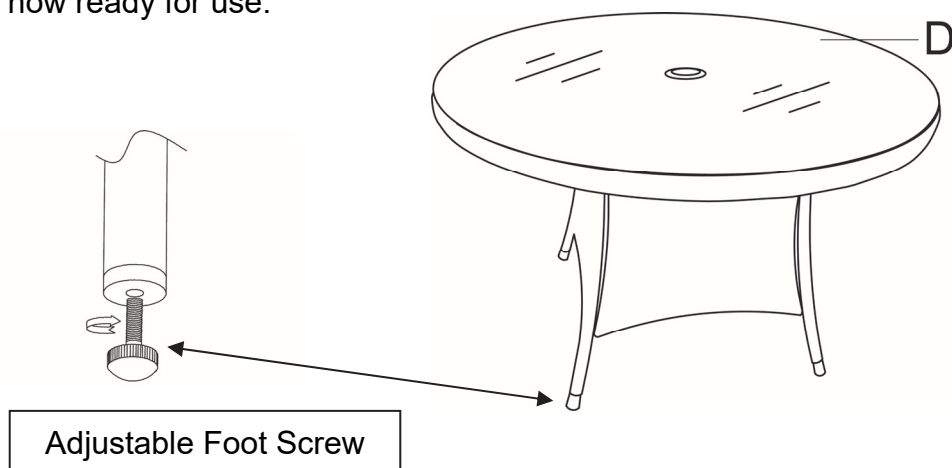

Note: This table is not designed to hold the parasol separately.

Parasol base with suitable weight should always be used.

PLEASE KEEP THESE INSTRUCTIONS FOR FUTURE REFERENCE