

MODEL: BRISTOL 60

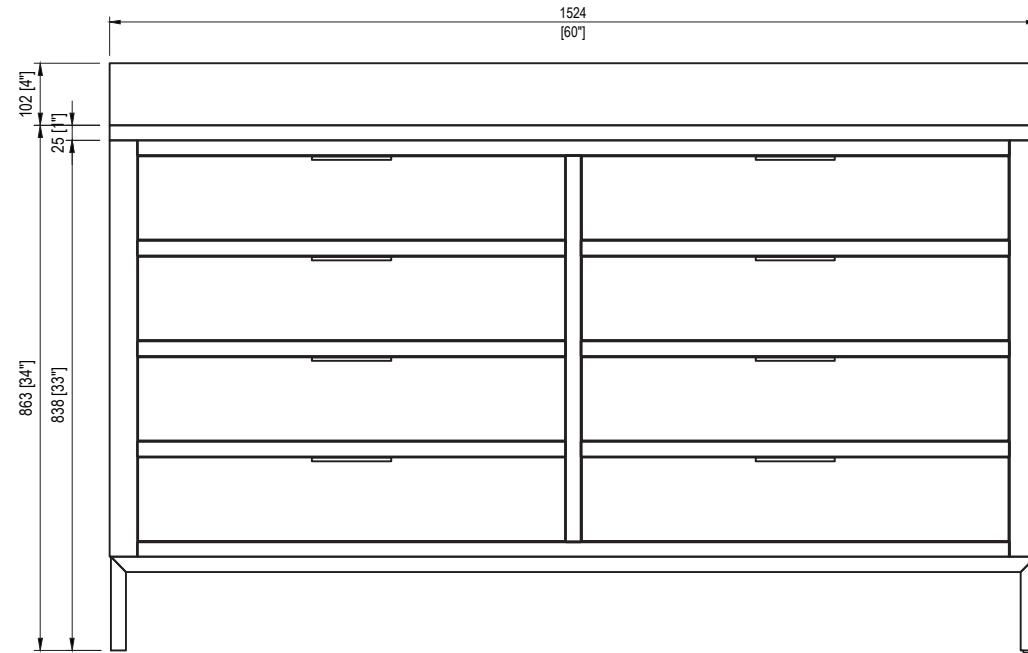

MODEL: BRISTOL 60

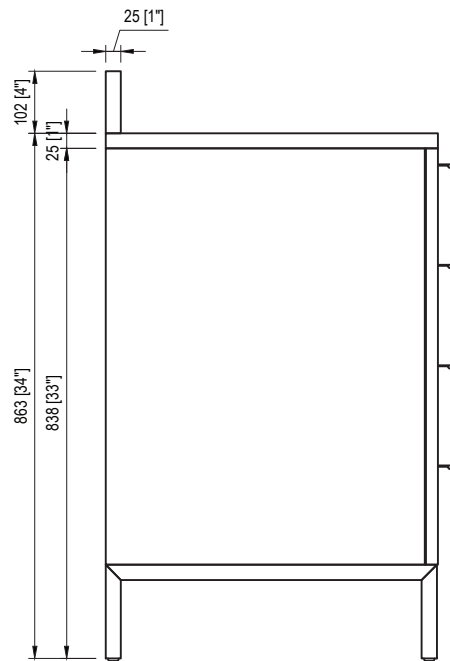
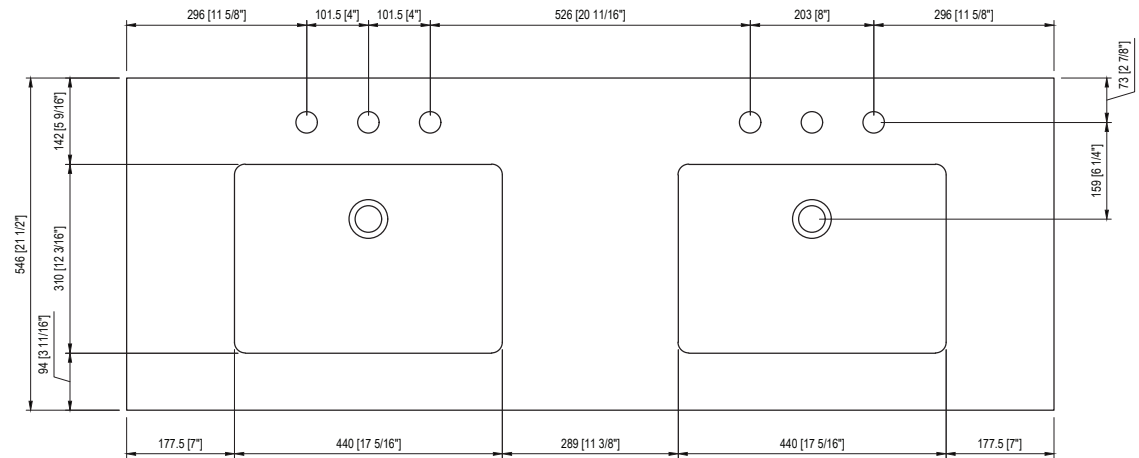
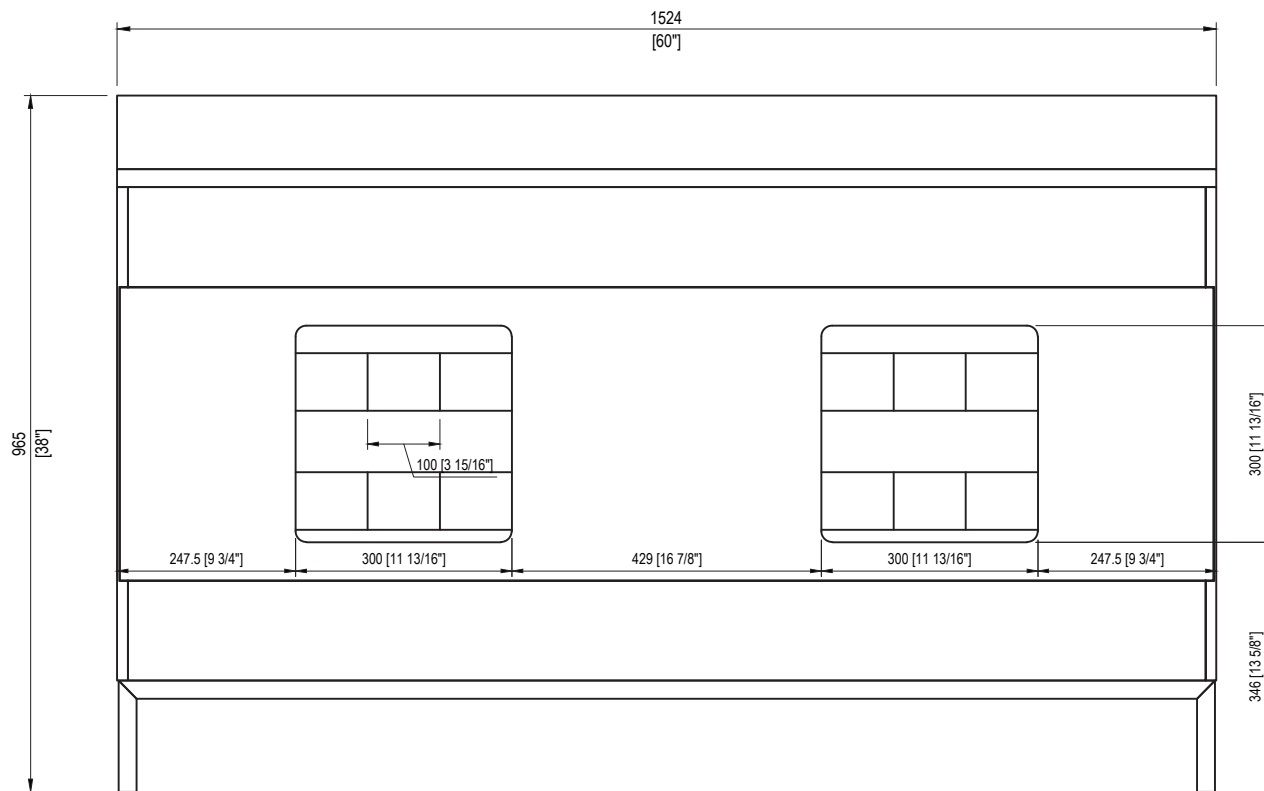

MODEL: BRISTOL 60

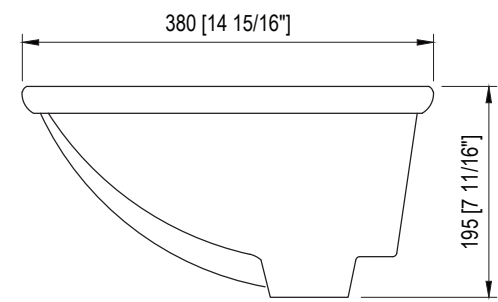
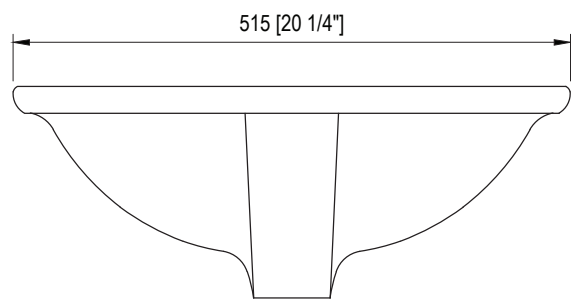
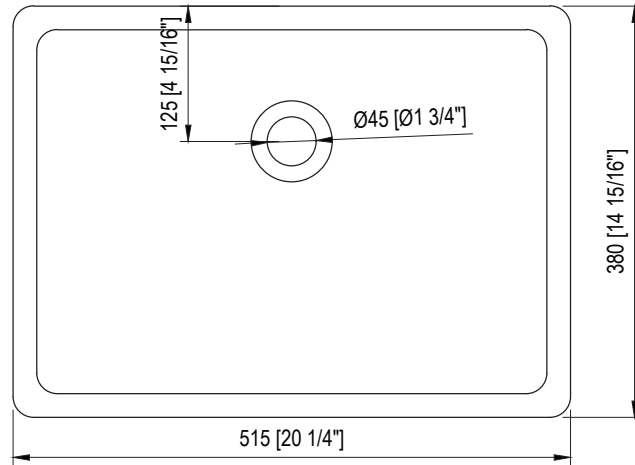

MODEL: BRISTOL 60

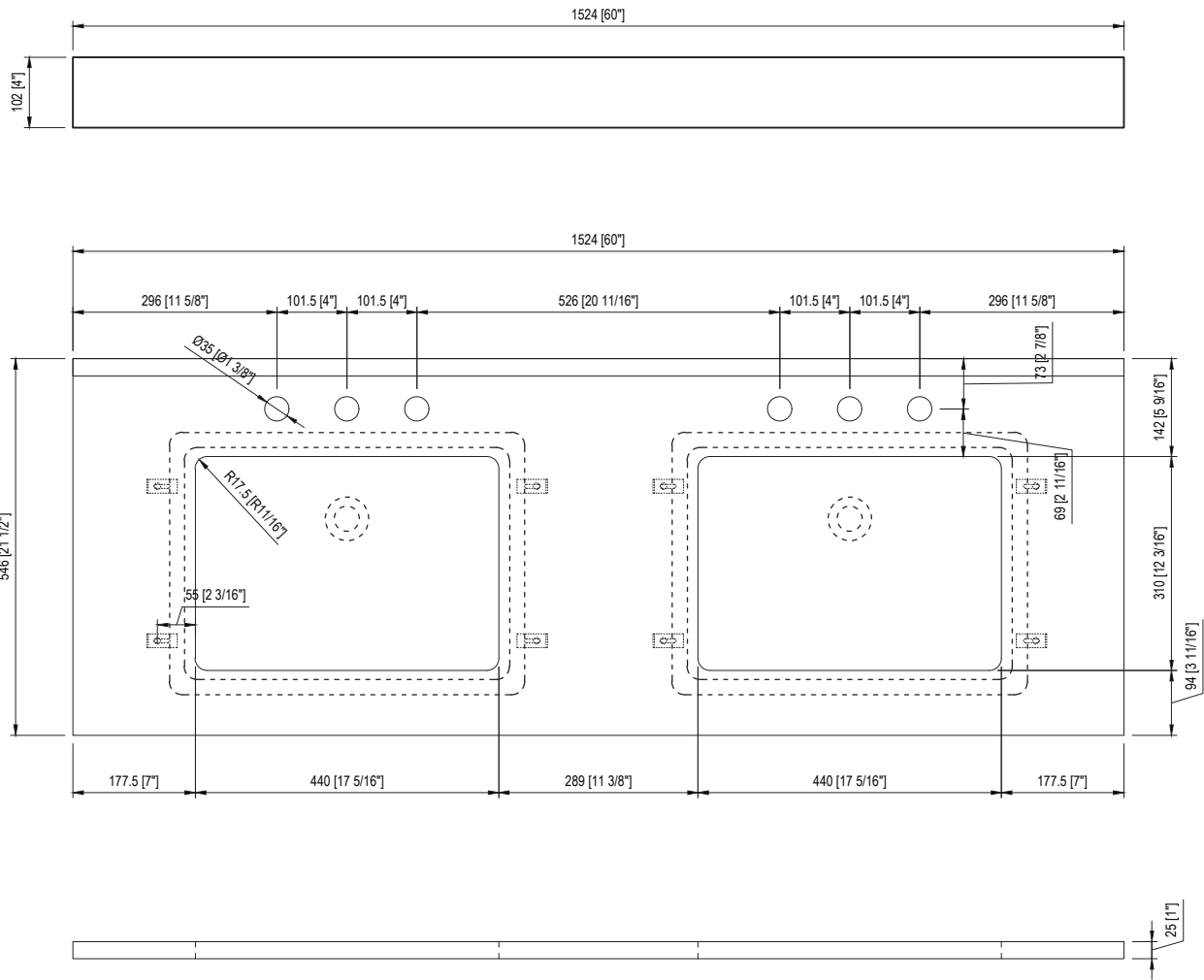

MODEL: RET-M-2136

