



## 20-Year Warranty

Great news! Your POLYWOOD warranty is already activated, no need to send anything in. Located on the bottom of each item is a sticker with a serial number. **Please keep this number for your records.**

View our full warranty:  
[polywood.com/warranty](http://polywood.com/warranty)



## Cleaning Tips

**For a Quick Clean:**  
Simply wipe down with soap and water.

**For a Deep Clean:**  
Wipe on 1/3 bleach and 2/3 water solution with a clean cloth and let it sit on the lumber for a few minutes (this will not affect the color). Then, loosen any dirt and debris that may catch in surface grooves with a soft bristle brush; hose down to rinse.

**For a High-Power Clean:**  
Use a pressure power washer (not exceeding 1,500 psi) to spray off dirt and debris. Apply a 1/3 bleach and 2/3 water solution and scrub with a soft bristle brush. Hose down to rinse.

# POLYWOOD®

## Assembly Instructions

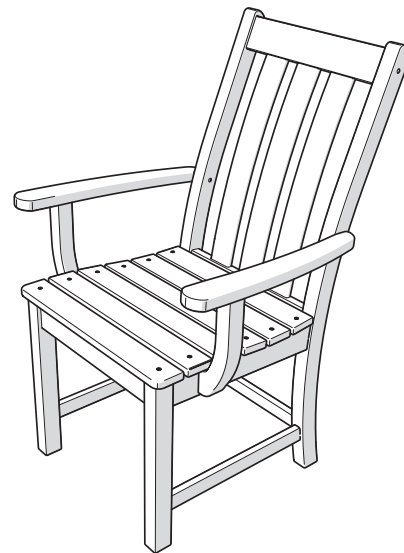

## VND230, VND231, VND232 Vineyard Arm Chair

[polywood.com](http://polywood.com)

# Thank You

Thank you for choosing POLYWOOD!  
We hope your new furniture helps create a gathering place for you and your loved ones to enjoy for many years to come!



## Join the POLYWOOD Community

Sign up at:  
[polywood.com/welcome](http://polywood.com/welcome)

You'll be the first to hear about new product launches, giveaways, special offers, and more!



## We're Always Here For You

If you have questions regarding assembly instructions, warranty claims, or missing parts, please visit our Help Center at [help.polywood.com](http://help.polywood.com)



## Watch & Learn

For assembly tips and videos visit:  
[polywood.com/assembly](http://polywood.com/assembly)

## Share Your Space

We love to see your furniture at home — share a photo or video and tag us for your chance to be featured!

#polywood



@POLYWOOD



[pinterest.com/polywood](https://pinterest.com/polywood)



[youtube.com/polywood](https://youtube.com/polywood)



[facebook.com/polywoodoutdoor](https://facebook.com/polywoodoutdoor)

Join thousands of fans in our Outdoor Living Community!  
[facebook.com/groups/polywoodoutdoorliving](https://facebook.com/groups/polywoodoutdoorliving)



## Did You Know?

Our long-lasting furniture is made using plastics that could otherwise pollute oceans and overwhelm landfills — and it can also be recycled when the time comes. Better for the planet, better for all.

Learn more about our story:  
[genuinePOLYWOOD.com](http://genuinePOLYWOOD.com)

## TOOLS

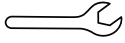

3/8" wrench  
(not included)

## PARTS

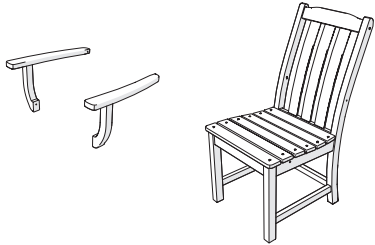

**A** x2



2.5" Screw — HHW14X2.5

**B** x2



Cap Dowel Screw — HD.25X2+P11420

# 1

Twist dowel screw into arm until finger-tight,  
remove protective cap

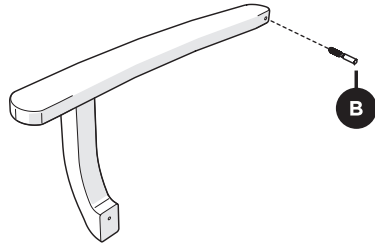

# 2

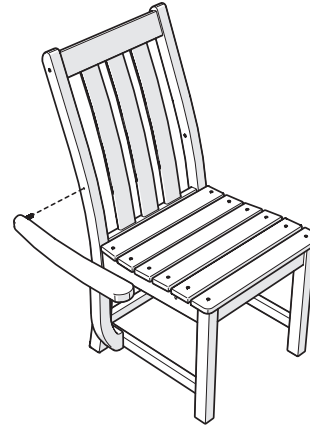

# 3

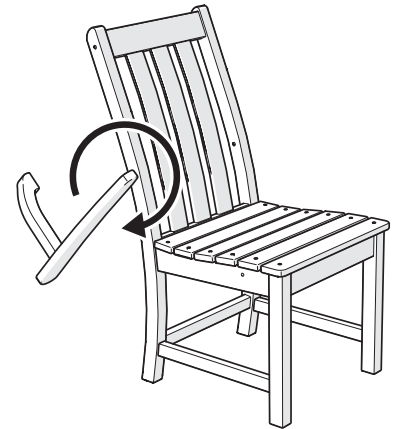

# 4

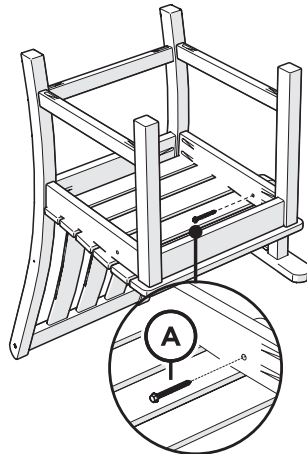

Repeat Steps 1 Thru 4 On Opposite Side

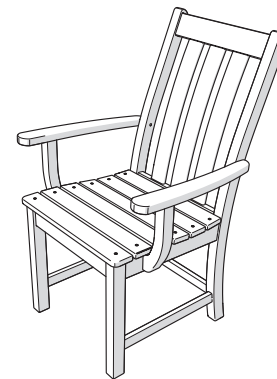

VND230

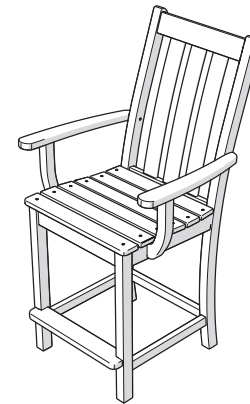

VND231

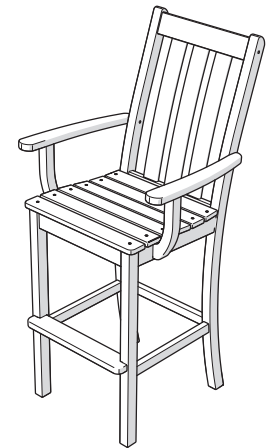

VND232



Remove protective plastic  
film from the logo medallion.

Something missing?  
Visit [help.polywood.com](http://help.polywood.com)

# POLYWOOD®