

# Assembly Instructions

## Item - BA219 - SC

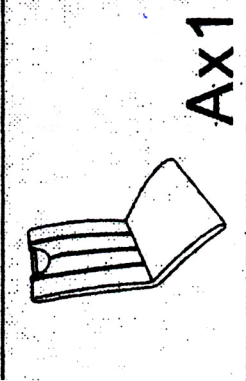

**Best Master Furniture™**  
The Imported Furniture Specialist

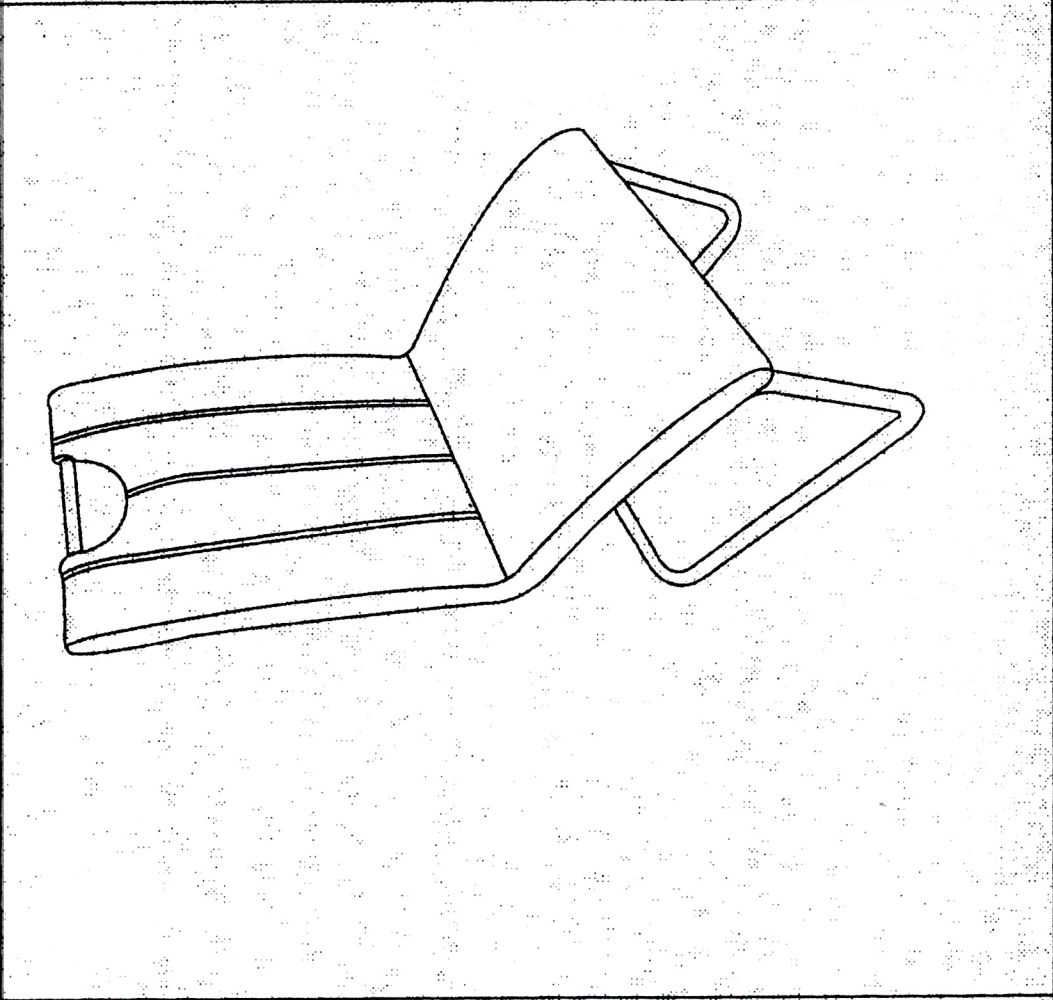
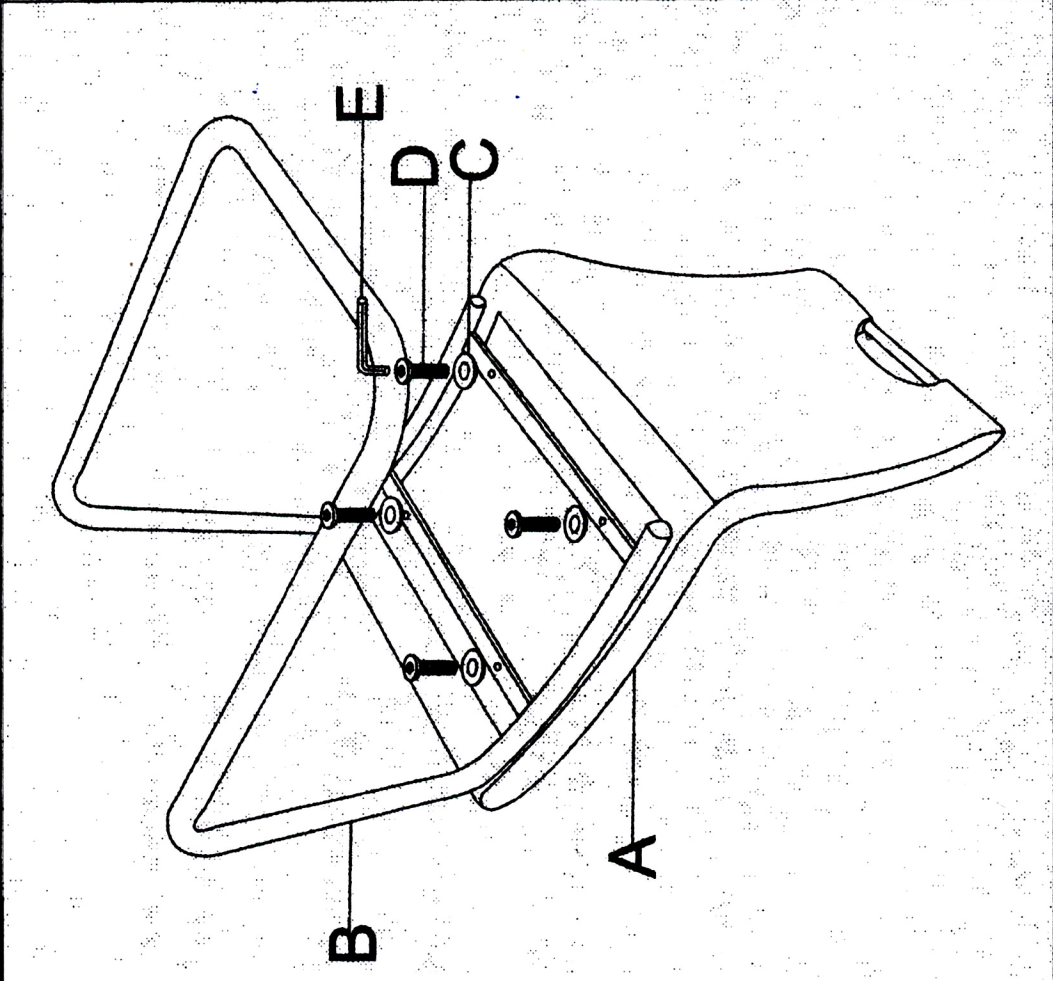

**Ax1**

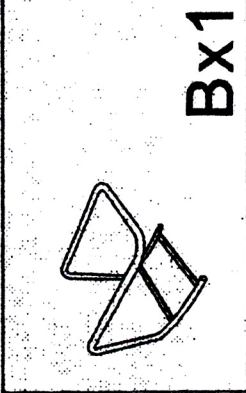

**Bx1**

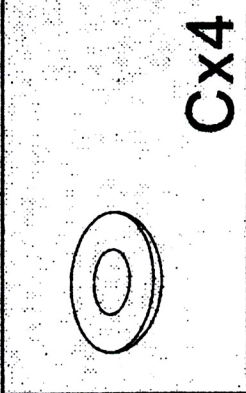

**Cx4**

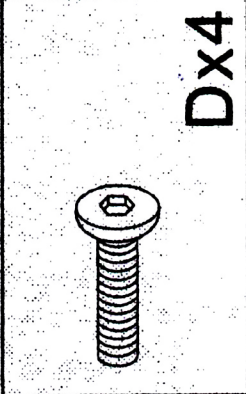

**Dx4**

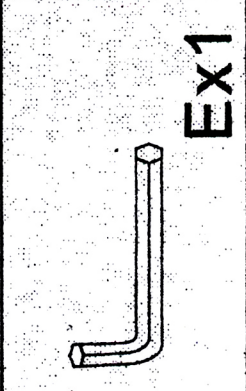

**Ex1**