



# ASSEMBLY INSTRUCTIONS

## NIGHTSTAND

**NOTE: THIS ITEM NOT RECOMMENDED FOR COMMERCIAL USE  
KEEP THIS DOCUMENT FOR REFERENCE IN CASE PARTS ARE NEEDED  
DO NOT TIGHTEN SCREWS UNTIL COMPLETELY ASSEMBLE !!**

NO.	PART LIST	QTY	NO.	HARDWARE LIST	QTY
A	 NIGHTSTAND	1 PC	1	 USB ADAPTER	1 PC

**Notice:** there is a USB device at the back side of the case, please connect the adapter to the USB cable then plug it into the electric outlet before using.

### STEP 1

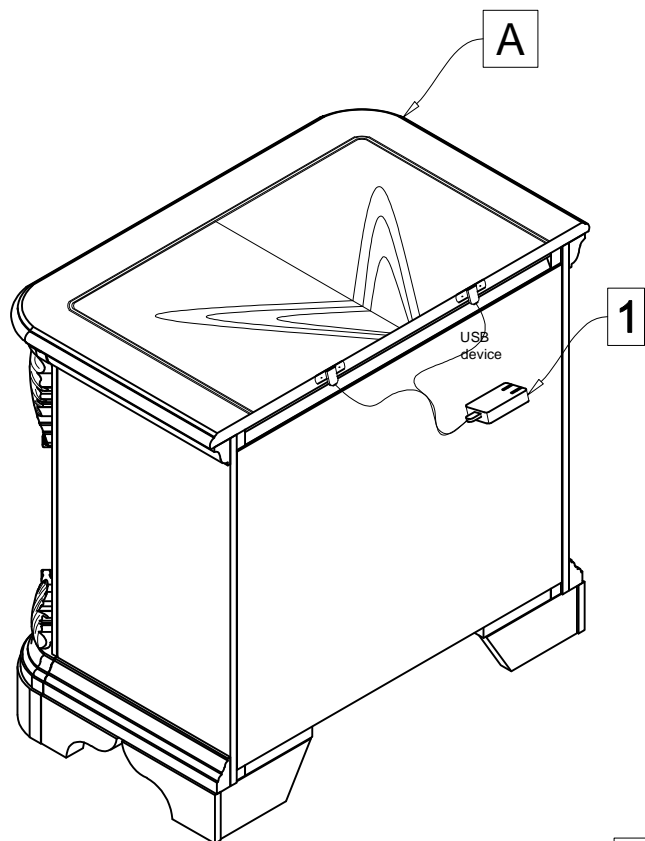
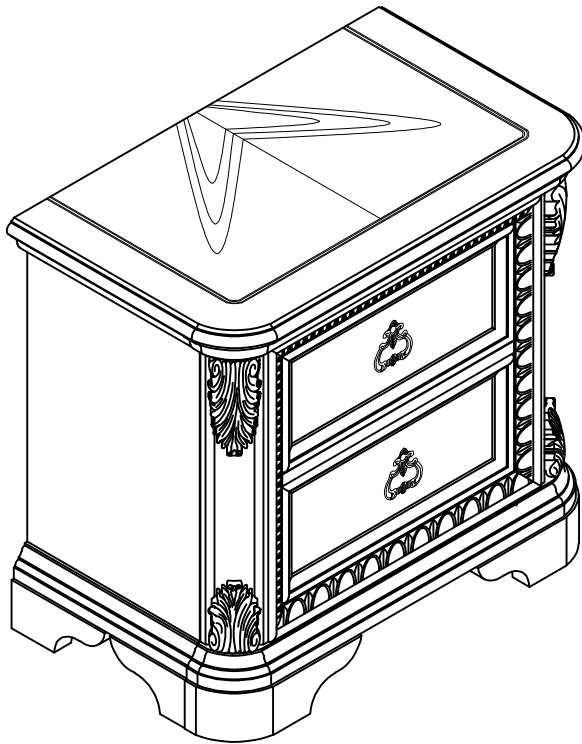

# ASSEMBLY INSTRUCTIONS

## CHEST

**NOTE: THIS ITEM NOT RECOMMENDED FOR COMMERCIAL USE  
KEEP THIS DOCUMENT FOR REFERENCE IN CASE PARTS ARE NEEDED  
DO NOT TIGHTEN SCREWS UNTIL COMPLETELY ASSEMBLE !!**

NO.	PART LIST	QTY
A	 CHEST	1 PC

NO	HARDWARE LIST	QTY
1	 ANTI-TIPPING KIT	1 PC

Remark: There is a tipping restraint kit attached to  
★ the back of this product. Please read the directions  
thoroughly and install immediately before use.

### STEP 1

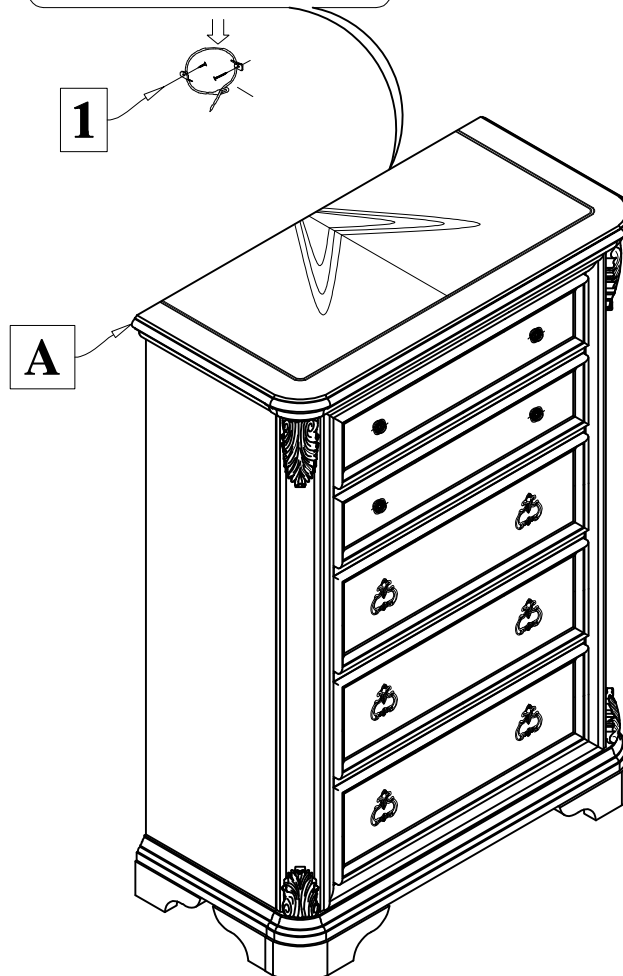

# ASSEMBLY INSTRUCTIONS

## DRESSER

**NOTE: THIS ITEM NOT RECOMMENDED FOR COMMERCIAL USE  
KEEP THIS DOCUMENT FOR REFERENCE IN CASE PARTS ARE NEEDED  
DO NOT TIGHTEN SCREWS UNTIL COMPLETELY ASSEMBLE !!**

NO	PART LIST	QTY
A	 DRESSER	1 PC

NO	HARDWARE LIST	QTY
1	 ANTI-TIPPING KIT	1 PC

### STEP 1

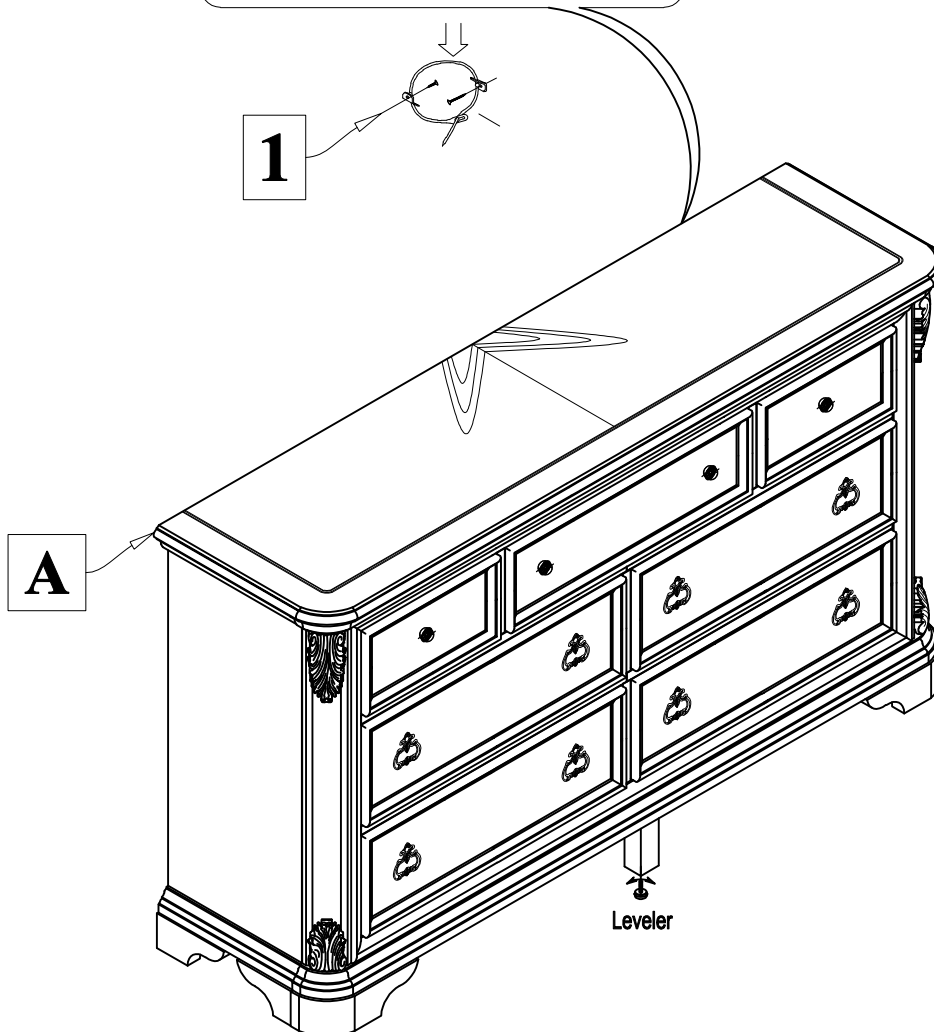

Remark: There is a tipping restraint kit attached to ★ the back of this product. Please read the directions thoroughly and install immediately before use.







# ASSEMBLY INSTRUCTIONS

## MIRROR

**NOTE: THIS ITEM NOT RECOMMENDED FOR COMMERCIAL USE  
KEEP THIS DOCUMENT FOR REFERENCE IN CASE PARTS ARE NEEDED  
DO NOT TIGHTEN SCREWS UNTIL COMPLETELY ASSEMBLE !!**

NO		PART LIST	QTY
A		DRESSER	1 PC
B		MIRROR	1 PC
C		MIRROR SUPPORT IN MIRROR BOX	2 PCS

NO		HARDWARE LIST		QTY
1		ALLEN KEY	L57 x 4mm	1 PC
2		BOLT	Φ1/4"*1 - 1/2"	8 PCS
3		SPRING WASHER	Φ1/4"*13*1.5mm	8 PCS
4		FLAT WASHER	Φ1/4"*19*1.5mm	8 PCS

### STEP 1

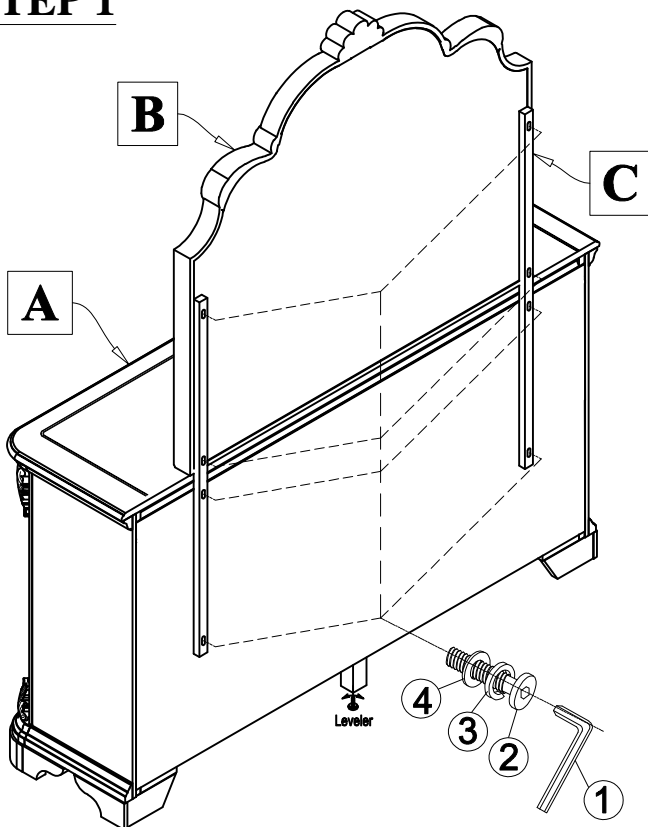



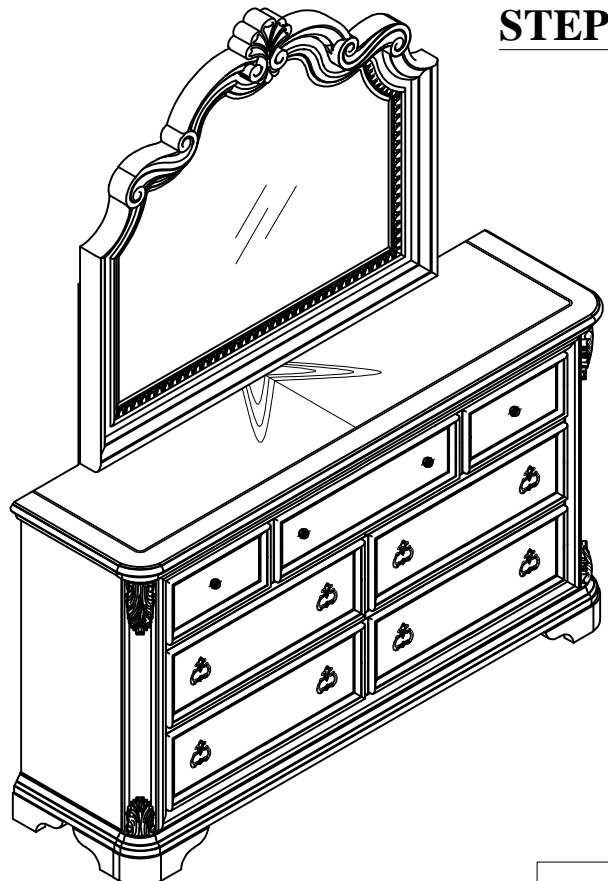



### STEP 2















# ASSEMBLY INSTRUCTIONS

## KING UPH PANEL HEADBOARD KING PANEL FOOTBOARD AND SLATS QUEEN/ KING SIDE RAILS

**NOTE: THIS ITEM NOT RECOMMENDED FOR COMMERCIAL USE  
KEEP THIS DOCUMENT FOR REFERENCE IN CASE PARTS ARE NEEDED  
DO NOT TIGHTEN SCREWS UNTIL COMPLETELY ASSEMBLE !!**

NO	PART LIST		QTY
A		King Headboard	1 PC
B		King Footboard	1 PC
C		Queen/King Side Rails (L/R)	2 PCS
D		Headboard Leg (L/R)	2 PCS
E		Stretcher	1 PC
F		Slat	4 PCS
G		Support Leg	8 PCS

NO	HARDWARE LIST			QTY
1		ALLEN KEY	L57 x 4mm	1 PC
2		BOLT	Φ1/4"*1 - 1/2"	2 PCS
3		SPRING WASHER	Φ1/4"*13*1.2mm	2 PCS
4		FLAT WASHER	Φ1/4"*19*1.8mm	2 PCS
5		BOLT	Φ5/16"*2-1/4"	6 PCS
6		SPRING WASHER	Φ5/16"*13*1.2mm	6 PCS
7		FLAT WASHER	Φ5/16"*19*1.8mm	6 PCS
* Above Hardware packed in 1988-112HK for assembly.				
8		BOLT	Φ5/16"*3"	8 PCS
9		"C" WASHER	Φ5/16"	8 PCS
10		SPRING WASHER	Φ5/16"*13*1.2mm	8 PCS
11		NUT	Φ5/16"*16mm	8 PCS
12		HEX WRENCH		1 PC
13		SCREW/ VIS	#8*30mm	8 PCS

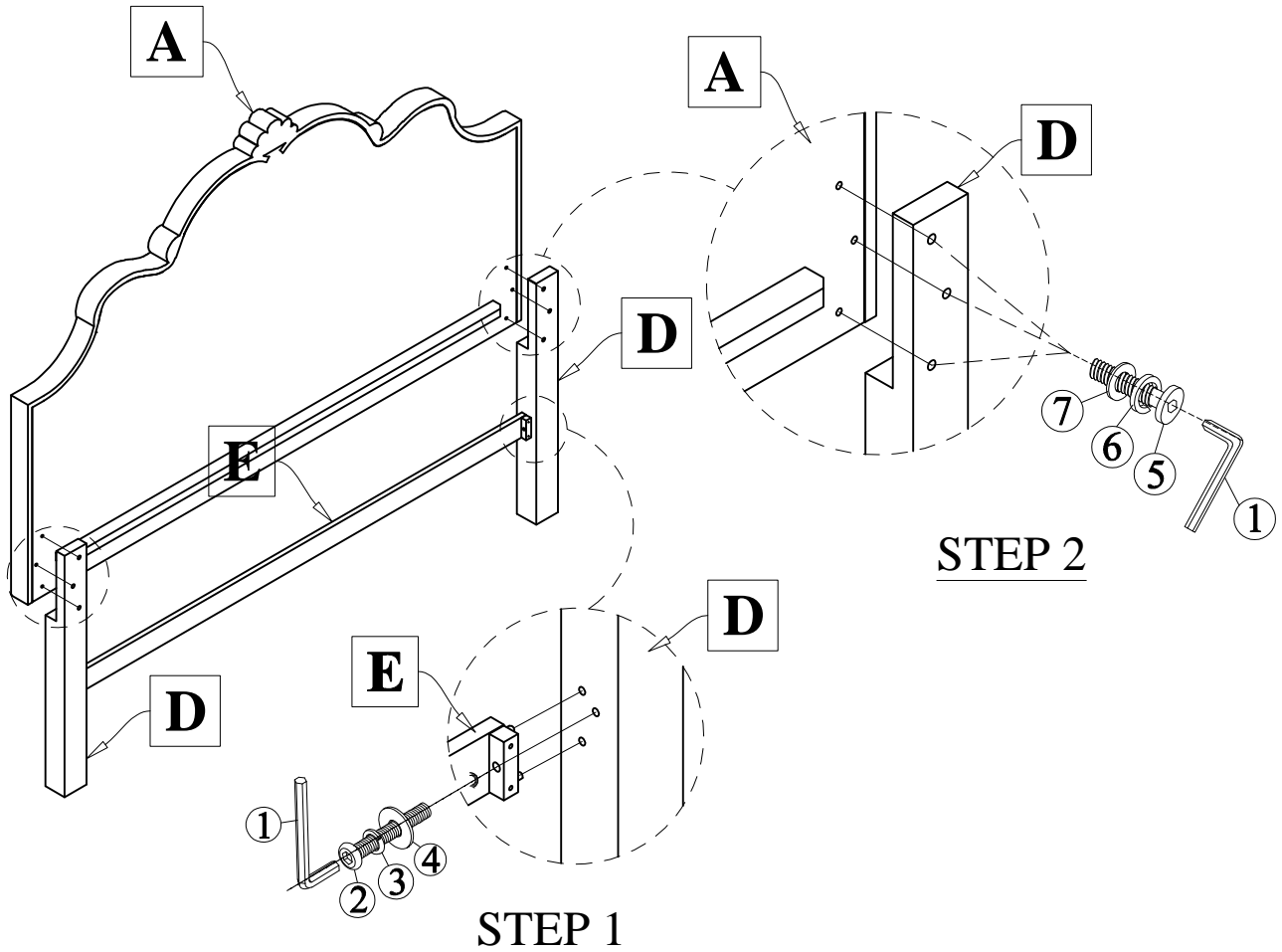

# ASSEMBLY INSTRUCTIONS



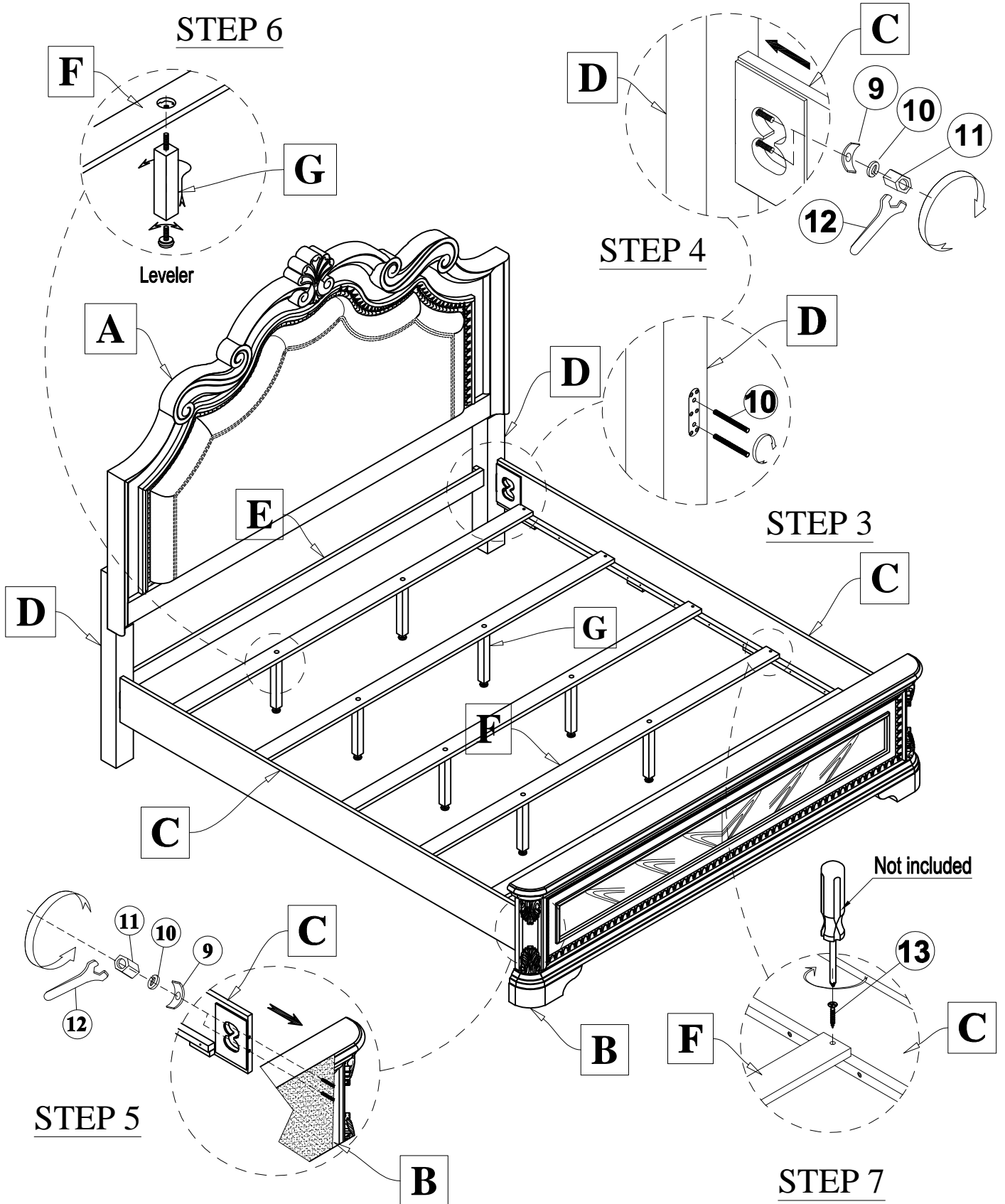



KING UPH PANEL HEADBOARD  
KING PANEL FOOTBOARD AND SLATS  
QUEEN/ KING SIDE RAILS







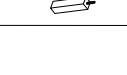







# ASSEMBLY INSTRUCTIONS

**QUEEN UPH PANEL HEADBOARD  
QUEEN PANEL FOOTBOARD AND SLATS  
QUEEN/ KING SIDE RAILS**

**NOTE: THIS ITEM NOT RECOMMENDED FOR COMMERCIAL USE  
KEEP THIS DOCUMENT FOR REFERENCE IN CASE PARTS ARE NEEDED  
DO NOT TIGHTEN SCREWS UNTIL COMPLETELY ASSEMBLE !!**

NO	PART LIST		QTY
A		Queen Headboard	1 PC
B		Queen Footboard	1 PC
C		Queen/King Side Rails (L/R)	2 PCS
D		Headboard Leg (L/R)	2 PCS
E		Stretcher	1 PC
F		Slat	4 PCS
G		Support Leg	4 PCS

NO	HARDWARE LIST			QTY
1		ALLEN KEY	L57 x 4mm	1 PC
2		BOLT	Φ1/4"*1 - 1/2"	2 PCS
3		SPRING WASHER	Φ1/4"*13*1.2mm	2 PCS
4		FLAT WASHER	Φ1/4"*19*1.8mm	2 PCS
5		BOLT	Φ5/16"*2-1/4"	6 PCS
6		SPRING WASHER	Φ5/16"*13*1.2mm	6 PCS
7		FLAT WASHER	Φ5/16"*19*1.8mm	6 PCS
* Above Hardware packed in 1988-107HQ for assembly.				
8		BOLT	Φ5/16"*3"	8 PCS
9		"C" WASHER	Φ5/16"	8 PCS
10		SPRING WASHER	Φ5/16"*13*1.2mm	8 PCS
11		NUT	Φ5/16"*16mm	8 PCS
12		HEX WRENCH		1 PC
13		SCREW/ VIS	#8*30mm	8 PCS
* Above Hardware packed in 1988-105FQ for assembly.				

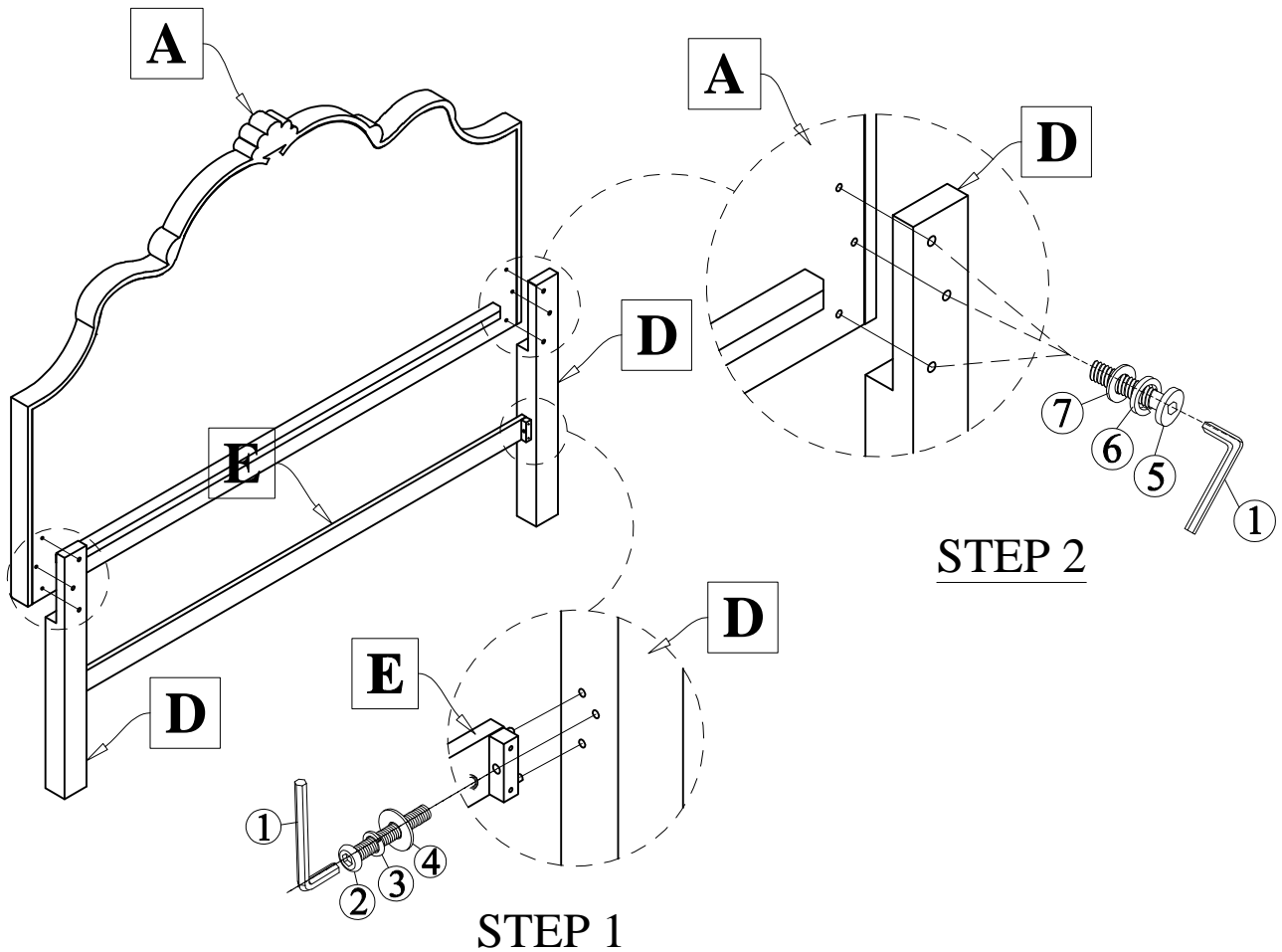

# ASSEMBLY INSTRUCTIONS

QUEEN UPH PANEL HEADBOARD  
QUEEN PANEL FOOTBOARD AND SLATS  
QUEEN/ KING SIDE RAILS

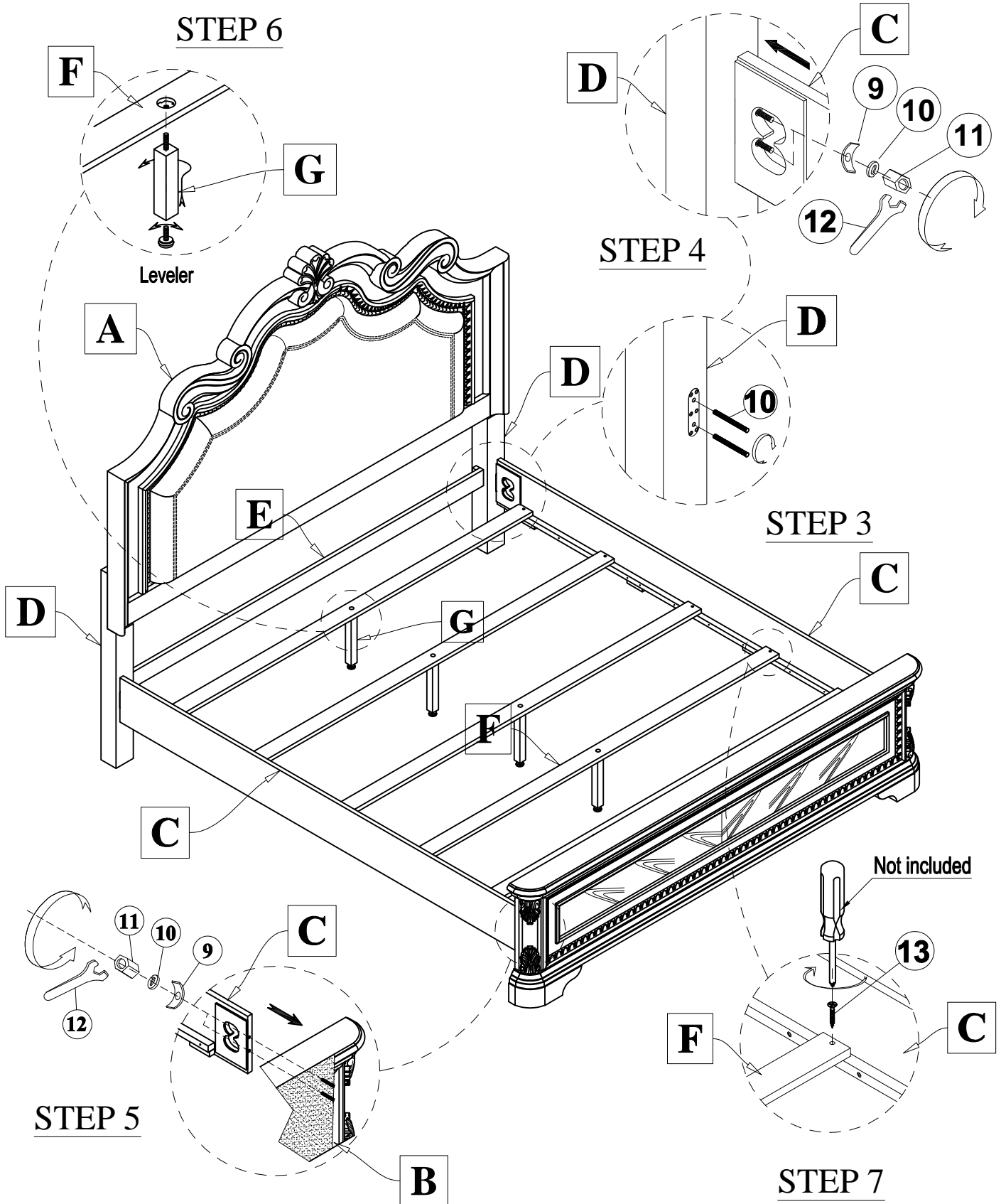

# ASSEMBLY INSTRUCTIONS

**KING CANOPY UPH HEADBOARD  
 KING CANOPY FOOTBOARD AND SLATS  
 QUEEN/ KING SIDE RAILS  
 KING CANOPY FRAME  
 BED POSTS (4 PCS)**

**NOTE: THIS ITEM NOT RECOMMENDED FOR COMMERCIAL USE  
 KEEP THIS DOCUMENT FOR REFERENCE IN CASE PARTS ARE NEEDED  
 DO NOT TIGHTEN SCREWS UNTIL COMPLETELY ASSEMBLE !!**

NO	PART LIST		QTY
A		King Headboard	1 PC
B		King Footboard	1 PC
C		Queen/King Side Rails (L/R)	2 PCS
D		Headboard Post (L/R)	2 PCS
E		Footboard Post (L/R)	2 PCS
F		Slat	4 PCS
G		Support Leg	8 PCS
H		Canopy corner	4 PCS
I		Canopy panel (Top and Bottom)	2 PCS
K		Canopy side panels	2 PCS

NO	HARDWARE LIST			QTY
1		ALLEN KEY	L57 x 4mm	1 PC
2		BOLT	Φ5/16"*2-1/4"	8 PCS
3		SPRING WASHER	Φ5/16"*13*1.2mm	8 PCS
4		FLAT WASHER	Φ5/16"*19*1.8mm	8 PCS
5		ALLEN KEY	L57 x 4mm	1 PC
6		BOLT	Φ5/16"*2-1/4"	6 PCS
7		SPRING WASHER	Φ5/16"*13*1.2mm	6 PCS
8		FLAT WASHER	Φ5/16"*19*1.8mm	6 PCS
9		SCREW/ VIS	#8*30mm	8 PCS
10		BOLT	Φ5/16"*3"	8 PCS
11		"C" WASHER	Φ5/16"	8 PCS
12		SPRING WASHER	Φ5/16"*13*1.2mm	8 PCS
13		NUT	Φ5/16"*16mm	8 PCS
14		HEX WRENCH		1 PC
15		ALLEN KEY	L57 x 4mm	1 PC
16		BOLT	Φ1/4"*5/8"	16 PCS
17		SPRING WASHER	Φ1/4"*13*1.2mm	16 PCS
18		FLAT WASHER	Φ1/4"*13*1.8mm	16 PCS

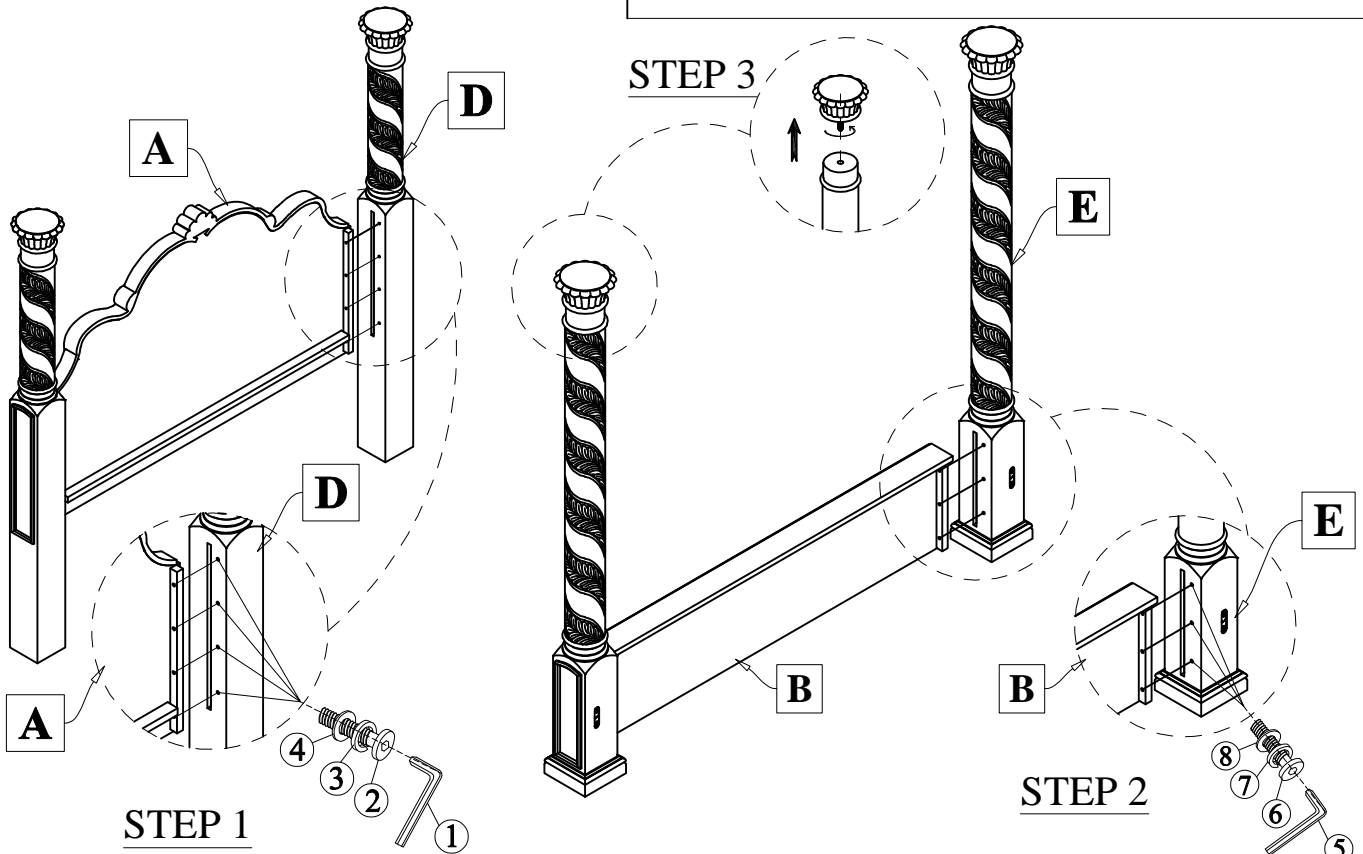

# ASSEMBLY INSTRUCTIONS

KING CANOPY UPH HEADBOARD  
KING CANOPY FOOTBOARD AND SLATS  
QUEEN/ KING SIDE RAILS  
KING CANOPY FRAME  
BED POSTS (4 PCS)

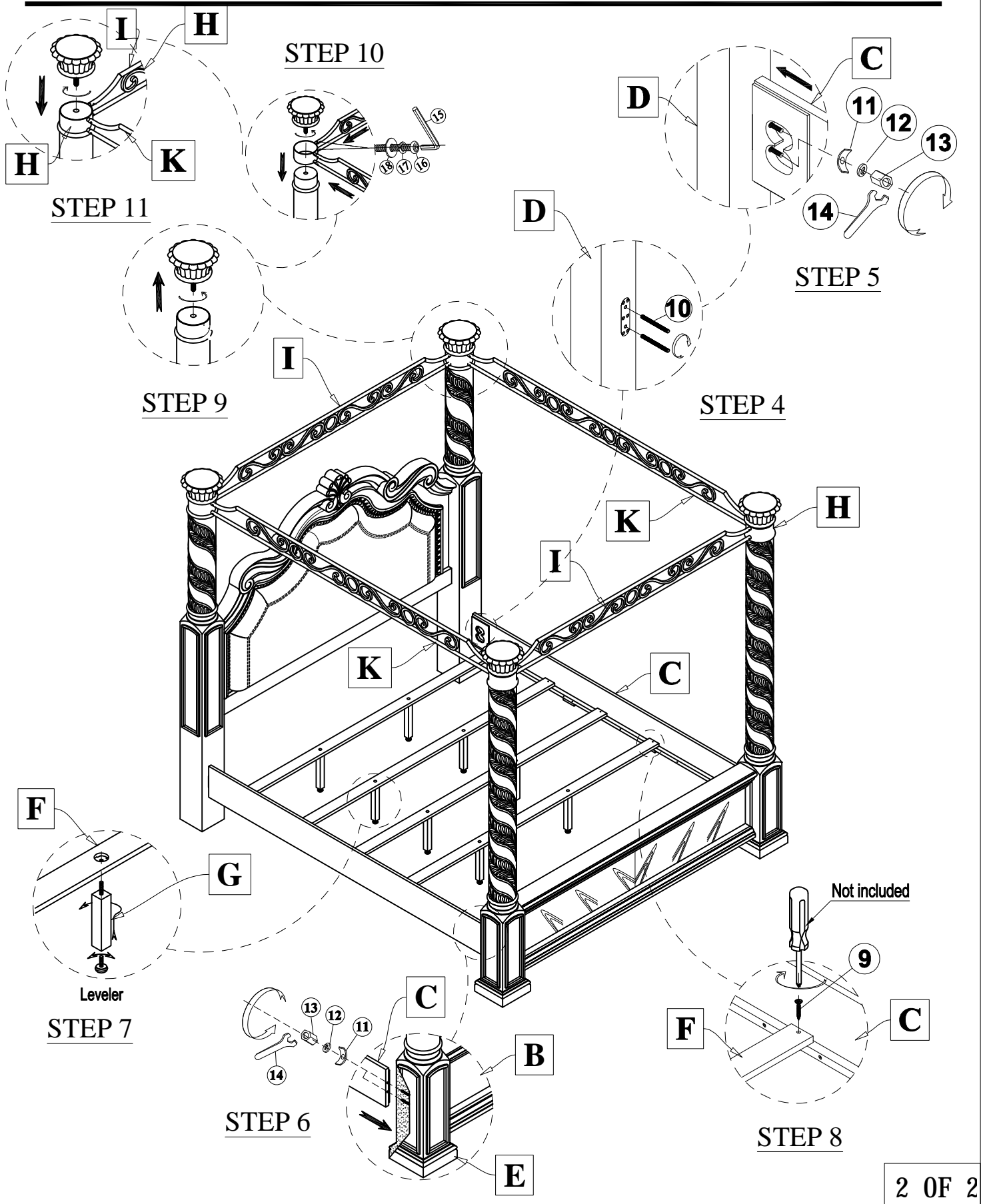

# ASSEMBLY INSTRUCTIONS

## QUEEN CANOPY UPH HEADBOARD

QUEEN/ KING SIDE RAILS  
 QUEEN CANOPY FRAME  
 BED POSTS (4 PCS)

**NOTE: THIS ITEM NOT RECOMMENDED FOR COMMERCIAL USE  
 KEEP THIS DOCUMENT FOR REFERENCE IN CASE PARTS ARE NEEDED  
 DO NOT TIGHTEN SCREWS UNTIL COMPLETELY ASSEMBLE !!**

NO	PART LIST		QTY
A		Queen Headboard	1 PC
B		Queen Footboard	1 PC
C		Queen/King Side Rails (L/R)	2 PCS
D		Headboard Post (L/R)	2 PCS
E		Footboard Post (L/R)	2 PCS
F		Slat	4 PCS
G		Support Leg	4 PCS
H		Canopy corner	4PCS
I		Canopy panel (Top and Bottom)	2PCS
K		Canopy side panels	2PCS

NO	HARDWARE LIST			QTY
1		ALLEN KEY	L57 x 4mm	1 PC
2		BOLT	Φ5/16"*2-1/4"	8 PCS
3		SPRING WASHER	Φ5/16"*13*1.2mm	8 PCS
4		FLAT WASHER	Φ5/16"*19*1.8mm	8 PCS
5		ALLEN KEY	L57 x 4mm	1 PC
6		BOLT	Φ5/16"*2-1/4"	6 PCS
7		SPRING WASHER	Φ5/16"*13*1.2mm	6 PCS
8		FLAT WASHER	Φ5/16"*19*1.8mm	6 PCS
9		SCREW/ VIS	#8*30mm	8 PCS
10		BOLT	Φ5/16"*3"	8 PCS
11		"C" WASHER	Φ5/16"	8 PCS
12		SPRING WASHER	Φ5/16"*13*1.2mm	8 PCS
13		NUT	Φ5/16"*16mm	8 PCS
14		HEX WRENCH		1 PC
15		ALLEN KEY	L57 x 4mm	1 PC
16		BOLT	Φ1/4"*5/8"	16 PCS
17		SPRING WASHER	Φ1/4"*13*1.2mm	16 PCS
18		FLAT WASHER	Φ1/4"*13*1.8mm	16 PCS

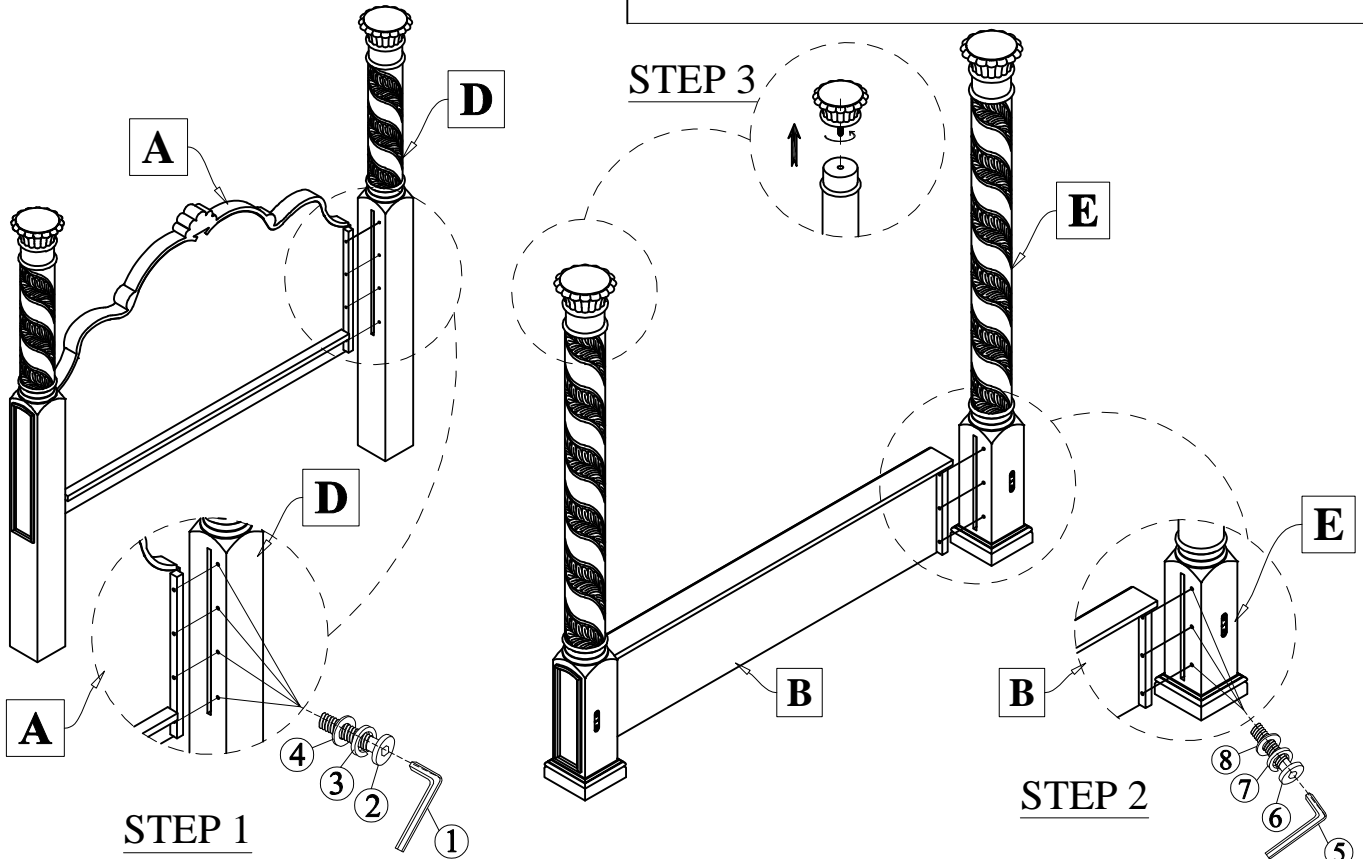

# ASSEMBLY INSTRUCTIONS

QUEEN CANOPY UPH HEADBOARD  
QUEEN CANOPY FOOTBOARD AND SLATS  
QUEEN/ KING SIDE RAILS  
QUEEN CANOPY FRAME  
BED POSTS (4 PCS)

