

Pure & Easy



ASSEMBLY INSTRUCTIONS



FTPLCG-01135
FTPLCG-01136
FTPLCG-01137

FTPLCG-01138
FTPLCG-01139
FTPLCG-01140

LHHY-V1

NOTICE

IMPORTANT, RETAIN FOR FUTURE REFERENCE: READ CAREFULLY
WICHTIG, FÜR SPÄTERE NACHSCHLAGE AUFBEWAHREN: SORGFÄLTIG LESEN
IMPORTANTE, GUARDAR PARA REFERENCIA FUTURA: LEER ATENTAMENTE
IMPORTANTE, CONSERVARE PER RIFERIMENTI FUTURI: LEGGERE ATTENTAMENTE
IMPORTANT, À CONSERVER POUR RÉFÉRENCE FUTURE : LIRE ATTENTIVEMENT

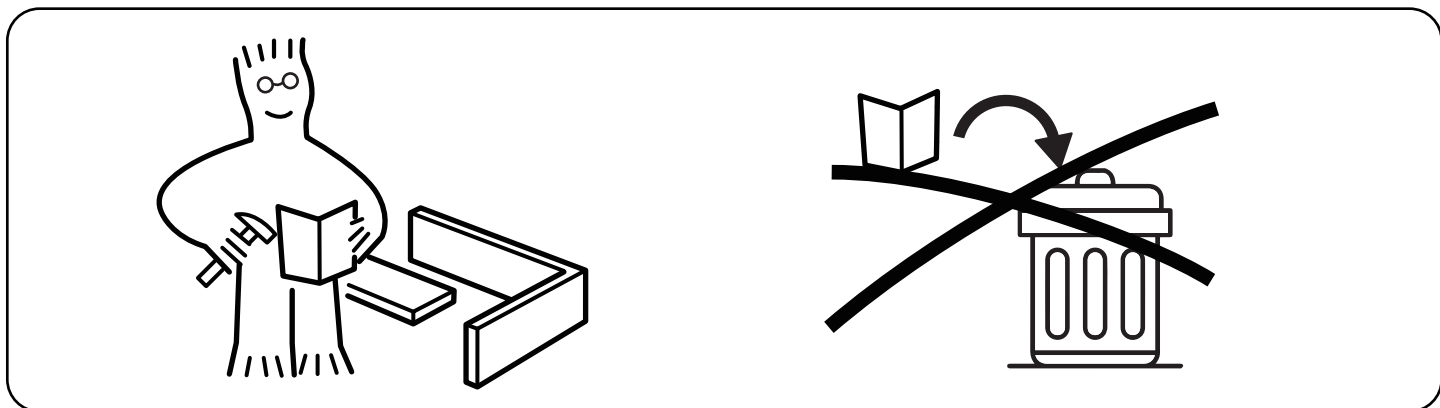

Assemble on a flat and solid surface. To avoid the unstable surface affecting the overall frame stability during installation.

Montieren Sie auf einer ebenen und festen Oberfläche. Um zu verhindern, dass eine unebene Oberfläche während der Montage die Gesamtrahmen-Stabilität beeinträchtigt.

Ensamblar en una superficie plana y sólida. Afin d'éviter que la surface inégale n'affecte la stabilité générale du cadre lors de l'installation.

Assemblare su una superficie piana e solida. Per evitare che una superficie irregolare influisca sulla stabilità complessiva della struttura durante l'installazione.

Assembler sur une surface plate et solide. Para evitar que la instalación en una superficie irregular afecte la estabilidad general del marco.

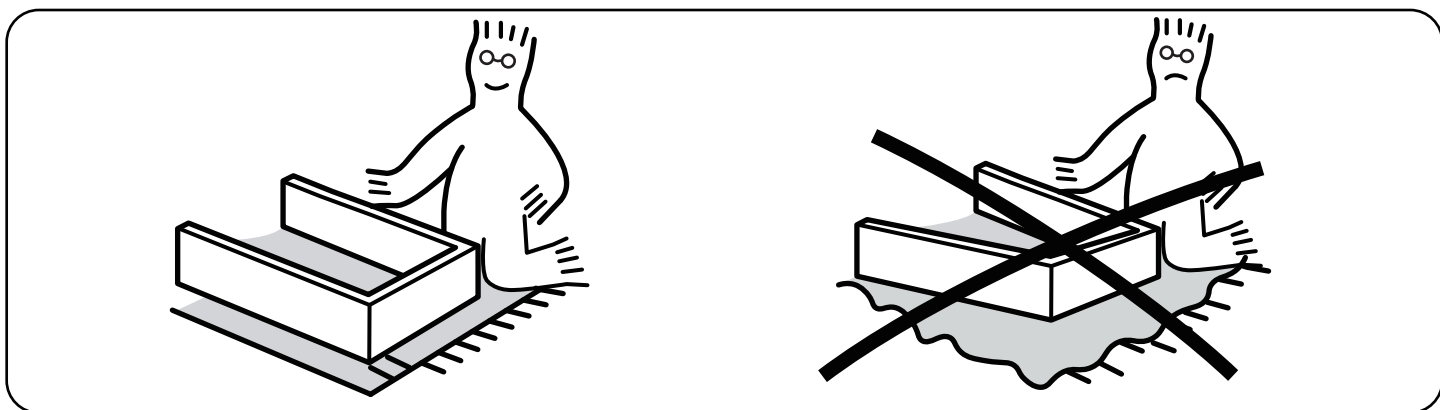

Professional installation is highly recommended.

Eine professionelle Installation wird dringend empfohlen.

Une installation professionnelle est fortement recommandée.

Si raccomanda vivamente l'installazione professionale.

Se recomienda altamente la instalación profesional.



Periodically Check That All Components Are Tightly Secured.
Überprüfen Sie Regelmäßig, Dass Alle Komponenten Fest Gesichert Sind.
Vérifiez Périodiquement Que Tous Les Composants Sont Bien Fixés.
Controllare Periodicamente Che Tutti I Componenti Siano Ben Fissati.
Verifique Periódicamente Que Todos Los Componentes Estén Bien Asegurados.



It is recommended that multiple people assemble this product.
Es wird empfohlen, dass mehrere Personen dieses Produkt zusammenbauen.
Il est recommandé que plusieurs personnes assemblent ce produit.
Si raccomanda che più persone assemblino questo prodotto.
Se recomienda que varias personas ensamblen este producto.

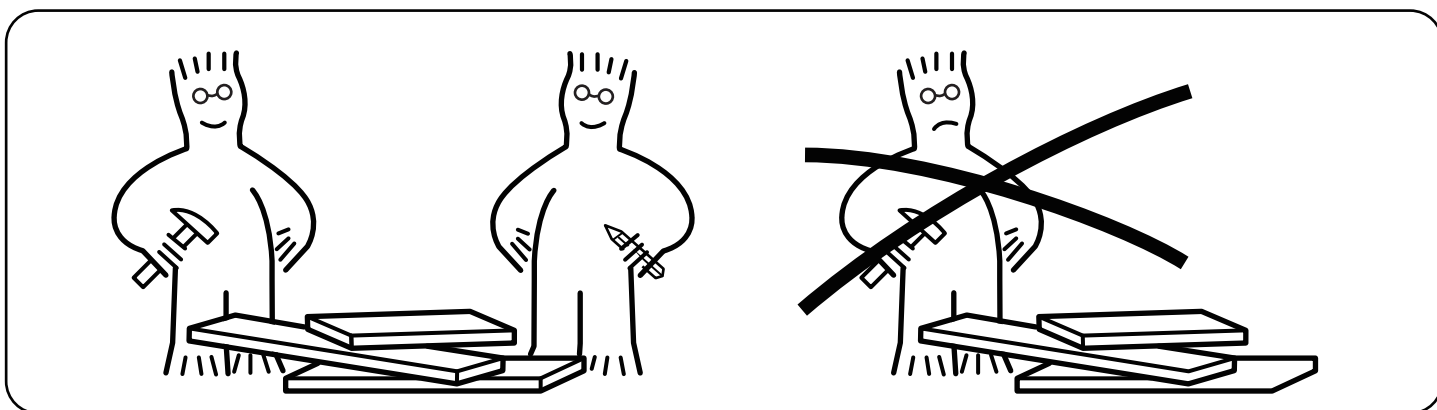

Please contact us if parts of your furniture are missing.
Bitte kontaktieren Sie uns, wenn Teile Ihrer Möbel fehlen.
Por favor contáctenos si faltan piezas de sus muebles.
Si prega di contattarci se mancano parti dei vostri mobili.
Veuillez nous contacter si des pièces de vos meubles manquent.



Please have the following auxiliary tools ready:

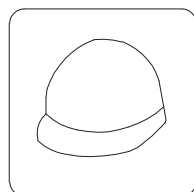
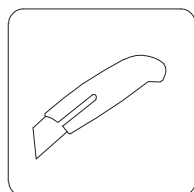
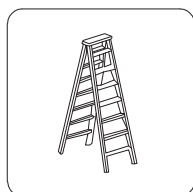
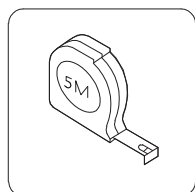
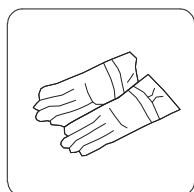
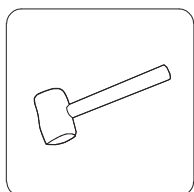
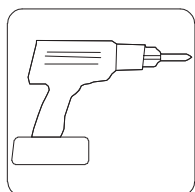



WARNING

- Must use ground nails, ropes, and expansions screws for whichever ground you install on for stability to avoid devastating injuries for people inside or nearby and property damage caused by a collapsing gazebo.
- Do not use this gazebo in high winds, heavy snow, or inclement weather. It is not designed to withstand strong gusts of wind, heavy snow accumulation, or other inclement weather. Must take precautions when the wind speed exceeds 25Mph, and clear snow when it accumulates more than 2 inches.
- Before use, thoroughly inspect the gazebo to make sure all bolts, nuts, and buckles have been completely tightened and securely fastened.
- Warranty does not cover damages, losses, or injuries resulting from improper installation, misuse, not using stability accessories mentioned above, non snow cleaning, failure to take precautionary measures, etc.

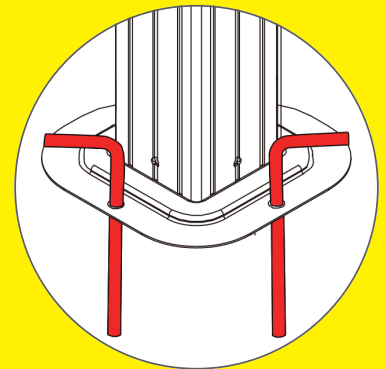
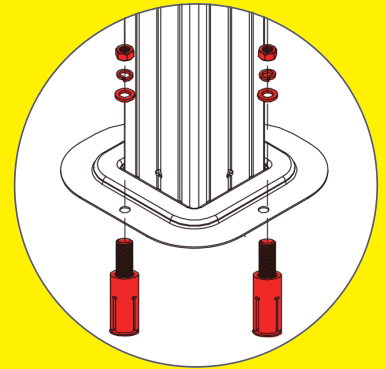



The following installation methods will provide better wind resistance performance, extend the product's lifespan, and help you maximize its value, delivering an even better user experience.

1

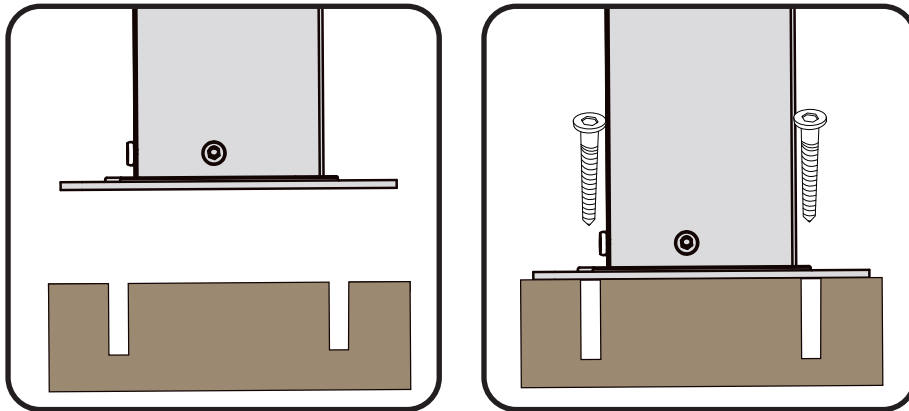



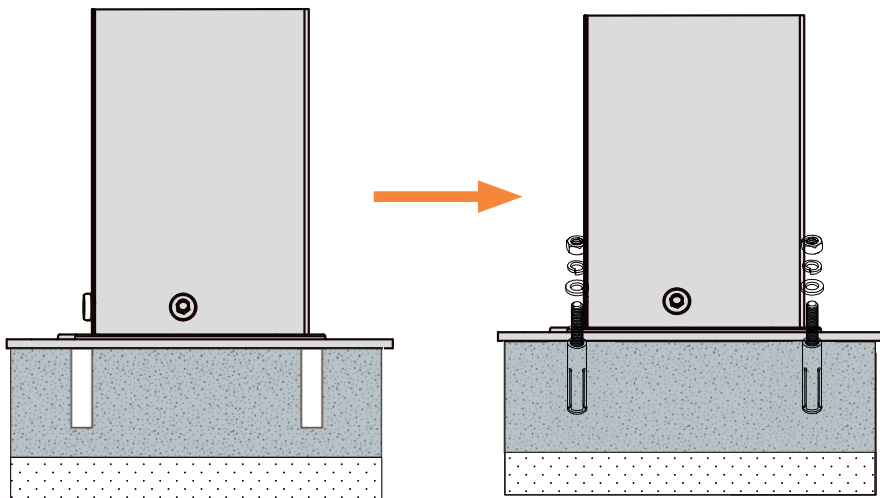



















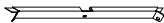

If the deck you are installing is made of hardwood and has a depth exceeding 40mm, you can use ST8*35mm screws to secure it in place. (This hardware is not included with the product, so you will need to purchase it separately.)

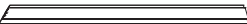

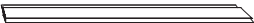



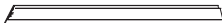



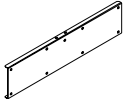
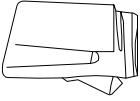
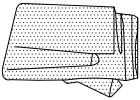

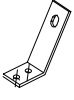
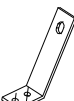

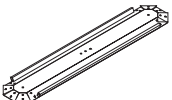
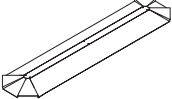
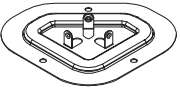

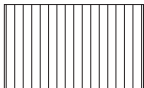

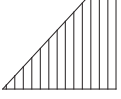
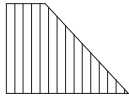
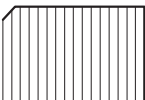
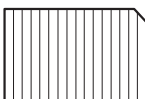
2









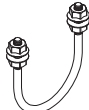
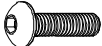

The best option is to fix it on a concrete surface. You can use the expansion bolts that are pre-configured with the product to secure it in place.

PARTS

Item no.	Reference Image	Qty.	Item no.	Reference Image	Qty.
A		X4	F		X2
B		X2	G		X4
B1		X2	G1		X4
B2		X2	G2		X4
B3		X2	G3		X2
Ea		X4	G4		X2
Eb		X4	G5		X2
E1		X6	G6		X2
E2		X6	G7		X2
F1		X4	K		X4
F2		X4	K1		X4
F3		X4	N		X12
F4		X4	N1		X12

Item no.	Reference Image	Qty.
P		X4
T		X4
T1		X4
U		X128
W2		X6
W3		X4
V		X4
L		X1
M		X1
J		X4
H		X4
H1		X4
Q		X4

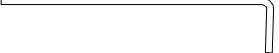
Item no.	Reference Image	Qty.
Q1		X4
Q2		X4
Q3		X4
Q4		X4
Q5		X4
Q6		X4
R1		X4
R2		X4
R3		X2
1	 M6X16mm	X136
3	 M6X25mm	X1
4	 ST4.8X12mm	X24
8	 M6X15mm	X16

Item no.	Reference Image	Qty.	Item no.	Reference Image	Qty.
9	 10X50mm	X12	15		X1
10	 M5X12mm	X24	16		X30
11		X2	17		X4
12	 S4	X1	18		X4
13	 S5 S6	X1	19		X6
14		X12	D		X6

ASSEMBLY

1

X4



A 4pcs

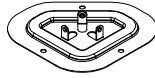

J 4pcs



1 12pcs

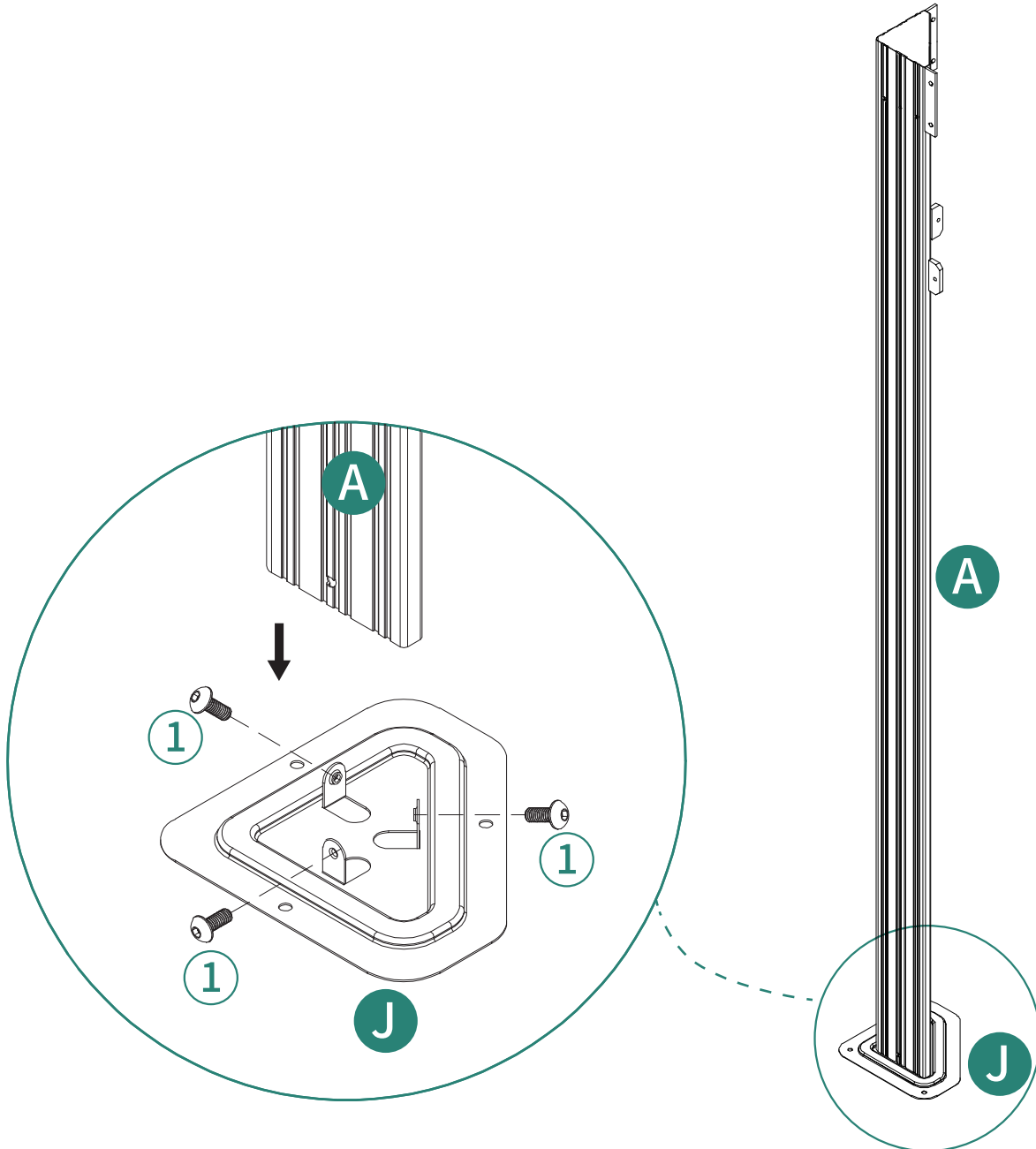

2

X2

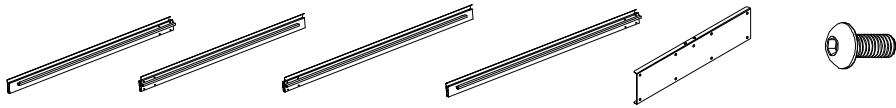

ⓑ 2pcs ⓑ1 2pcs ⓑ2 2pcs ⓑ3 2pcs ⓐ 4pcs ① 32pcs

When connecting B and B1 via P, B2 and B3 via P, make sure that 1 holes on part P (as shown in the picture) should be facing upwards. Do not install it upside down.

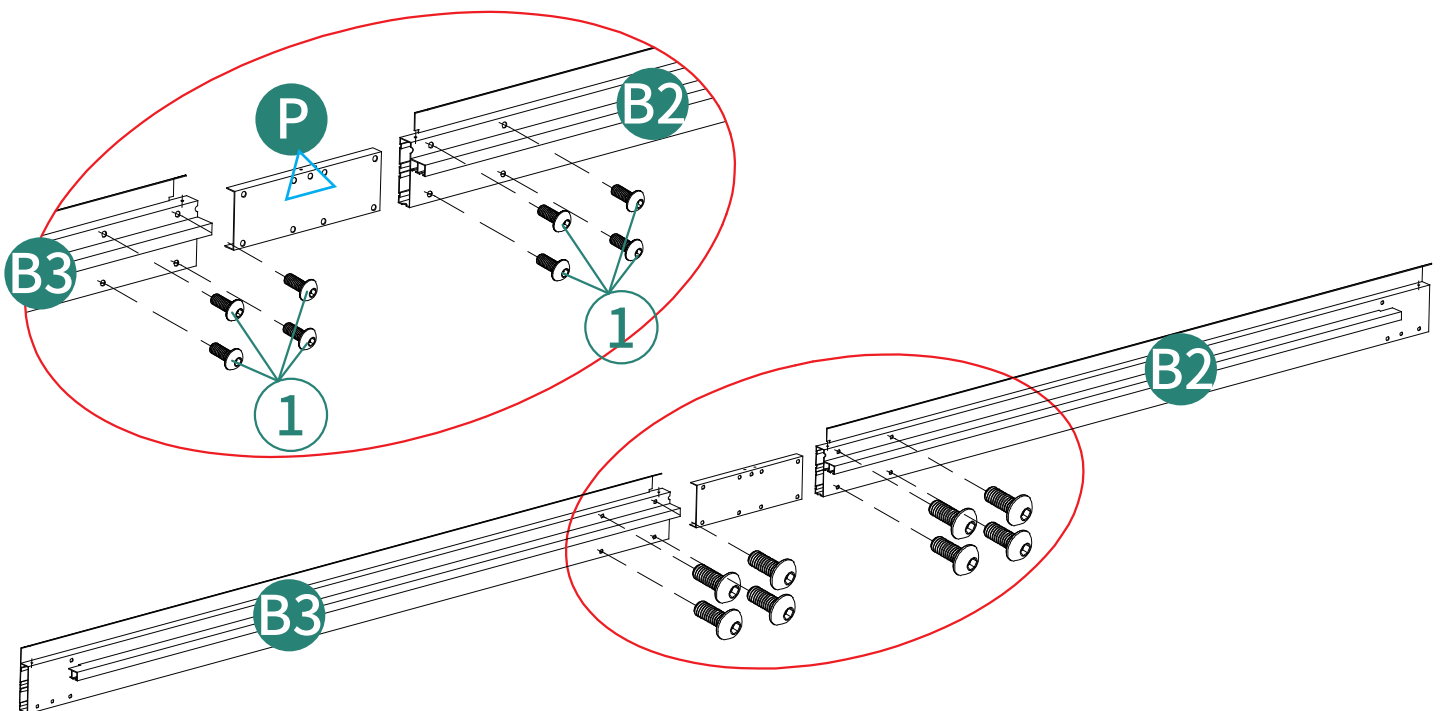
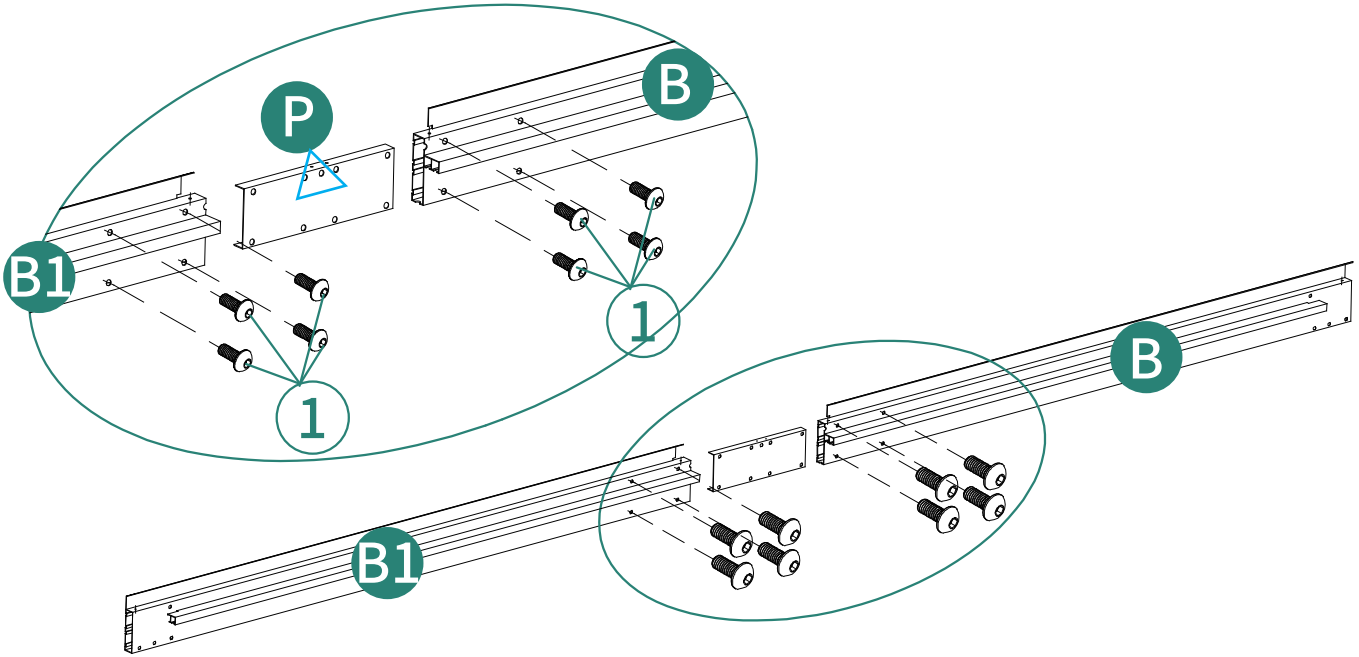

3



① 16pcs ⑧ 16pcs

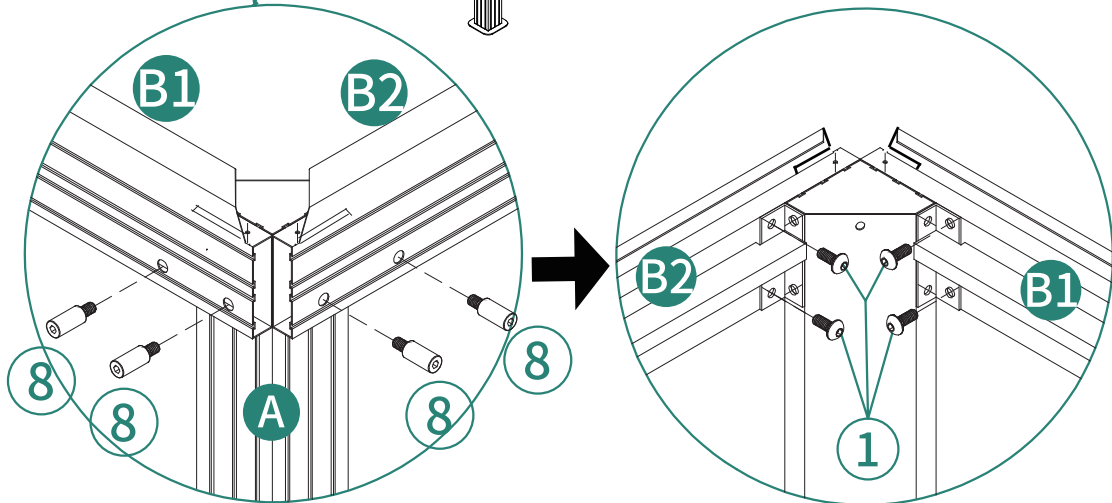
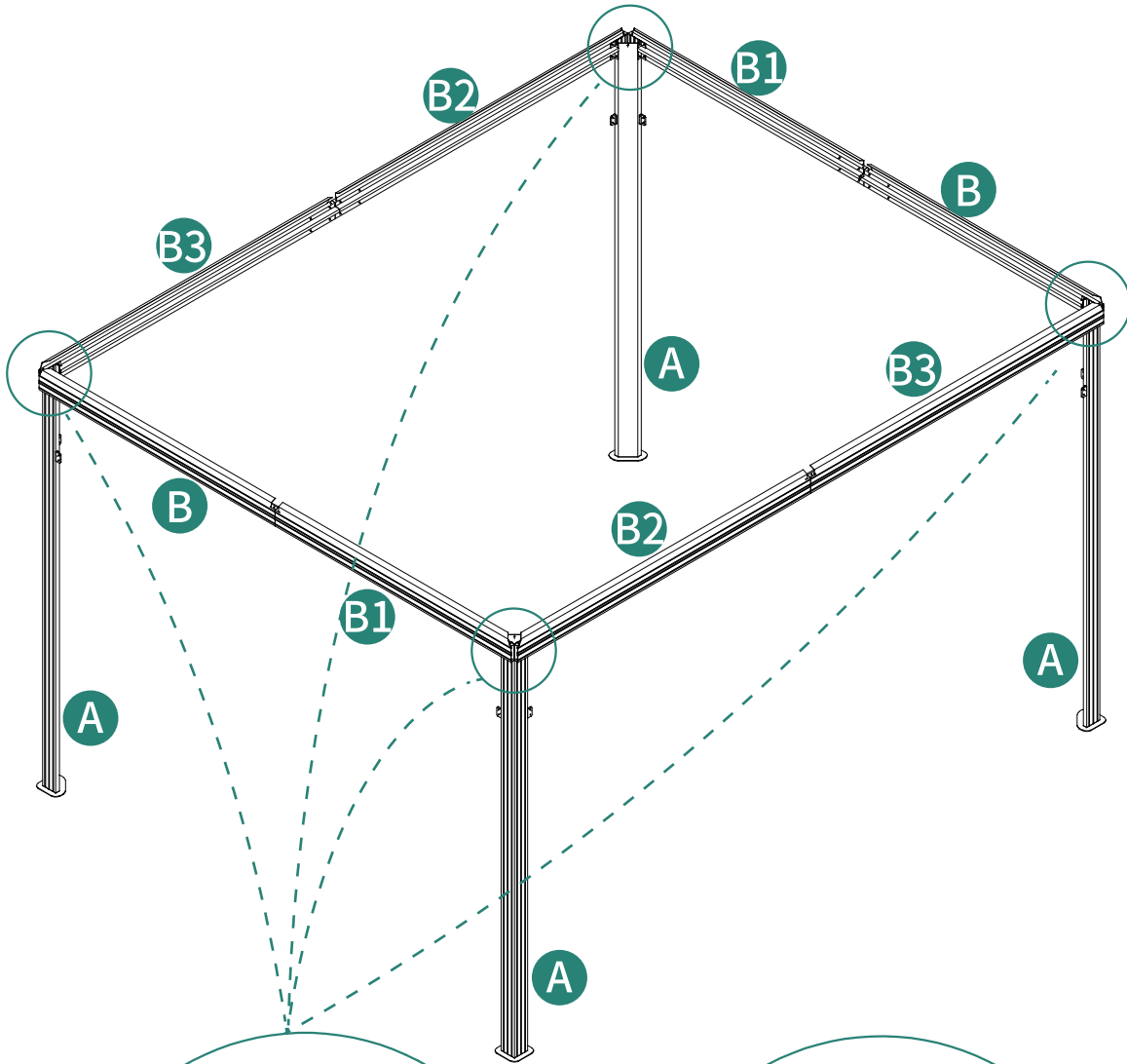

4



H 4pcs



H1 4pcs



1 16pcs

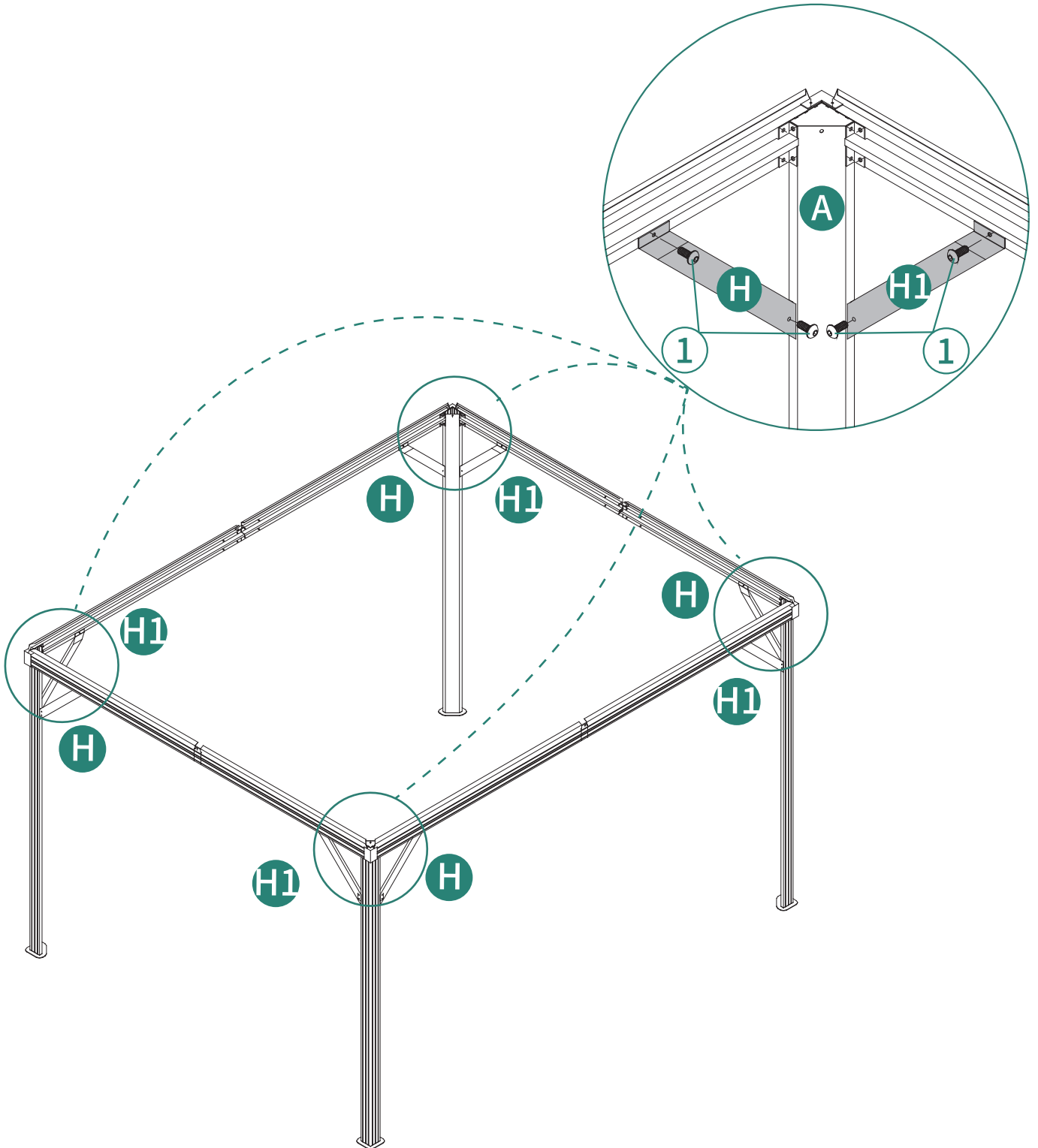

5

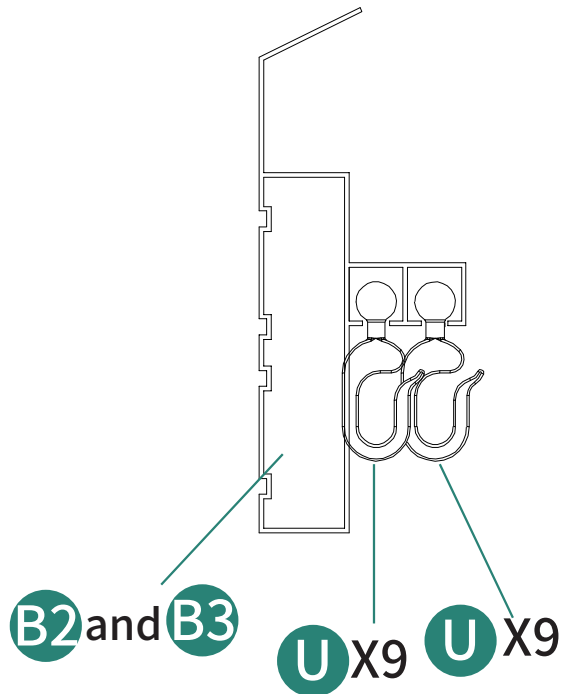
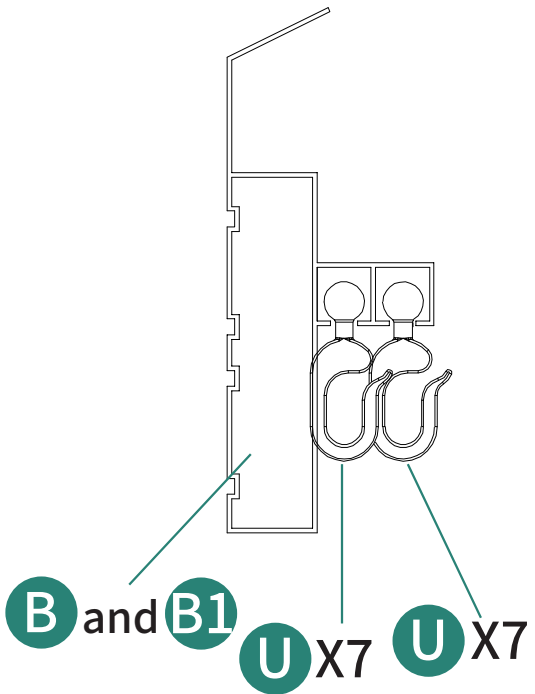
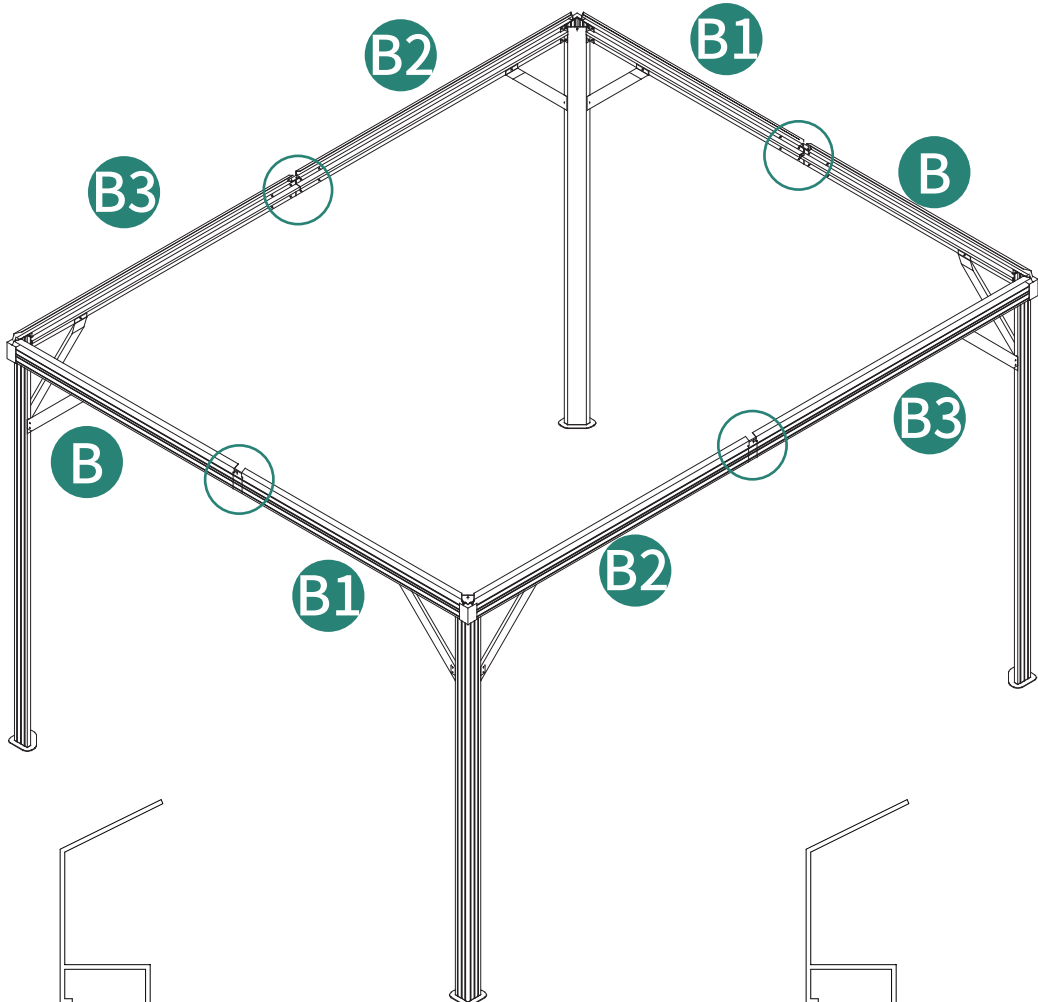

U 128pcs



6

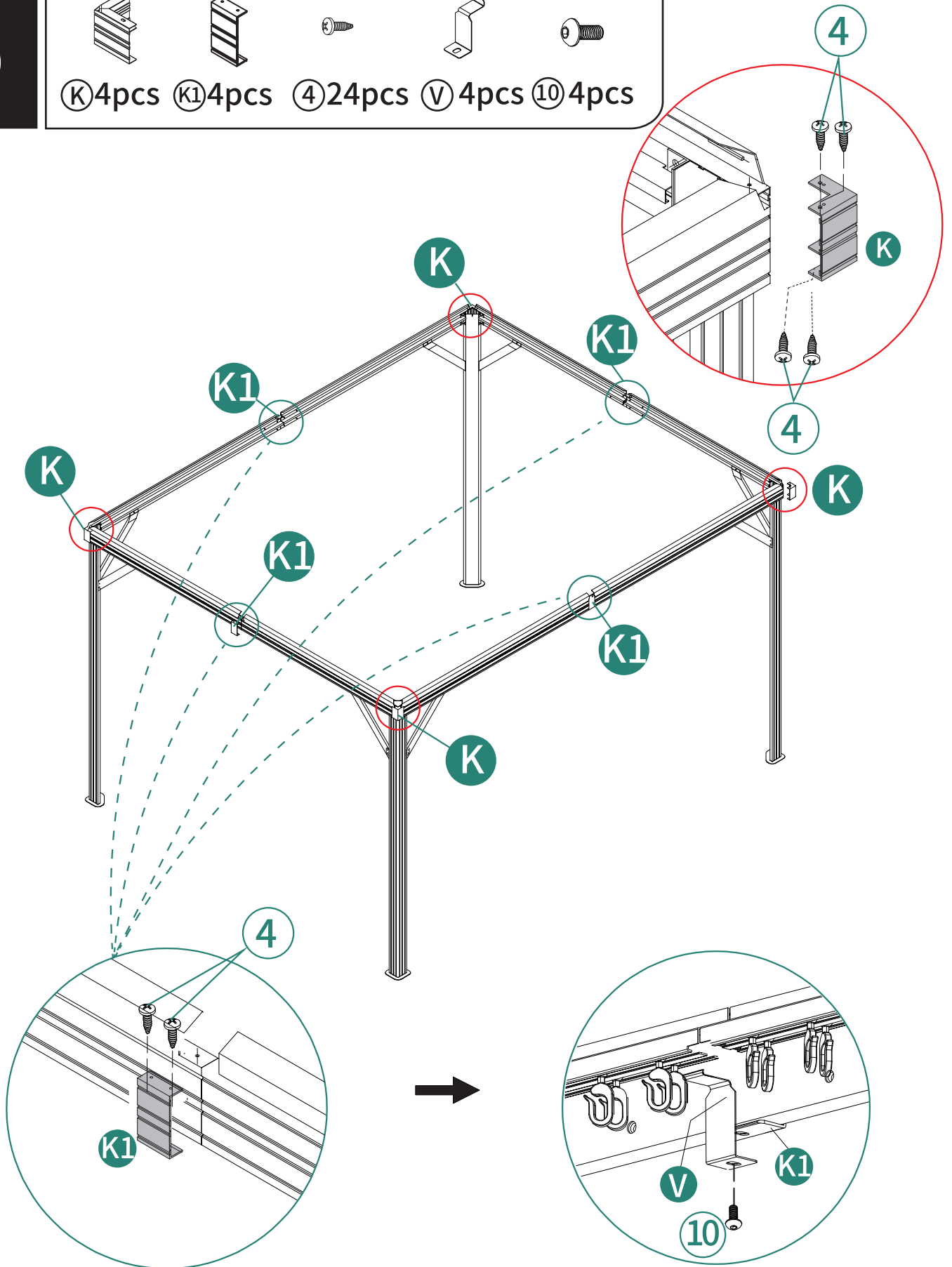

Ⓚ 4pcs Ⓚ1 4pcs ④ 24pcs Ⓥ 4pcs ⑩ 4pcs



7

X4

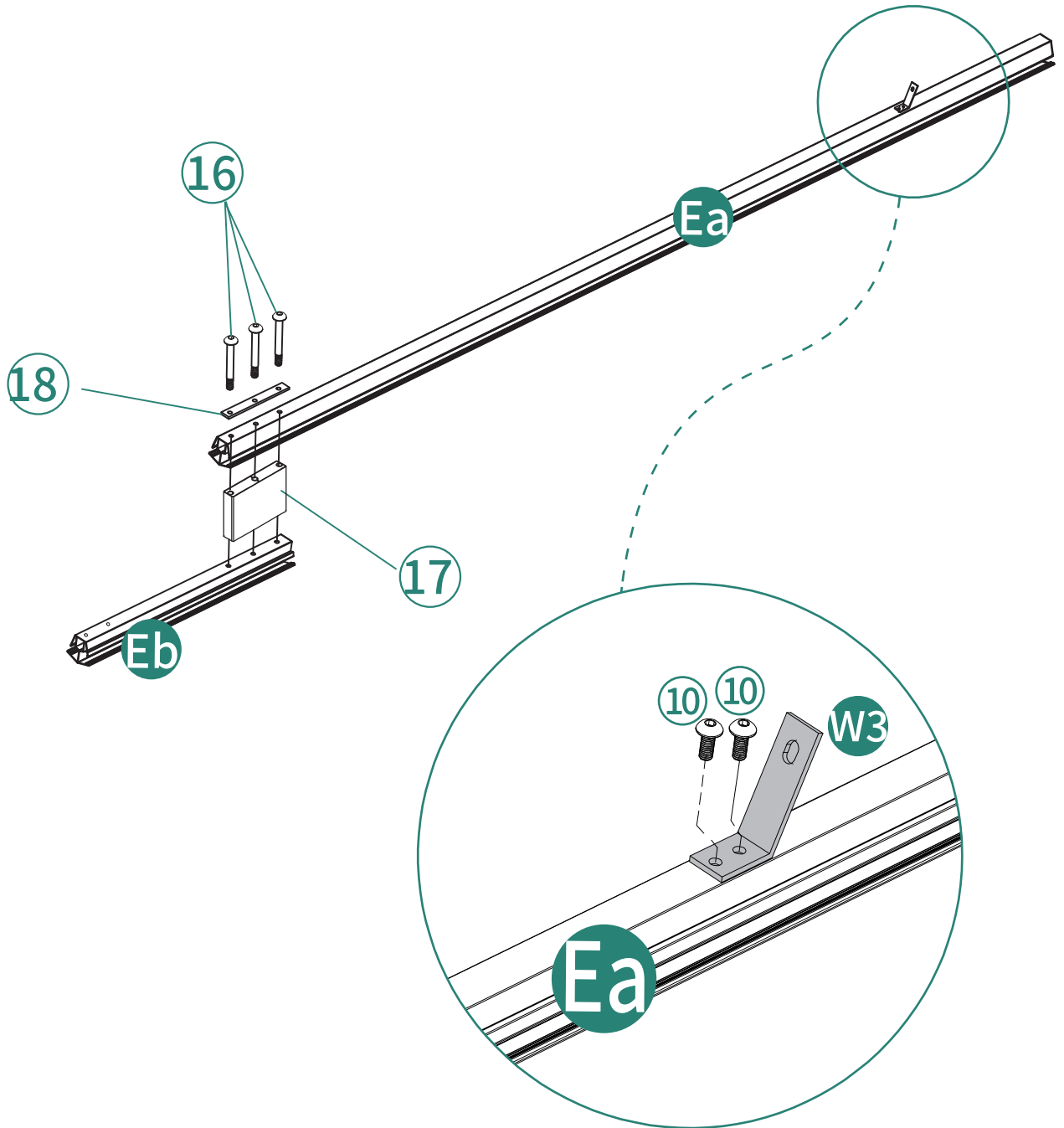
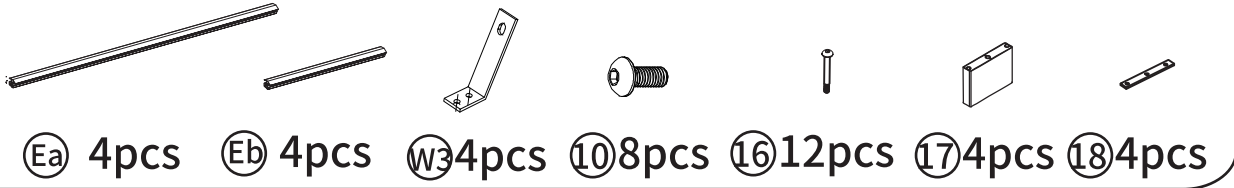

8

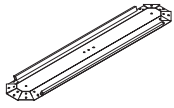

L 1pc



1 8pcs

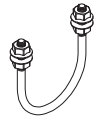

15 1pc

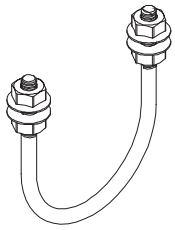

15



1

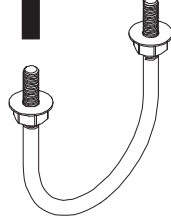
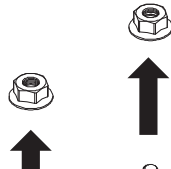

2

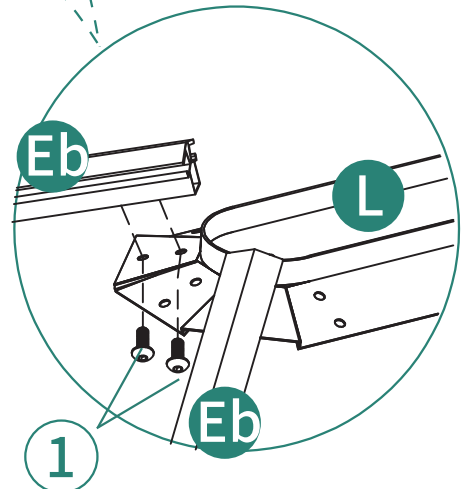
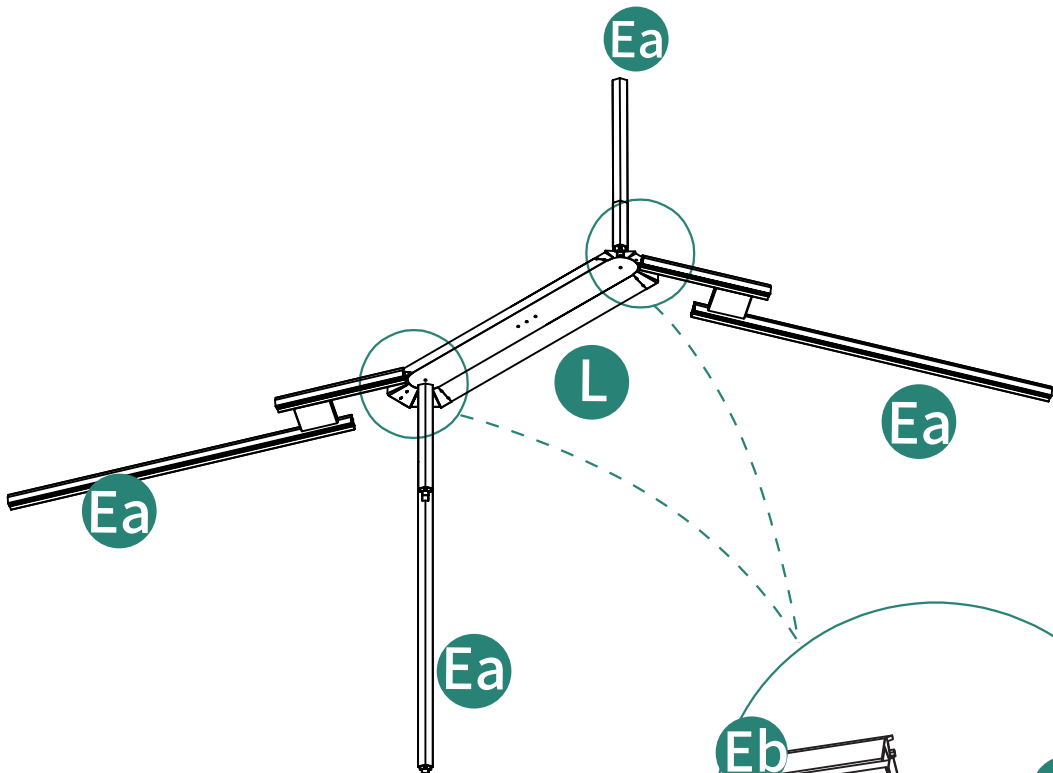
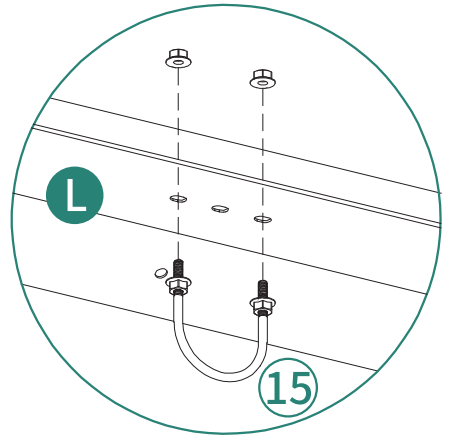





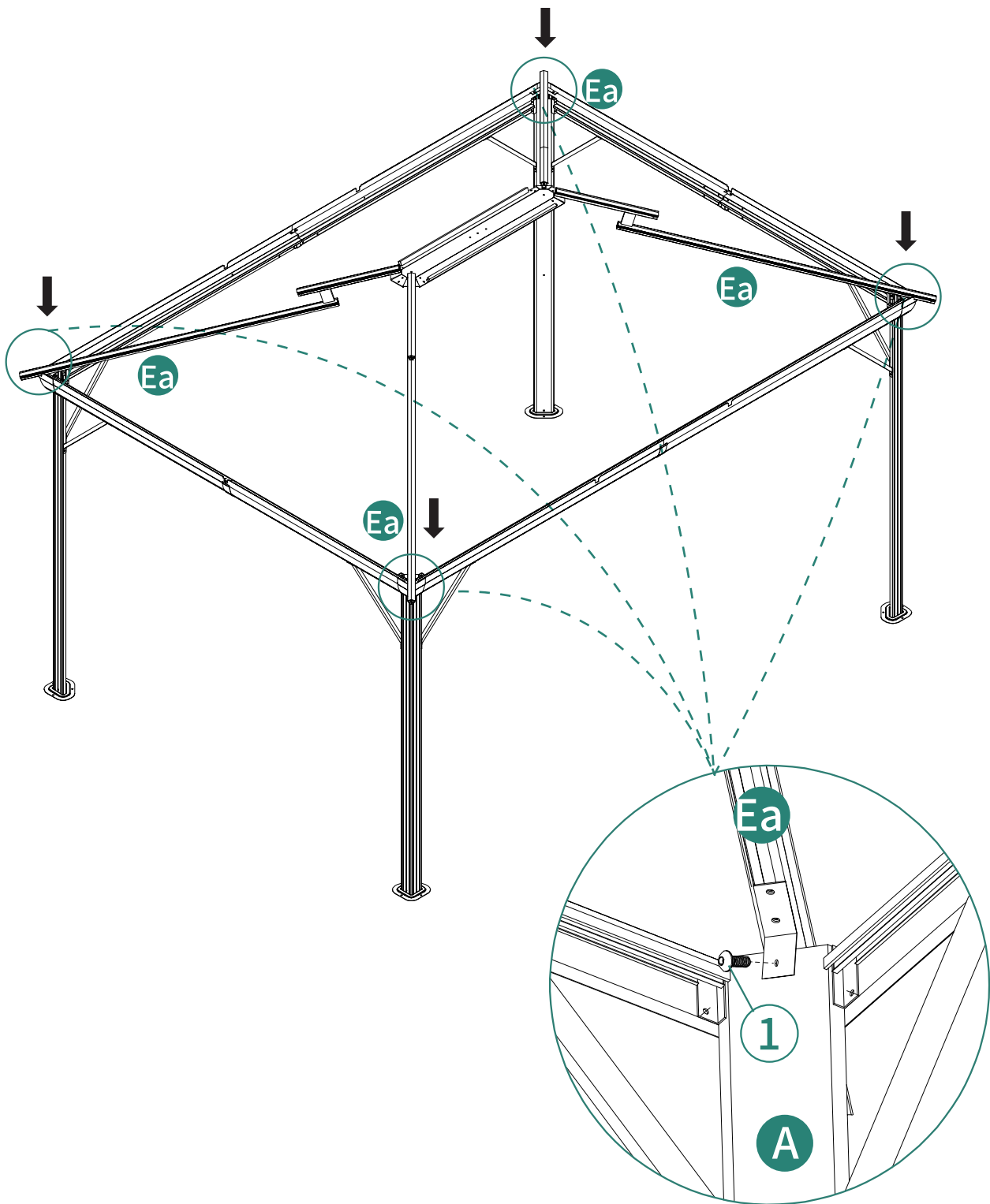

9



① 4pcs



10 X6

-  ①E1 6pcs
-  ②E2 6pcs
-  ③W2 6pcs
-  ④10 12pcs
-  ⑤16 18pcs
-  ⑥D 6pcs
-  ⑦19 6pcs

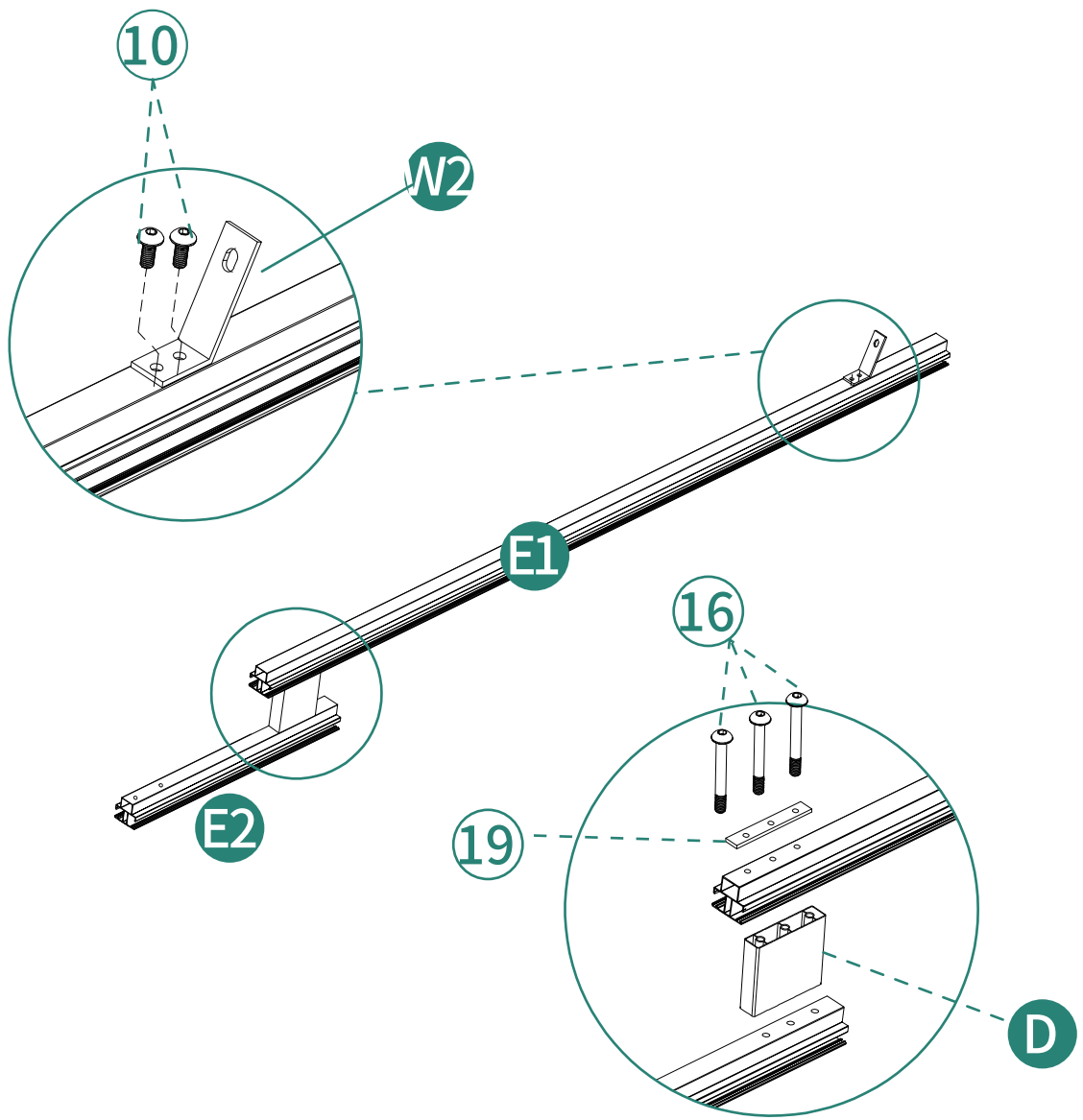

11



① 18pcs

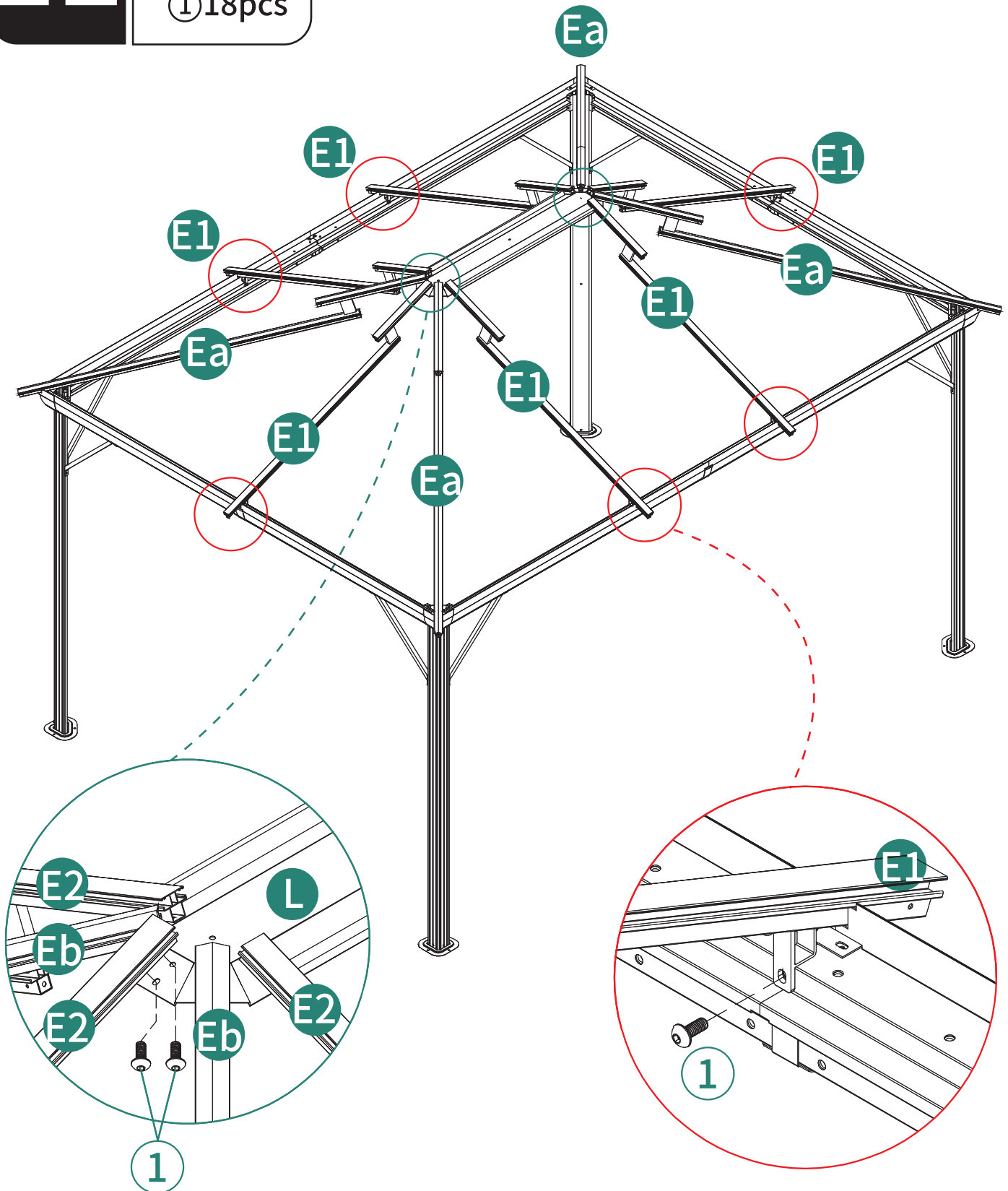

12

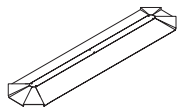

Ⓜ 1pc



Ⓜ 11 2pcs



Ⓜ 3 1pc

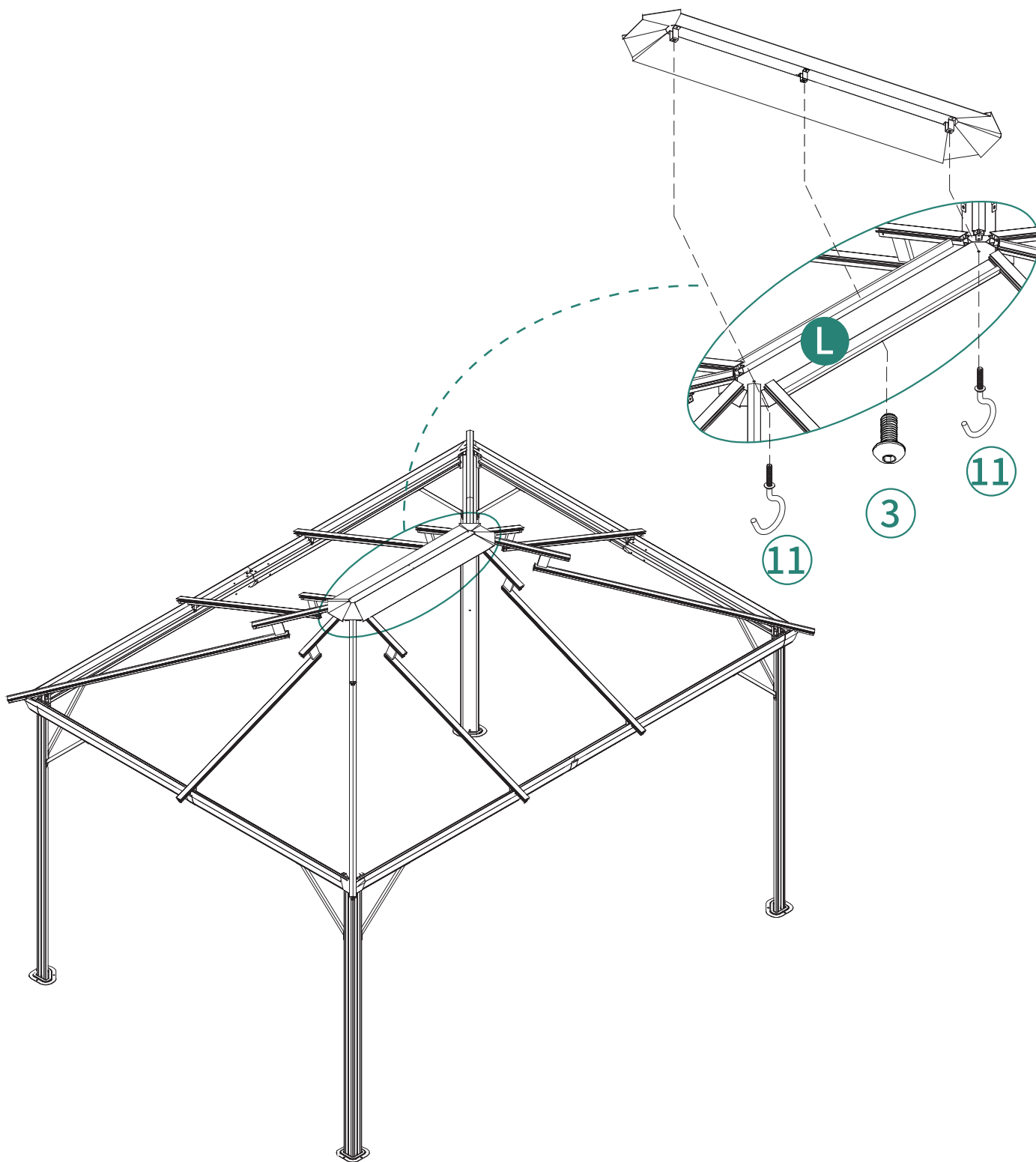

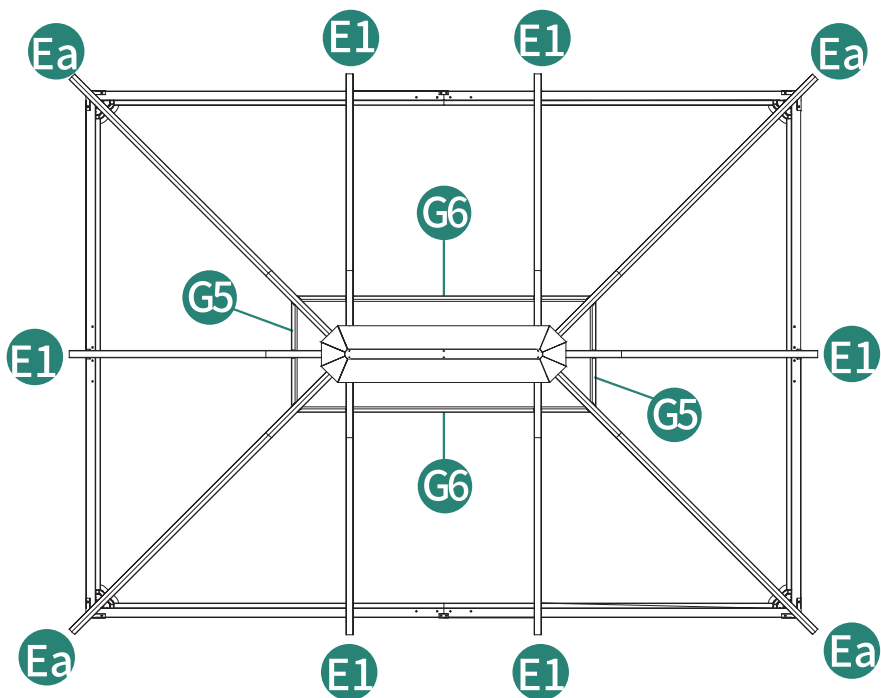
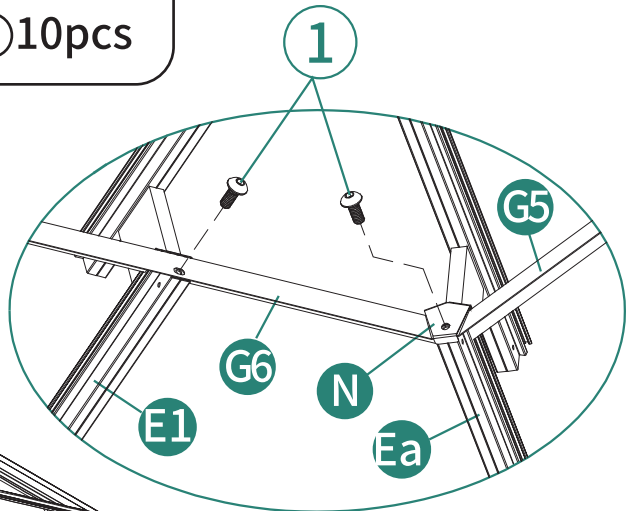
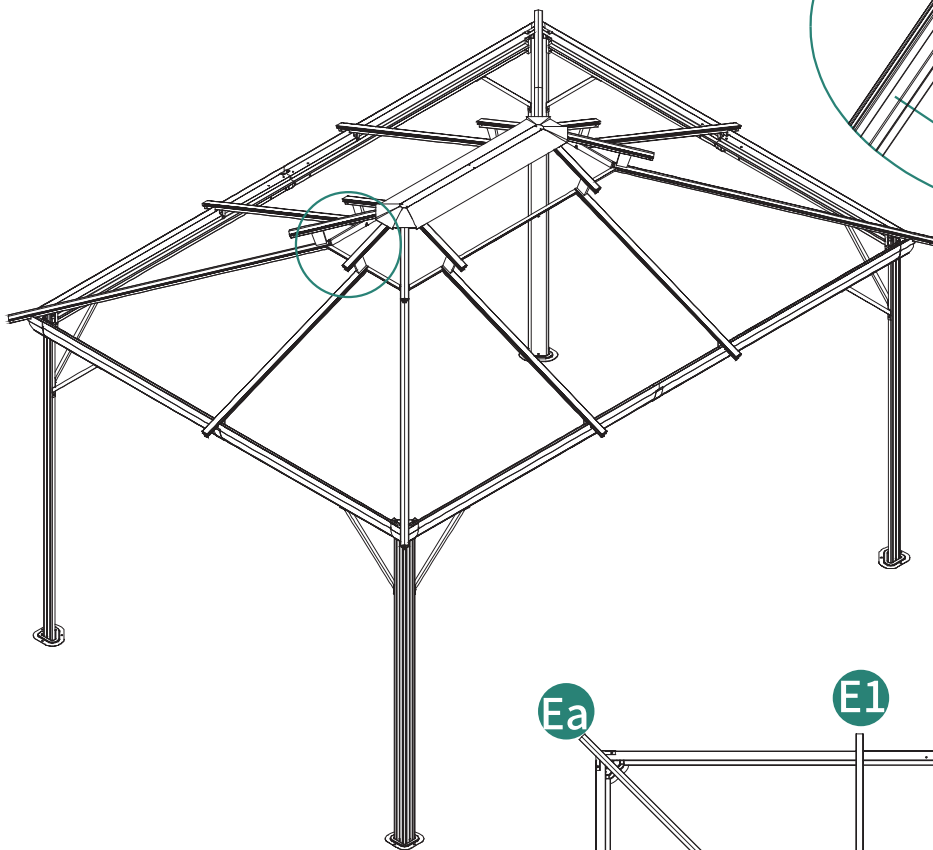
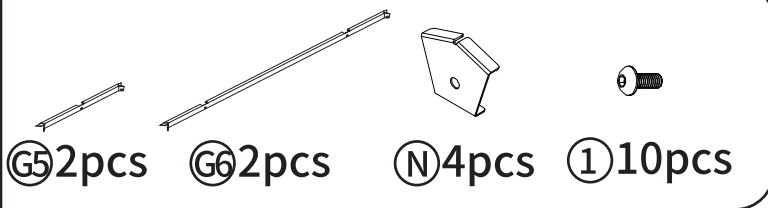

13





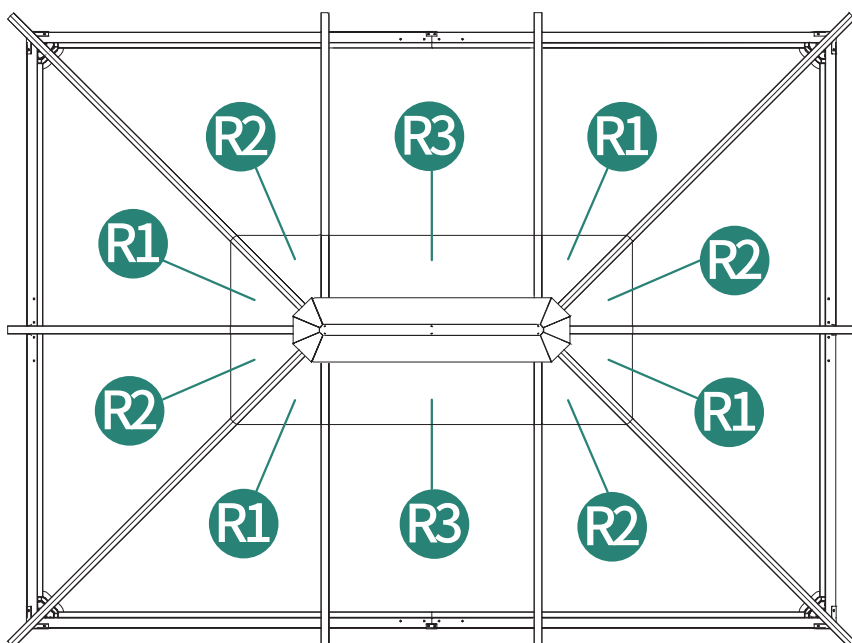
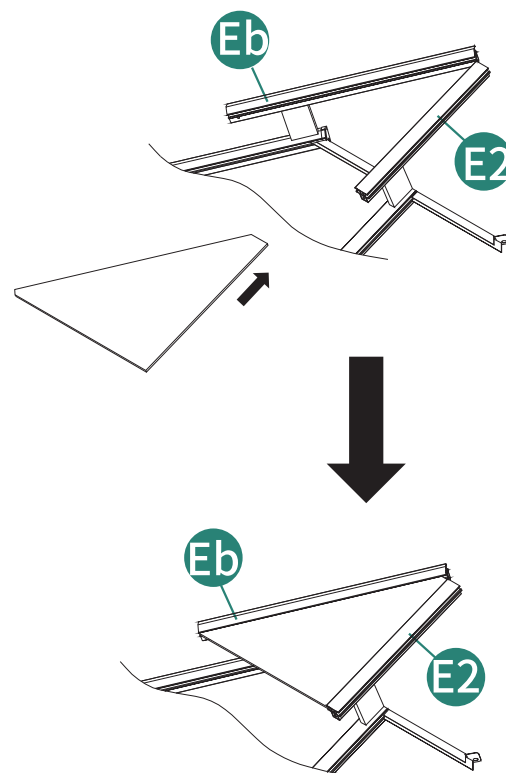
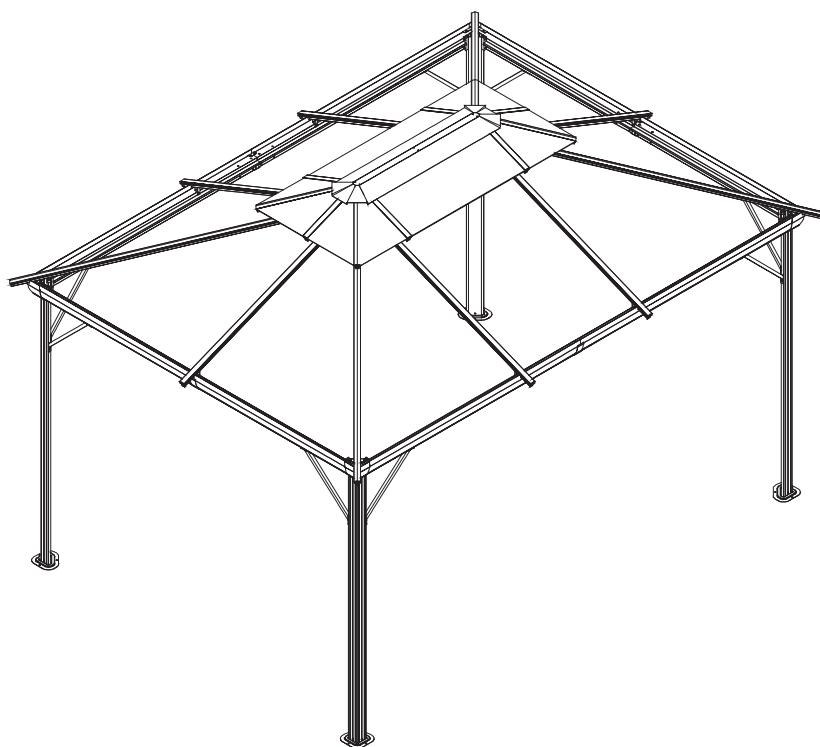



14

 **R1** 4pcs  **R2** 4pcs  **R3** 2pcs



 Before installing Parts R1/R2/R3, remove protective films (with side marks) on both the front and back sides. After removal, there will be no mark and minimal difference between the sides. Therefore, pay close attention to directions before removal.

15

-  G3 2 pcs
-  G4 2 pcs
-  G7 2 pcs
-  G2 2 pcs
-  N 4 pcs
-  1 10 pcs
-  N1 6 pcs

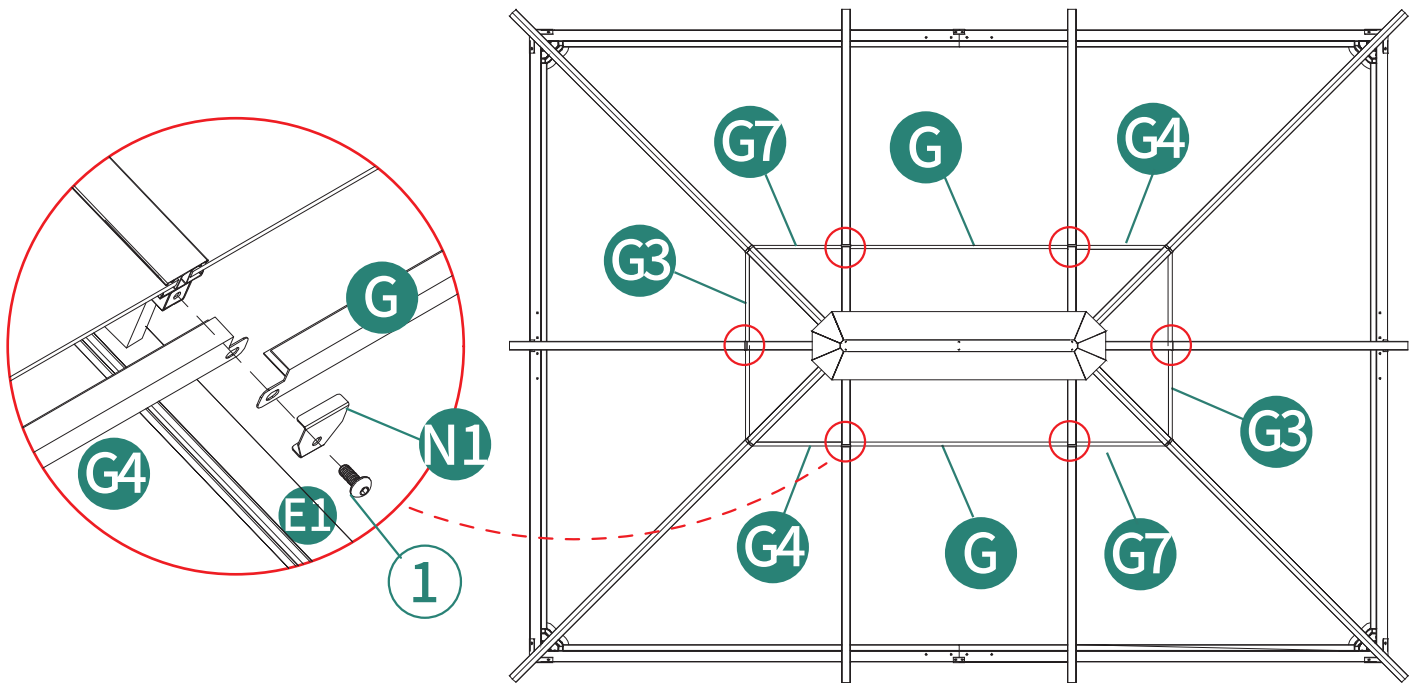
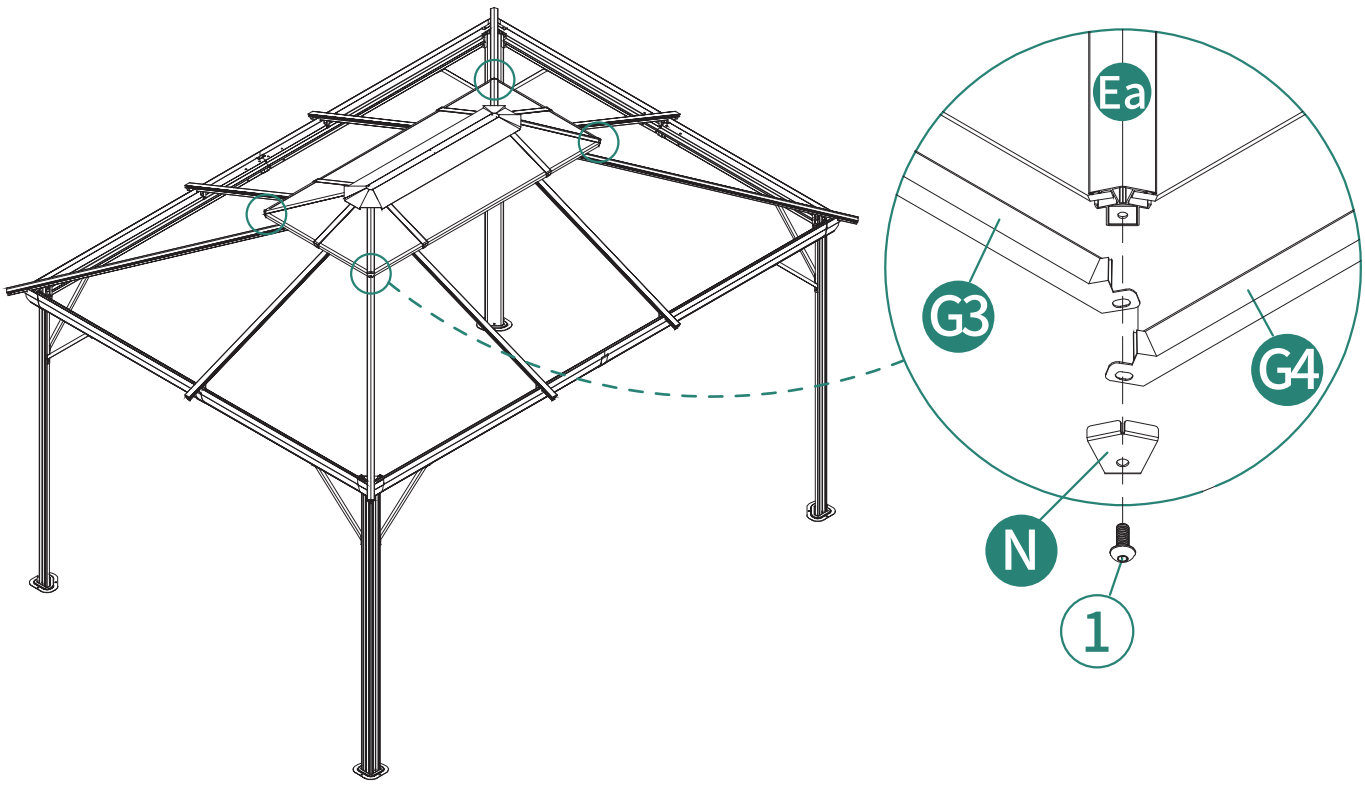

16

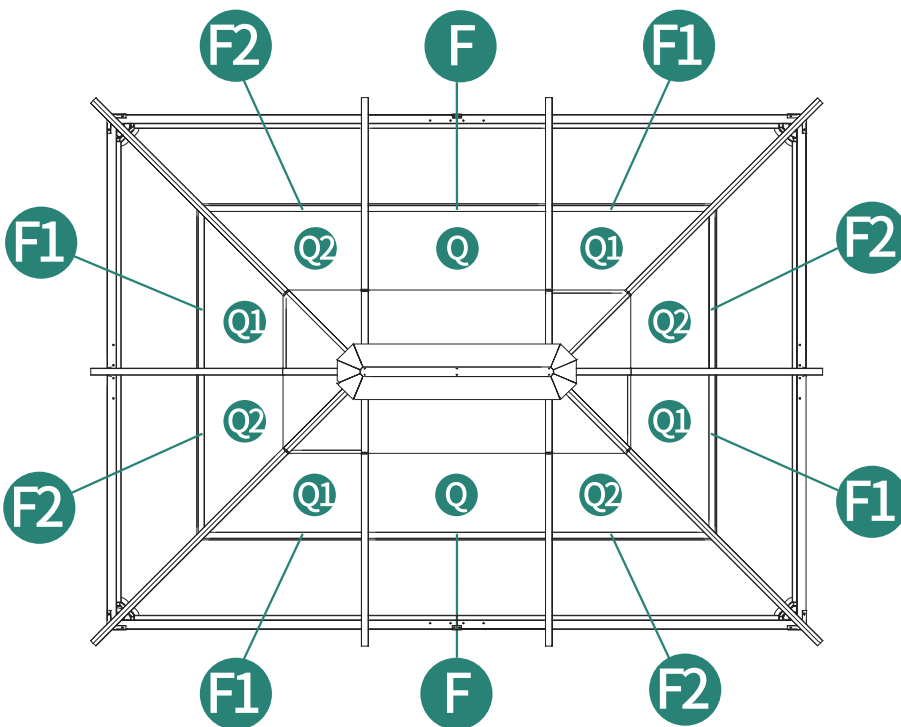
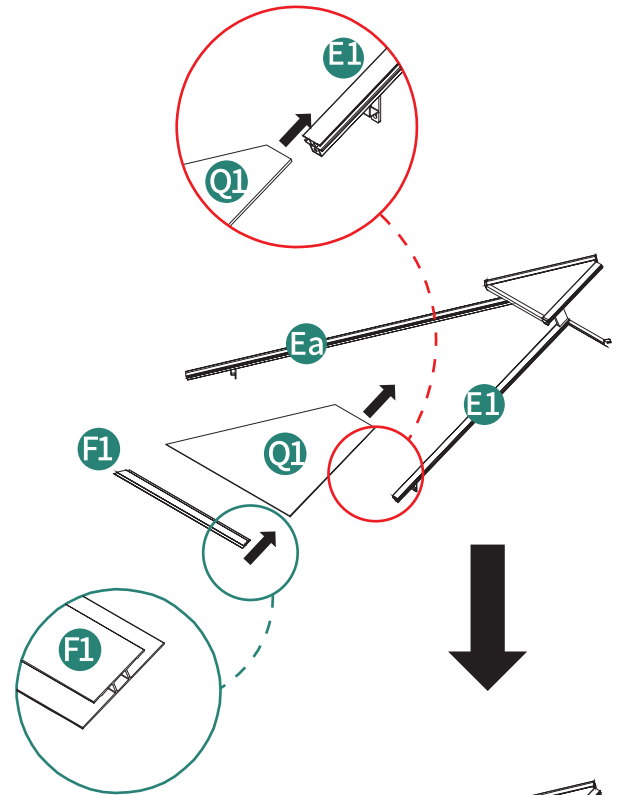
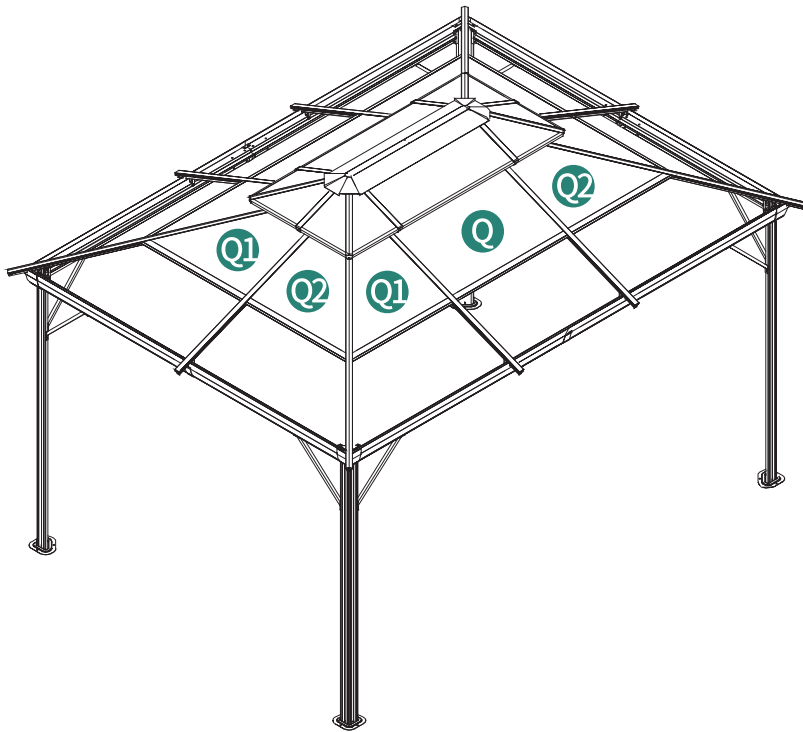
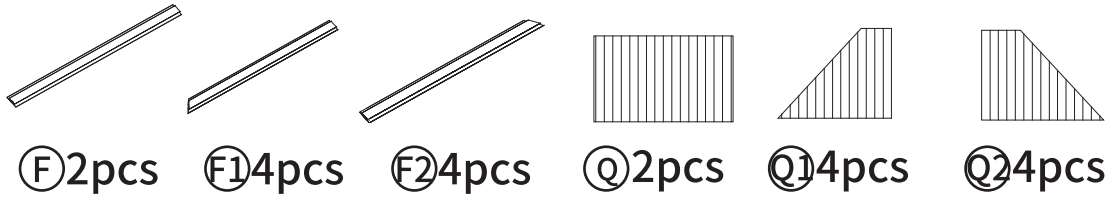

⚠ Before installing Parts Q/Q1/Q2, remove protective films (with side marks) on both the front and back sides. After removal, there will be no mark and minimal difference between the sides. Therefore, pay close attention to directions before removal.

17

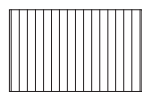

Q 2pcs

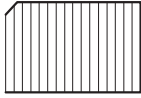

Q3 4pcs

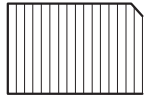

Q4 4pcs



Q5 4pcs



Q6 4pcs

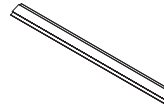

F3 4pcs

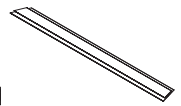



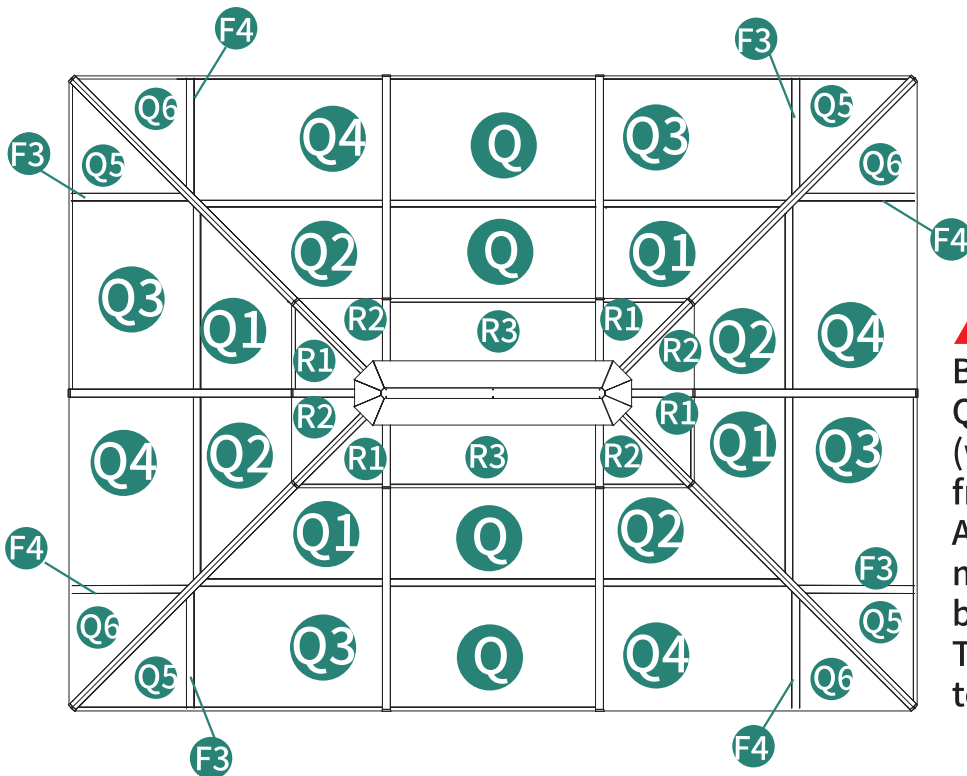
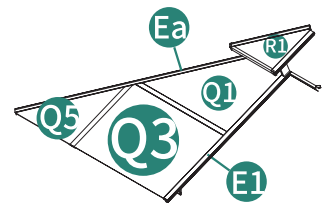
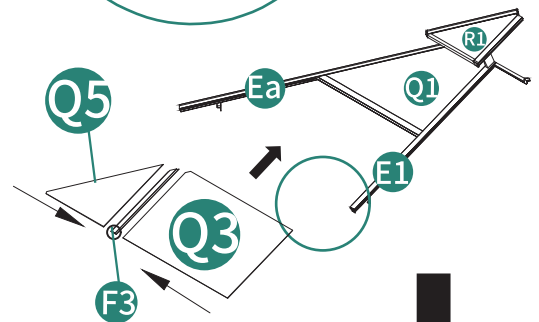
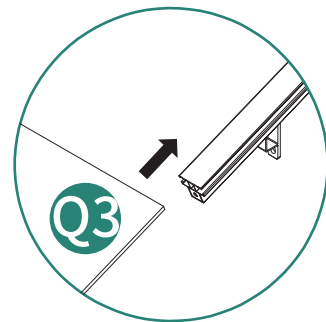
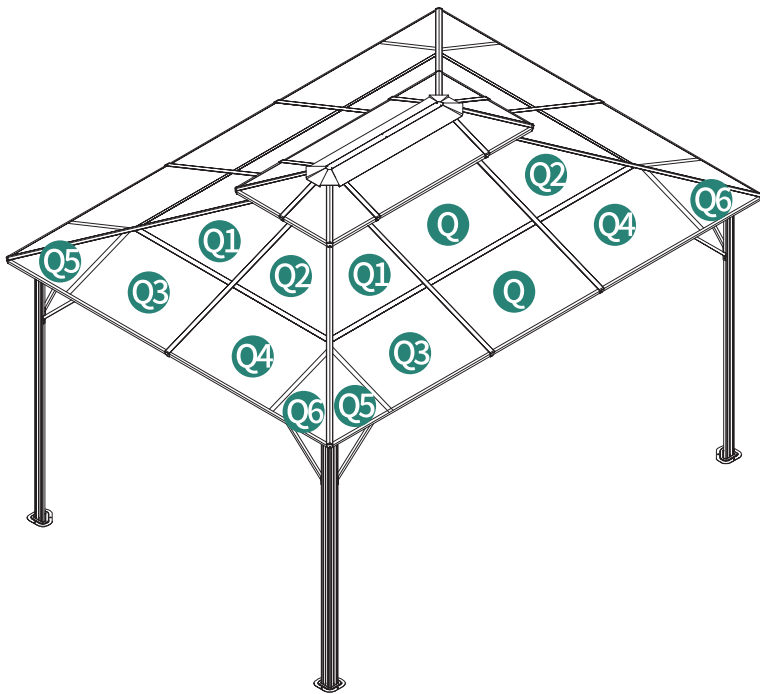

F4 4pcs

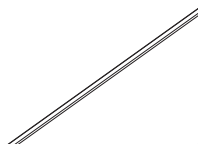
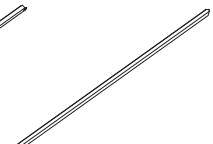

Before installing Parts Q/Q3/Q4, Q5/Q6 remove protective films (with side marks) on both the front and back sides. After removal, there will be no mark and minimal difference between the sides. Therefore, pay close attention to directions before removal.

18

-  G2 2pcs
-  G1 4pcs
-  G2 4pcs
-  N 4pcs
-  N1 6pcs
-  1 10pcs

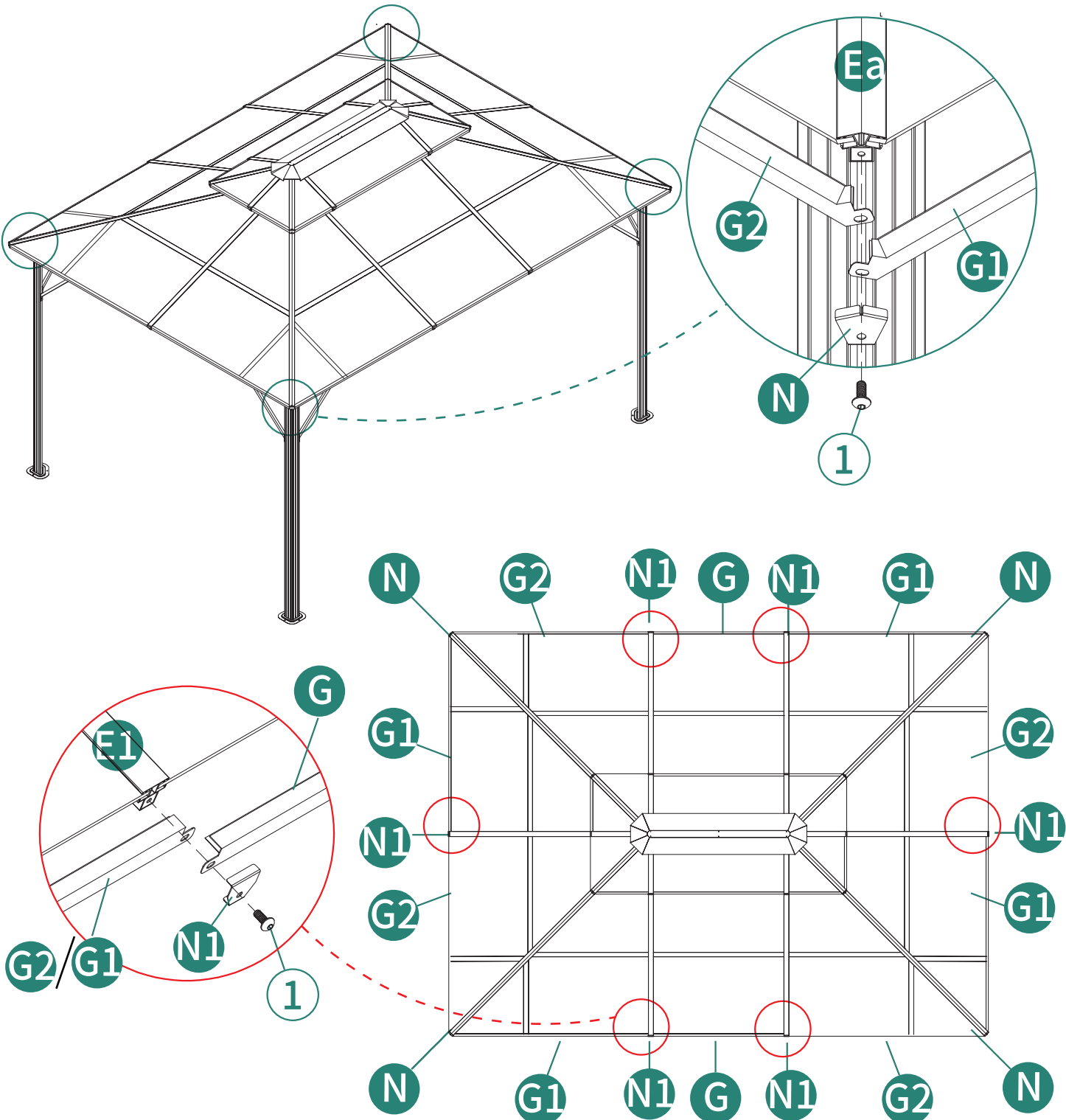

19

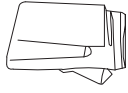

Ⓣ4pcs

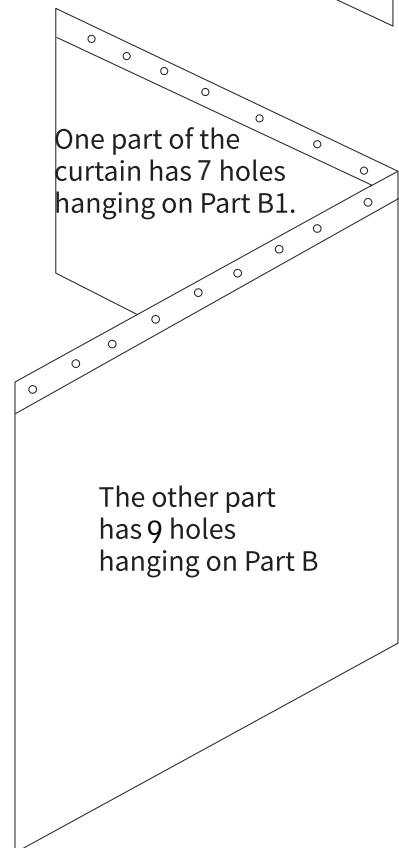
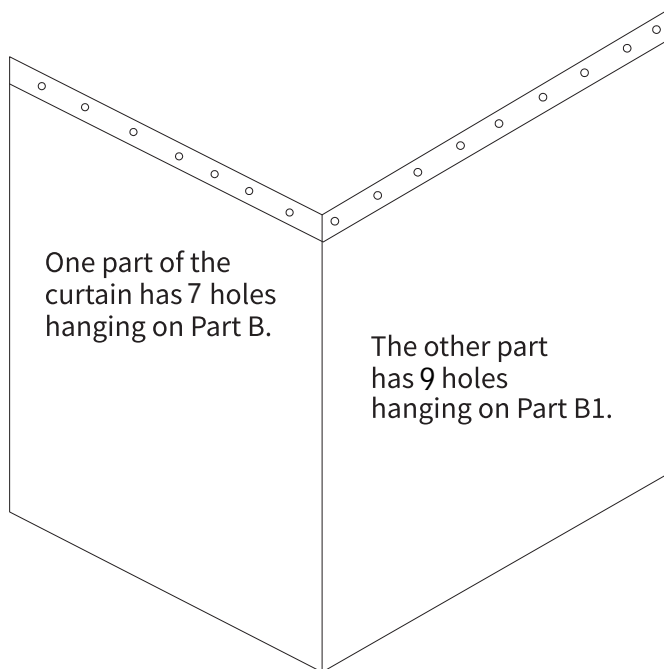
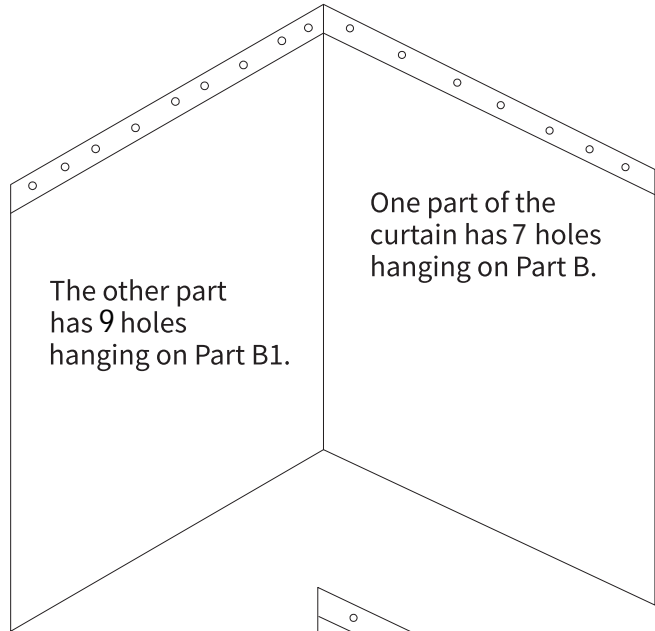
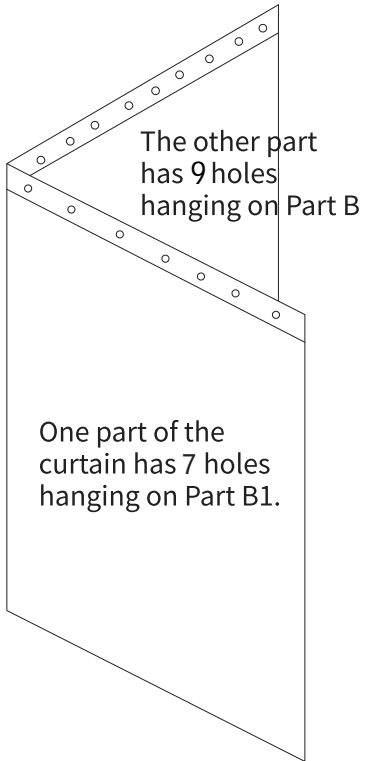

20

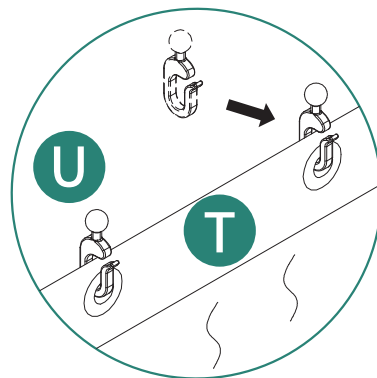
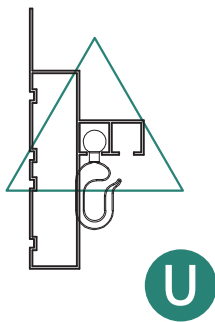
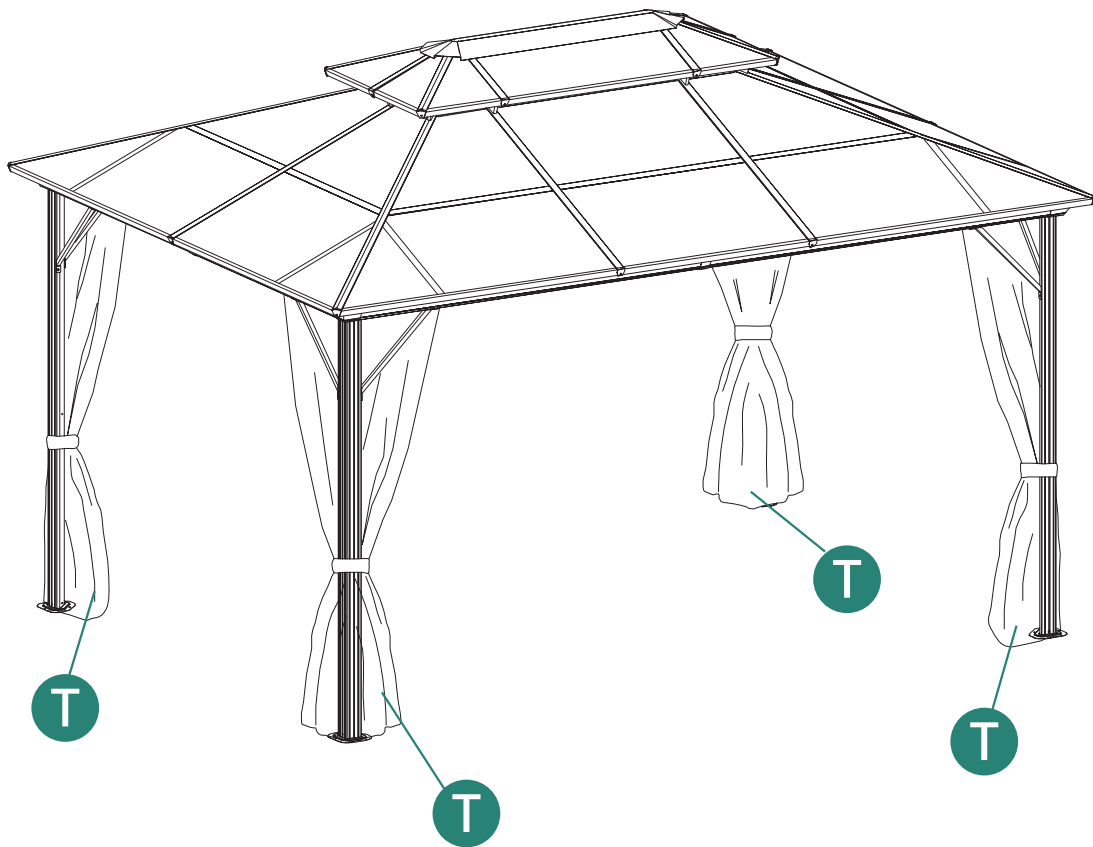

Pay attention to the sidewall curtain's installation position.

21

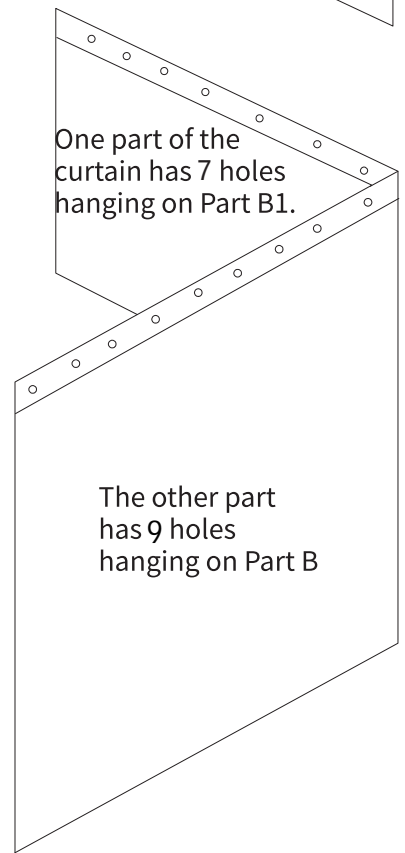
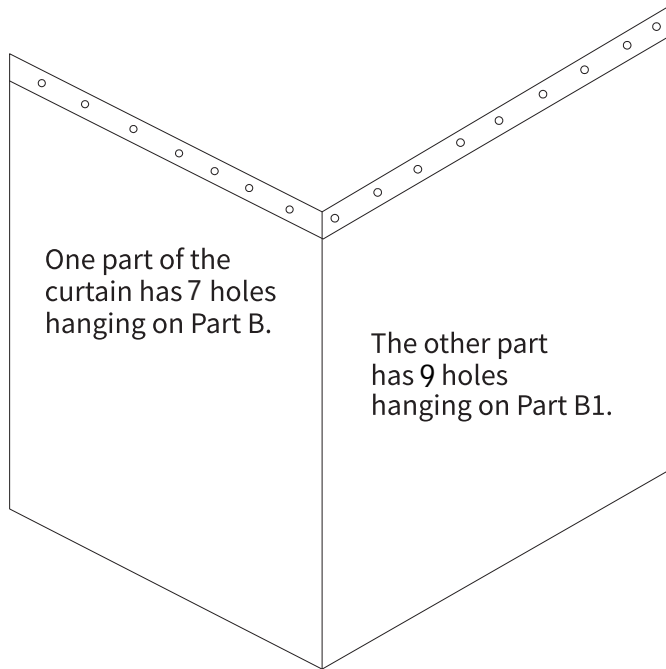
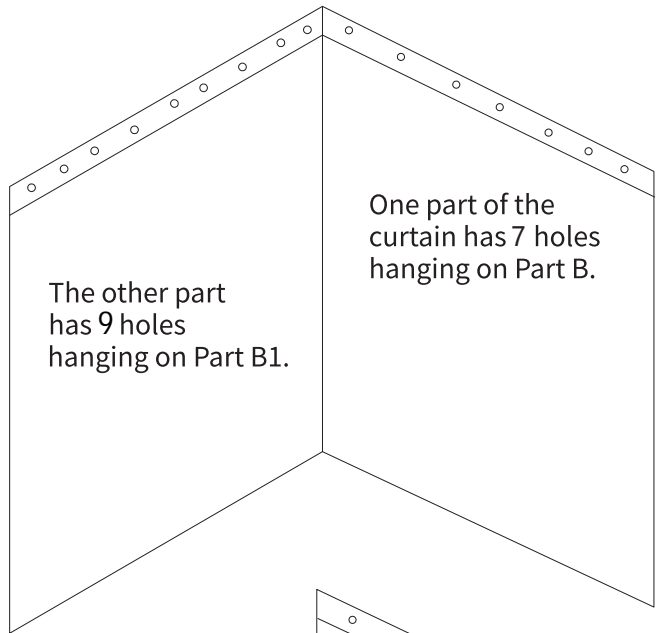
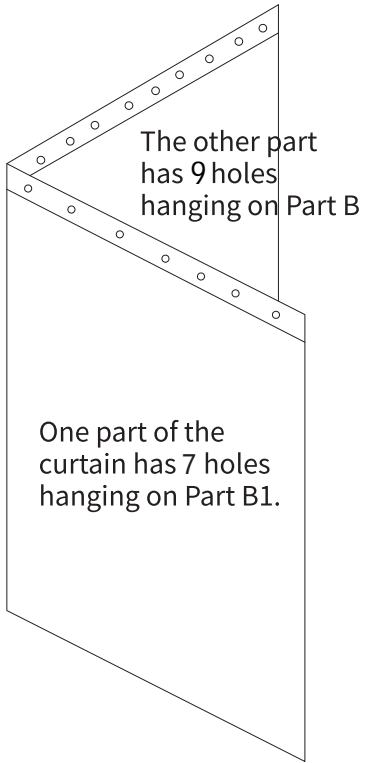
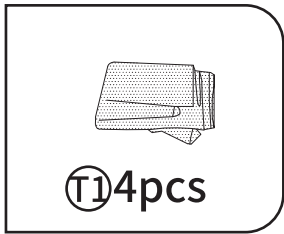

22

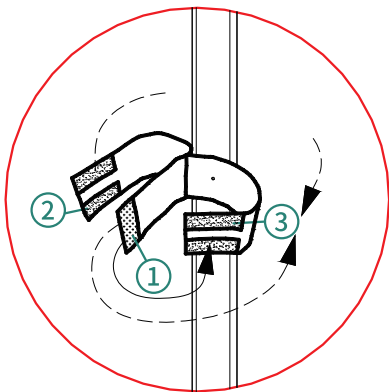
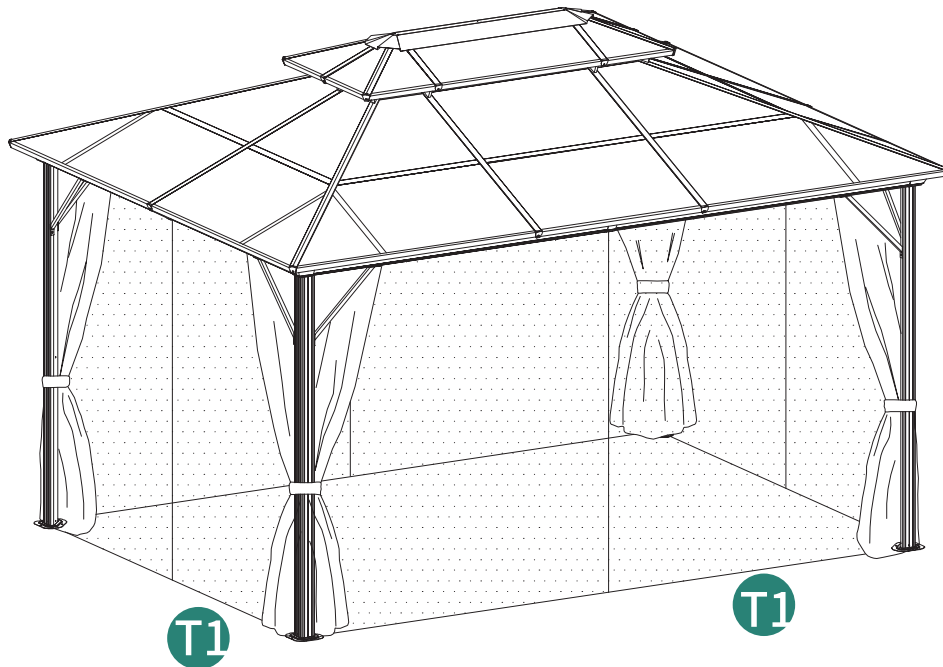

Note:

Attach 1 to 2 to secure parts S (netting) and T (curtains) together.

Attach 1 to 3 to secure the back curtain (T).

Attach 1 to 3 to secure the front netting (T1).

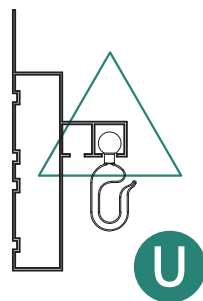

Pay attention to the sidewall netting's installation position.

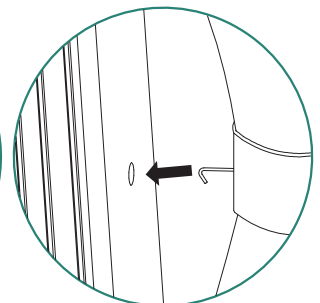
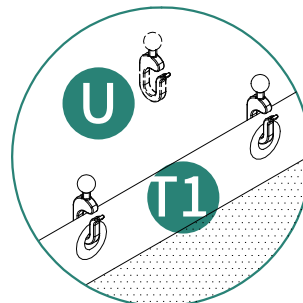

Hang the hook attached to the netting on Part A.

23

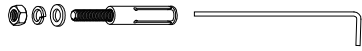

⑨ 12pcs ⑭ 12pcs

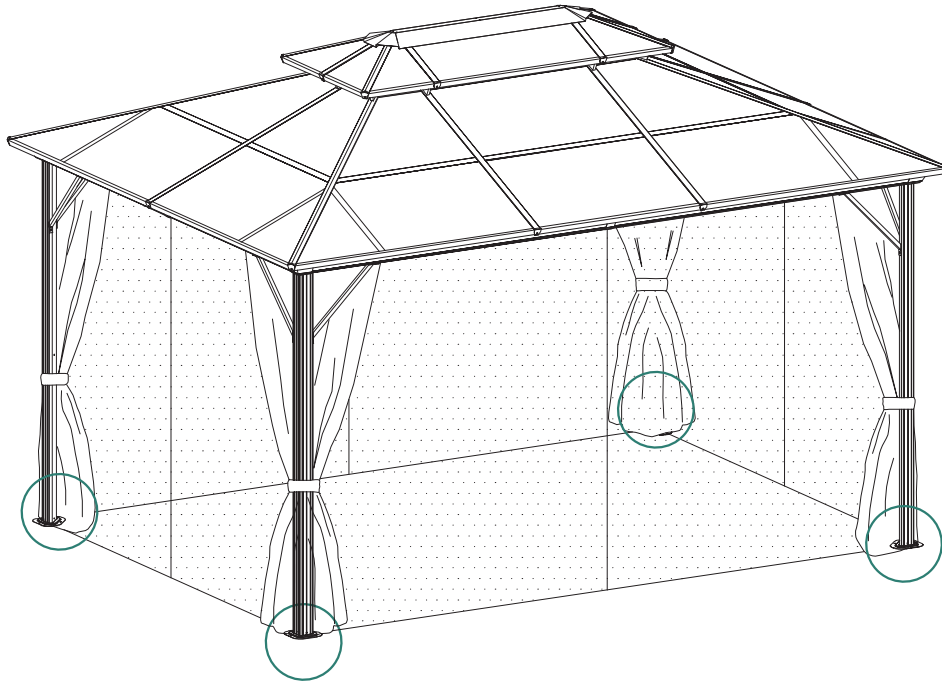

1. The product must be installed on a solid base, such as cement or a floor, to prevent damage from strong winds and potential property or health risks.

2. If the product cannot be securely fixed, you must detach and store it properly before heavy winds occur.

3. The manufacturer will not be liable for any losses or damages if these instructions and recommendations are not followed.

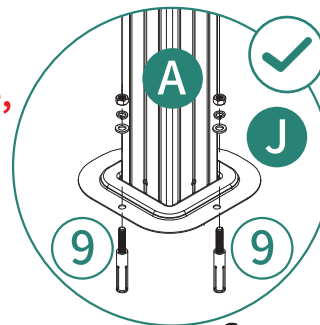

Cement surfaces

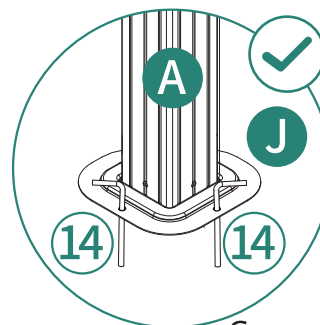
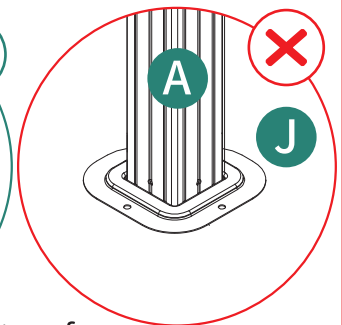

Grassy surfaces

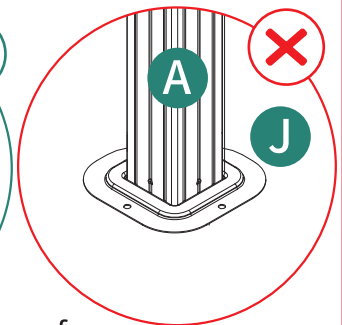

24

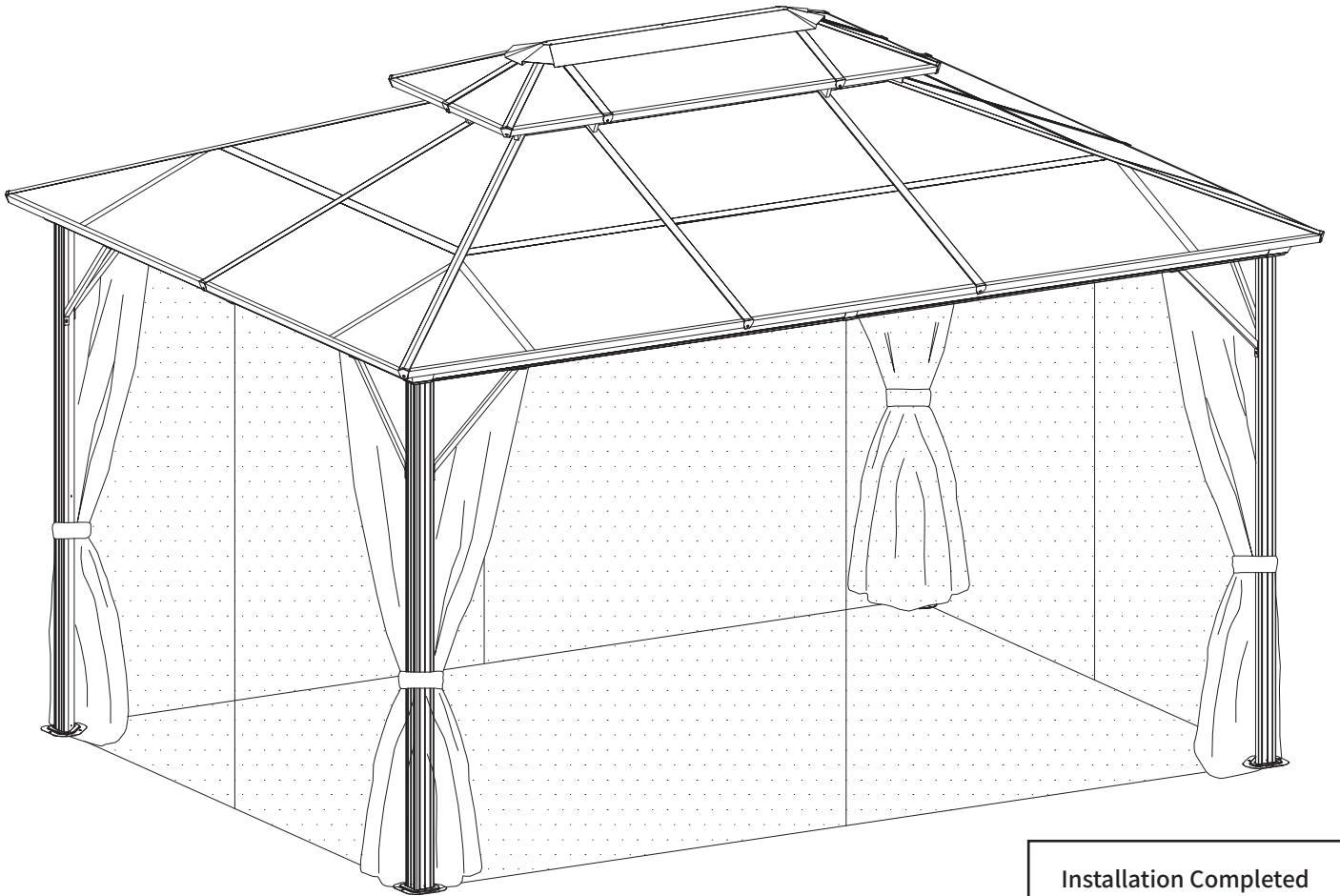

Installation Completed

Installation Abgeschlossen

Installation Complétée

Installazione Completata

Instalación Completada

HELP CENTER



Inquiry



Assembly issue



Missing parts

If you encounter any difficulties during assembly, please contact us.

Wenn Sie während der Montage auf Schwierigkeiten stoßen, kontaktieren Sie uns bitte.

Si vous rencontrez des difficultés lors du montage, veuillez nous contacter.

Se incontri difficoltà durante il montaggio, ti preghiamo di contattarci.

Si encuentras alguna dificultad durante el ensamblaje, por favor contáctanos.

DISCLAIMER

Manufacturer and seller expressly disclaim any and all liability for personal injury, property damage or loss, whether direct, indirect, or incidental, resulting from the incorrect attachment, improper use, inadequate maintenance, unapproved modification, or neglect of this product.

Der Hersteller und Verkäufer lehnen ausdrücklich jegliche Haftung für Personenschäden, Sachschäden oder Verluste ab, egal ob direkt, indirekt oder zufällig, die durch falsche Anbringung, unsachgemäßen Gebrauch, unzureichende Wartung, nicht genehmigte Änderungen oder Vernachlässigung dieses Produkts entstehen.

El fabricante y vendedor renuncian expresamente a toda responsabilidad por lesiones personales, daños materiales o pérdidas, ya sean directos, indirectos o incidentales, derivados de la incorrecta colocación, uso inadecuado, mantenimiento insuficiente, modificación no aprobada o negligencia de este producto.

Il produttore e il venditore declinano espressamente ogni responsabilità per lesioni personali, danni materiali o perdite, dirette, indirette o incidentali, derivanti dall'errato fissaggio, uso improprio, manutenzione inadeguata, modifica non autorizzata o negligenza di questo prodotto. Le fabricant et le vendeur déclinent expressément toute responsabilité en cas de blessures corporelles, de dommages matériels ou de pertes, qu'ils soient directs, indirects ou accessoires, résultant de la fixation incorrecte, de l'utilisation inappropriée, de l'entretien insuffisant, de la modification non approuvée ou de la négligence de ce produit.