

# 60057 DINING CHAIR ASSEMBLY INSTRUCTION

Thank you for purchasing this quality product. Be sure to check all packing material carefully for small parts which may have come loose inside the carton during shipment. Separate, identify and count all parts and hardware. Compare with the parts list to be sure all parts are present.

**IMPORTANT : PLEASE READ INSTRUCTION BEFORE STARTING THE ASSEMBLY.**

**"DO NOT TIGHTEN SCREWS UNTIL COMPLETELY ASSEMBLED"**

**"DO NOT OVERTIGHT ANY HARDWARE"**

**WARNING : SMALL PARTS AND HARDWARE NOT FOR CHILDREN UNDER 3 YEARS. ADULT ASSEMBLY REQUIRED.**

## TABLE OF CONTENTS

HARDWARES LIST	PAGE 2
PARTS LIST	PAGE 3
PARTS' LOCATION	PAGE 4
ASSEMBLY STEPS	PAGE 5
ASSEMBLY COMPLETED	PAGE 6

## ASSEMBLY TOOLS REQUIRED

1. Screwdriver (not provide)

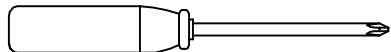

2. Hammer (not provide)

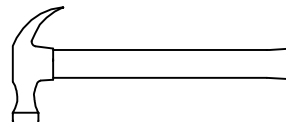



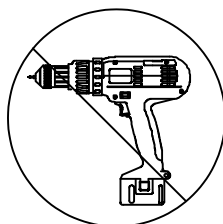



Skip the power drill this time.



# 60057 DINING CHAIR ASSEMBLY INSTRUCTION

## HARDWARES LIST

ITEM	DESCRIPTION	DRAWING	QTY
A	JCBC SCREW M6 x 40MM		2 PCS
B	JCBC SCREW M6 x 60MM		8 PCS
C	JCBC SCREW M6 x 80MM		8 PCS
D	SPRING WASHER M6 x 12mm		18 PCS
E	FLAT WASHER M6 x 19mm		18 PCS
F	M4 ALLEN KEY (100MM)		1 PC

The hardware pack includes the hardware for TWO (2) chairs.

# 60057 DINING CHAIR ASSEMBLY INSTRUCTION

## PARTS LIST

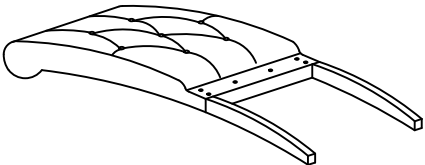
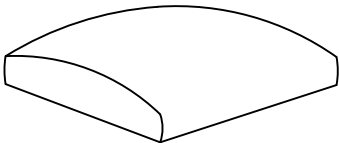
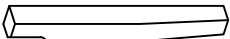
ITEM	DESCRIPTION	DRAWING	QTY
1	BACKREST		2 PCS
2	SEAT		2 PCS
3	FRONT LEG		4 PCS

# 60057 DINING CHAIR ASSEMBLY INSTRUCTION

## PARTS ' LOCATION

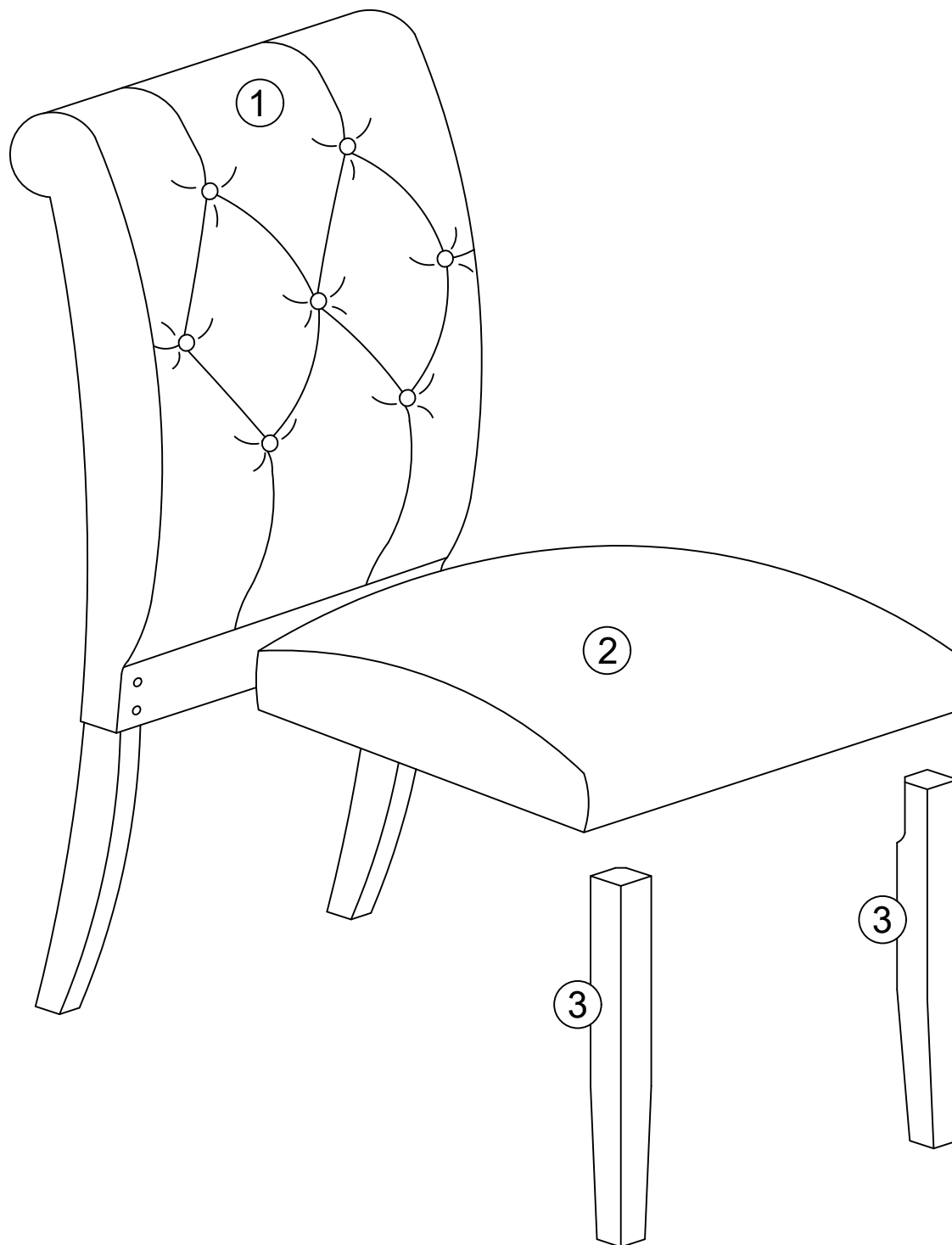

# 60057 DINING CHAIR ASSEMBLY INSTRUCTION

## STEP 1

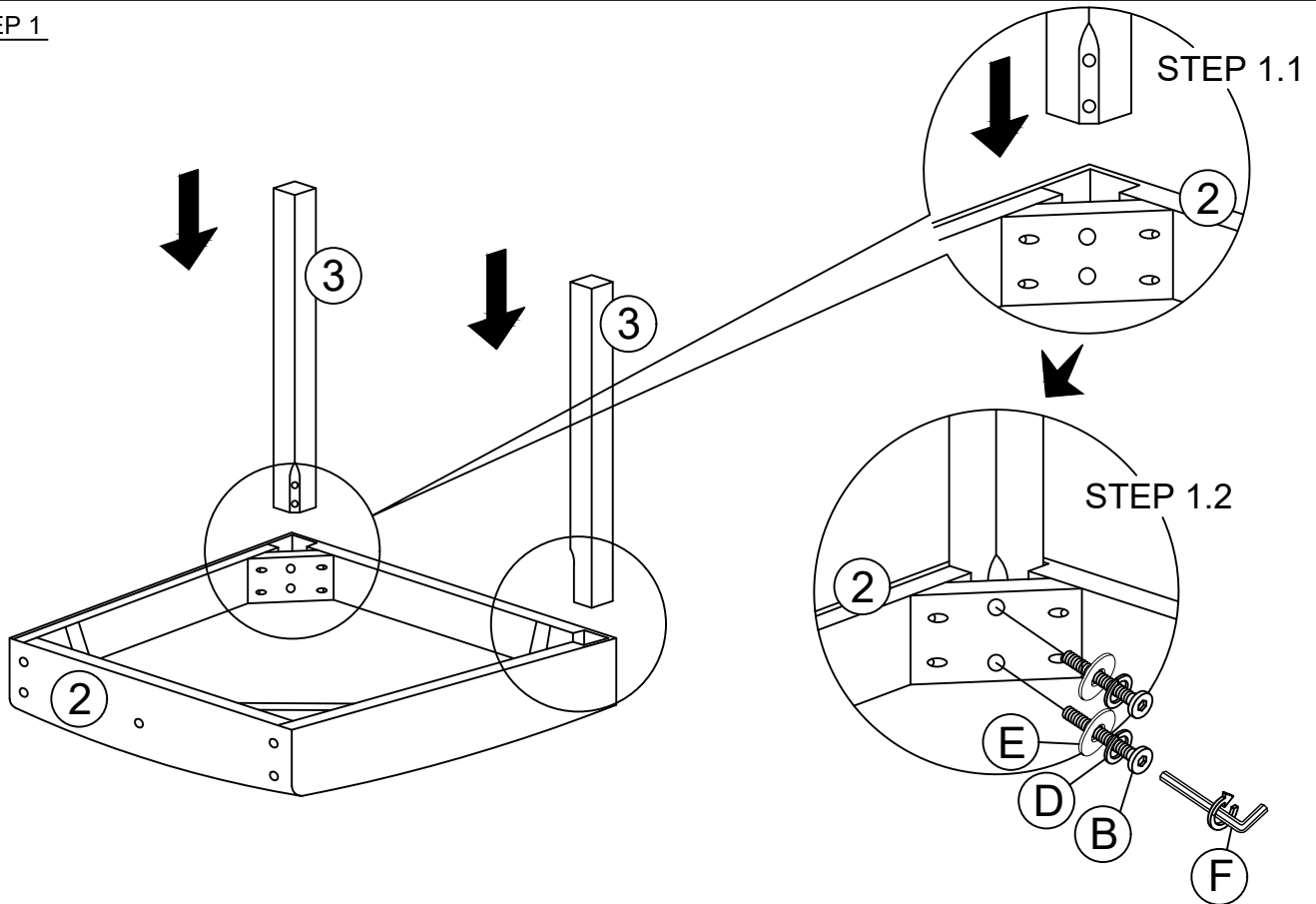

## STEP 2

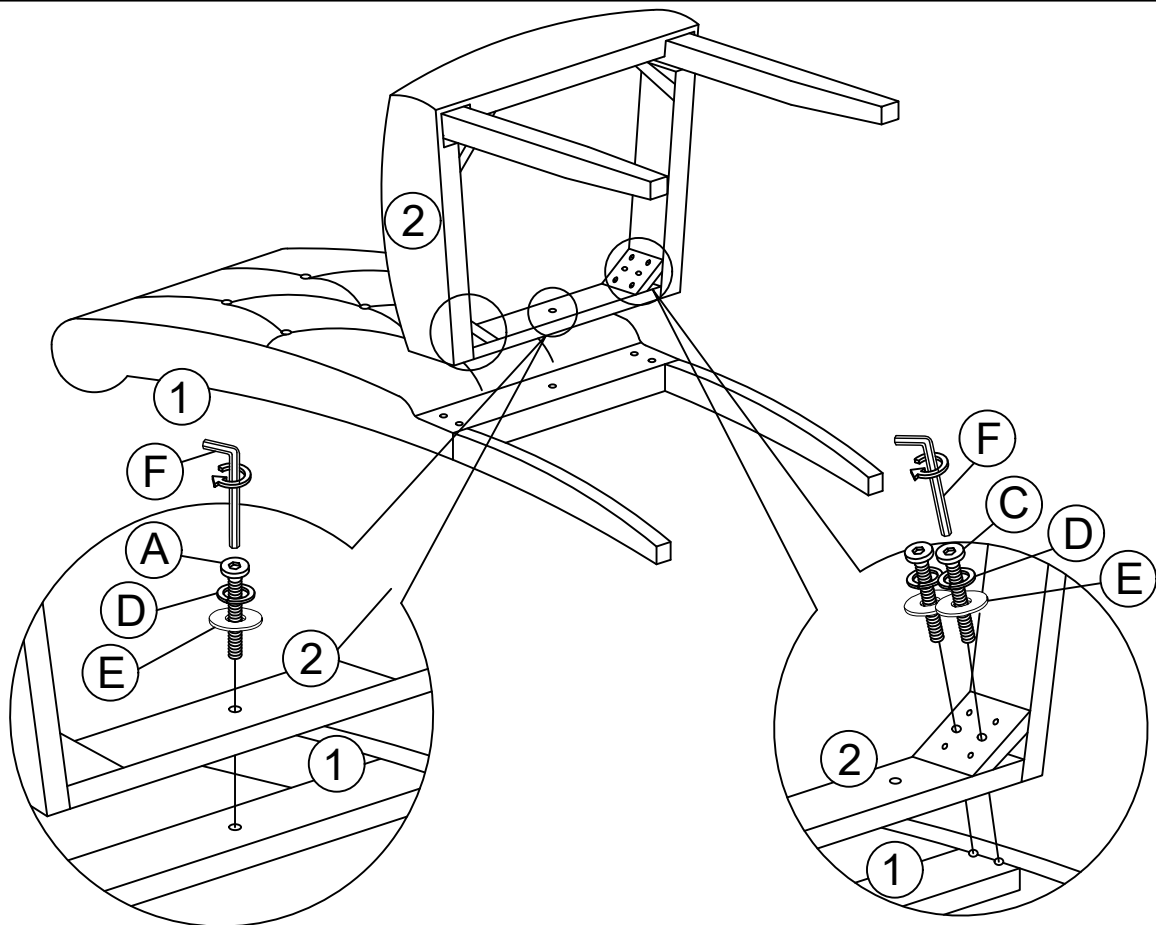

60057 DINING CHAIR ASSEMBLY INSTRUCTION

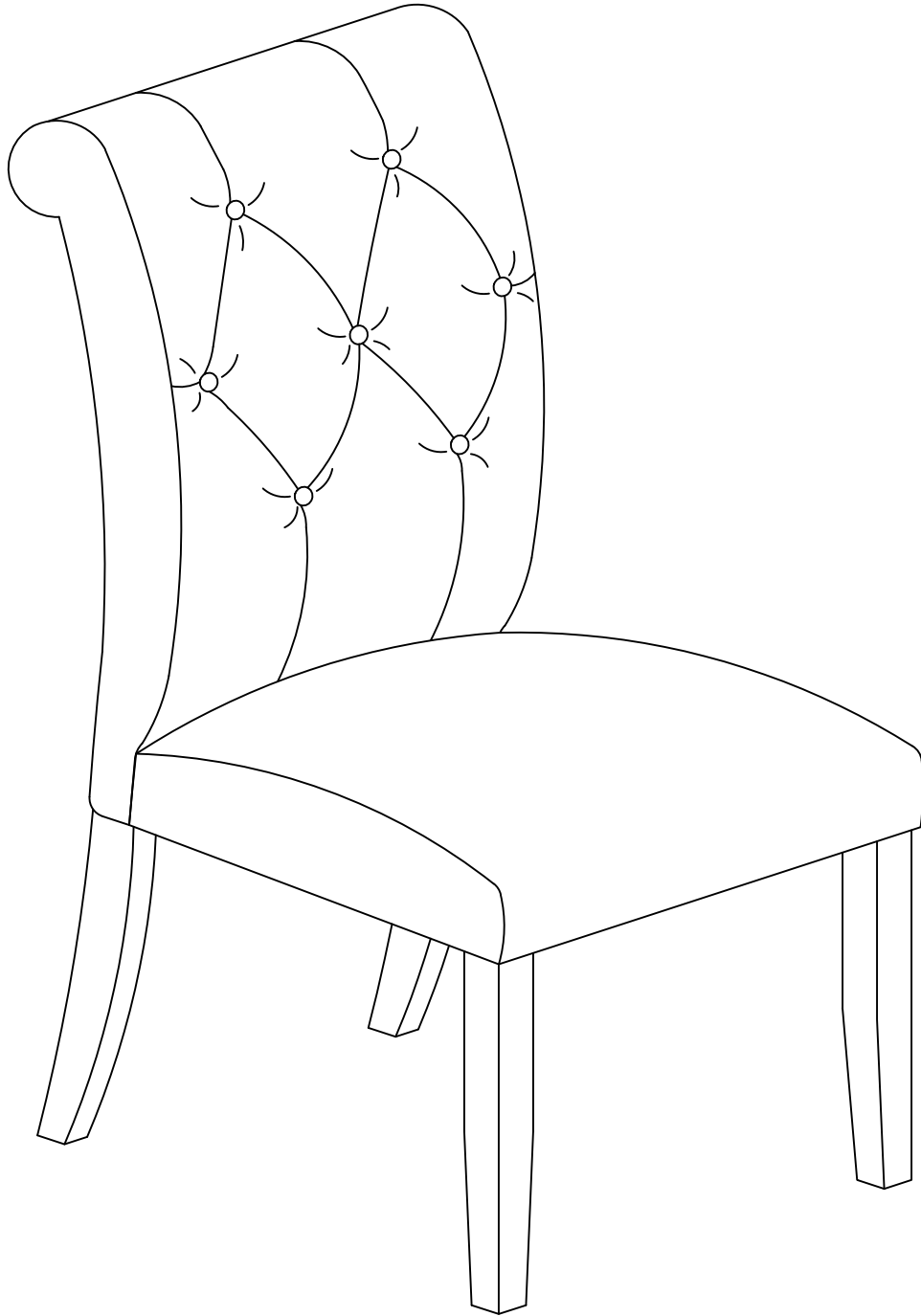

ASSEMBLY  
COMPLETED