

ASSEMBLY INSTRUCTIONS

TWIN HOUSE LOFT BED

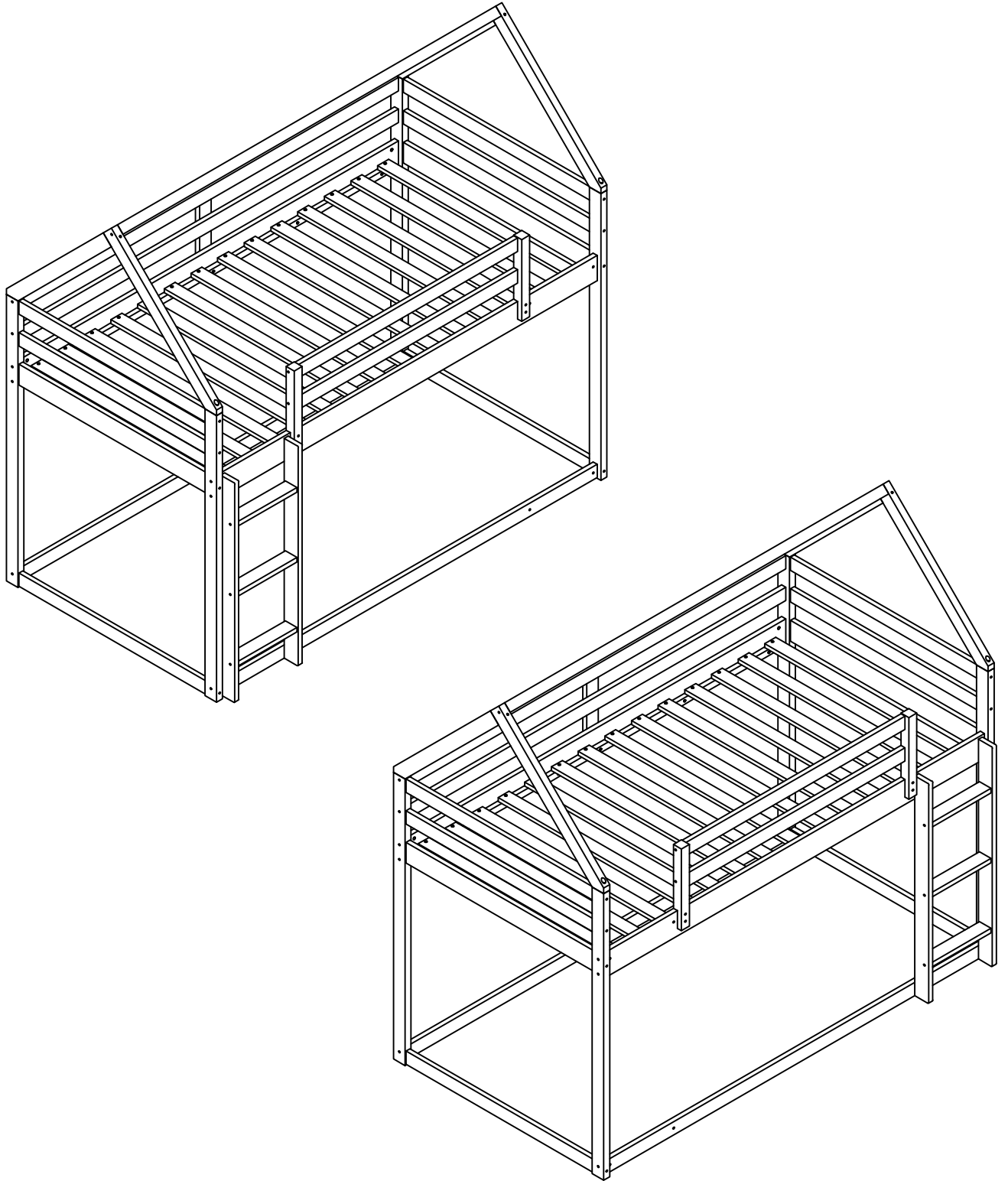

ASSEMBLY INSTRUCTIONS

SAFETY WARNINGS AND GENERAL NOTES:

- Follow the information on the warnings on the bunk bed end structure and on the carton. Do not remove the warning label from the bed. Always use the recommended size mattress on mattress support, or both, to help prevent the likelihood of entrapment or falls.
- The top surface of the mattress must be at least 5*inch (127mm) below the upper edge of the guardrail.
- Do not allow children under 6 years of age to use the upper bunk.
- Periodically check and ensure the guardrail, ladder and other components are in their proper position, free from damage, and all connectors are tight.
- Do not allow horseplay on or under beds.
- Always prohibit jumping on the bed.
- Prohibit more than one person on upper bunk.
- Always use the ladder for entering and leaving the upper bunk.
- Do not use substitute parts. Contact the manufacturer or dealer for replacement parts.
- Use of a night-tight may provide added safely precaution for a child using the upper bunk.
- Always use guardrails on both long sides of the upper bunk.
- If the loft bed will be placed next to a wall, the guardrail that runs the full length of the bed should be placed against the wall to prevent entrapment between the bed and the wall.
- The use of water or sleep flotation mattresses is prohibited.







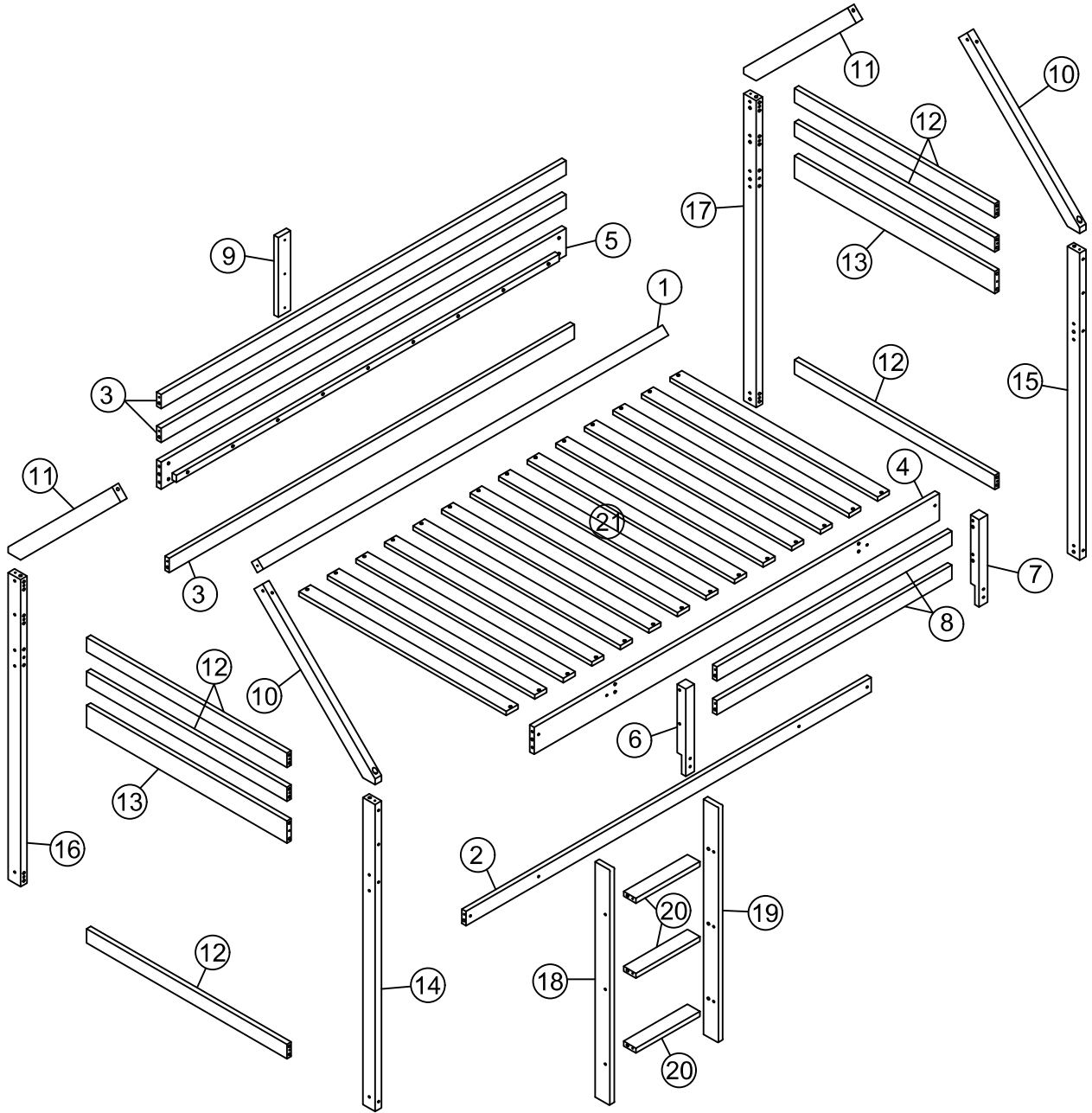

STRANGULATION HAZARD- Never attach or hang items to any part of the bunk bed that are not designed for use with the bed.

- Keep these instructions for future reference.
- We recommend assembling your loft bed on the shipping carton to protect your floor or carpet.
- Be certain all staples are out of the box before beginning assembly on the shipping carton.
- USE ONLY MATTRESSES WHICH ARE 74"-75" LONG AND 37 1/2" - 38 1/2" WIDE ON UPPER AND ON LOWER BUNKS. ENSURE THICKNESS OF MATTRESS DOES NOT EXCEED 6".
- SURFACE OF MATTRESS MUST BE AT LEAST 5" (127MM) BELOW THE UPPER EDGE OF GUARDRAILS.
- Replacement Parts: Replacement Parts, including additional guardrails, may be obtained from any of our (COMPTREE INC.) dealers

ASSEMBLY INSTRUCTIONS





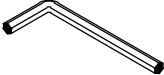



HARDWARE LIST (WF285733)

A	Ø4x25		28PCS	F	6.5x50		4PCS
B	Ø4x30		3PCS	G	1/4x75		8PCS
C	6.5x100		18PCS	H	1/4x35		4PCS
D	6.5x80		14PCS	I	Ø10x40		60PCS
E	6.5x60		10PCS	J	4x58		1PC

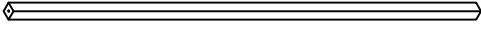
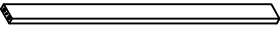
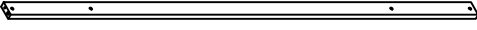
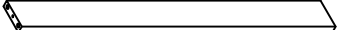
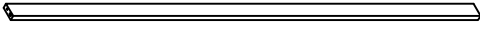
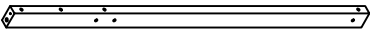
ASSEMBLY INSTRUCTIONS

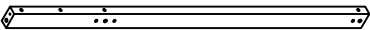
PARTS LIST

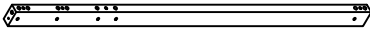
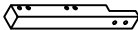
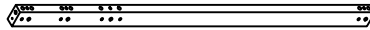

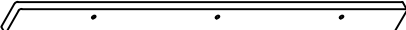
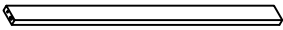
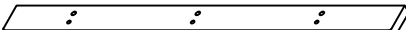
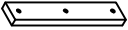
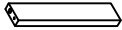
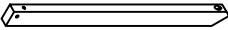
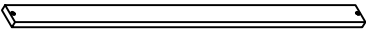
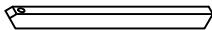
WF285733

1	 Top cross bar	1pc	12	 Middle & bottom bars	6pcs
2	 Bottom front bar	1pc	13	 Bottom bars	2pcs
3	 Top & bottom back bar	3pcs	14	 Left front leg	1pc
4	 Front side rails	1pc	15	 Right front leg	1pc
5	 Back side rails	1pc	16	 Left back leg	1pcs
6	 Left guard rails support	1pc	17	 Right back leg	1pcs
7	 Right guard rails support	1pc	18	 Left stair side or left stair side	1pc
8	 Top & bottom guard rails support	2pcs	19	 Right stair side or left stair side	1pc
9	 Back guard rails support	1pc	20	 Step stair side	3pcs
10	 Front top cross bar	2pcs	21	 Slats	14pcs
11	 Back top cross bar	2pcs			

ASSEMBLY INSTRUCTIONS

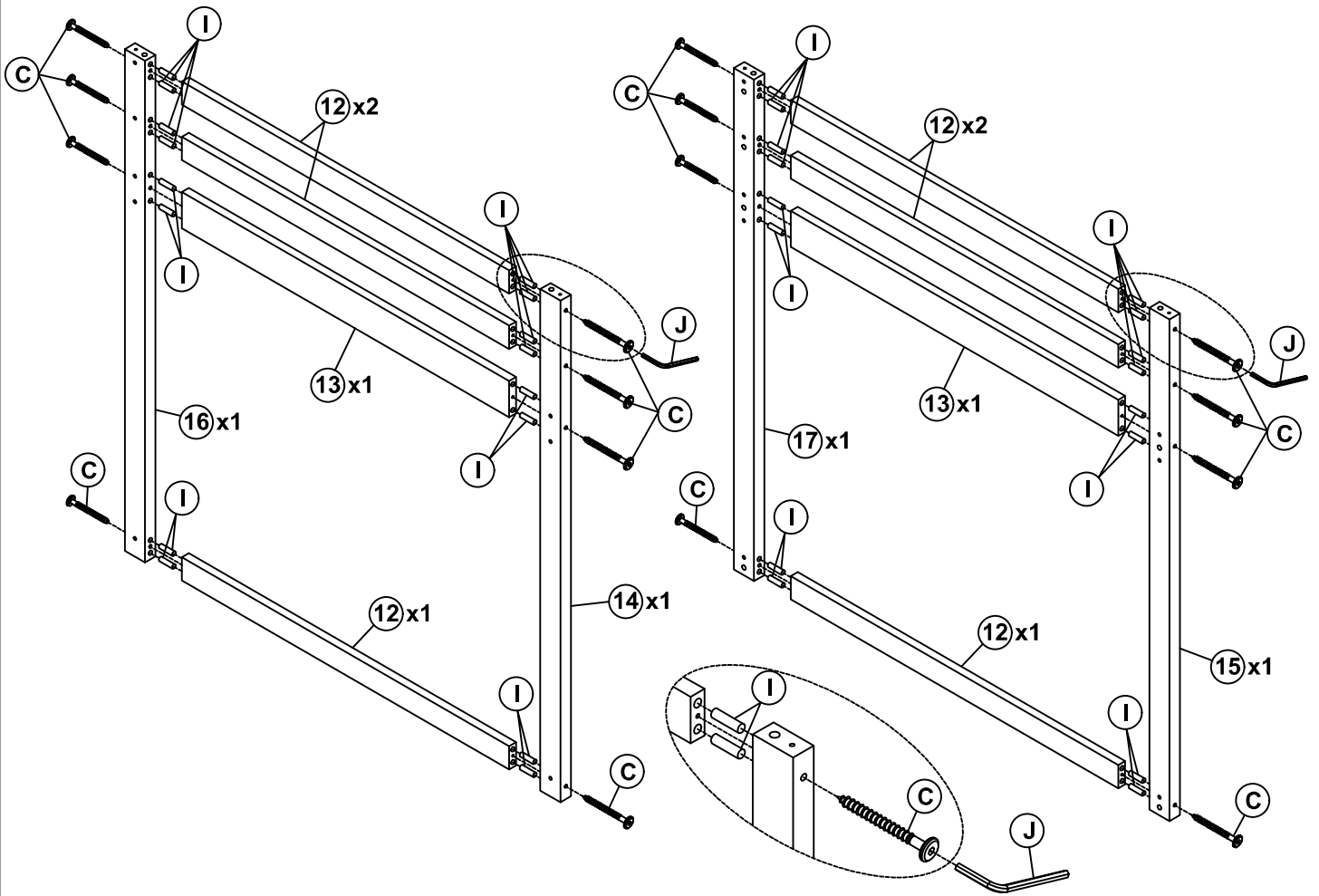
Step 1





J	4x58		1PC
I	Ø10x40		32PCS

C	6.5x100		16PCS
----------	---------	---	-------

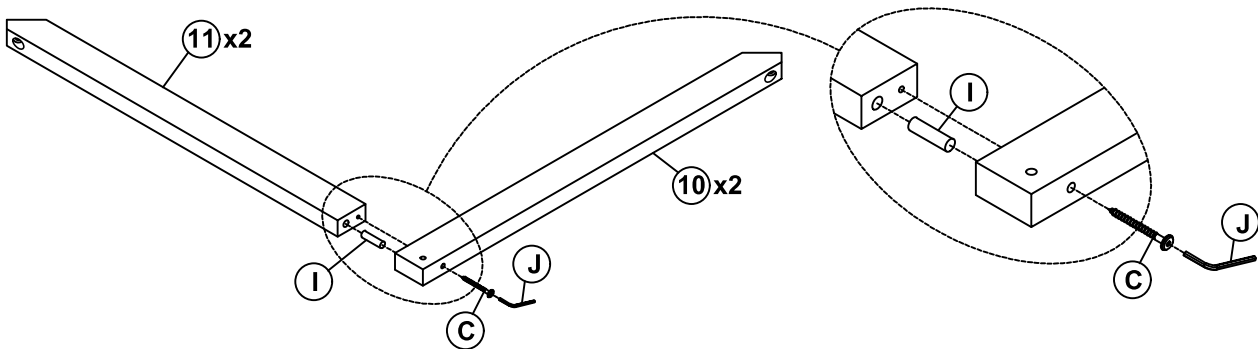
Step 2





C	6.5x100		2PCS
J	4x58		1PC

I	Ø10x40		2PCS
----------	--------	---	------

ASSEMBLY INSTRUCTIONS

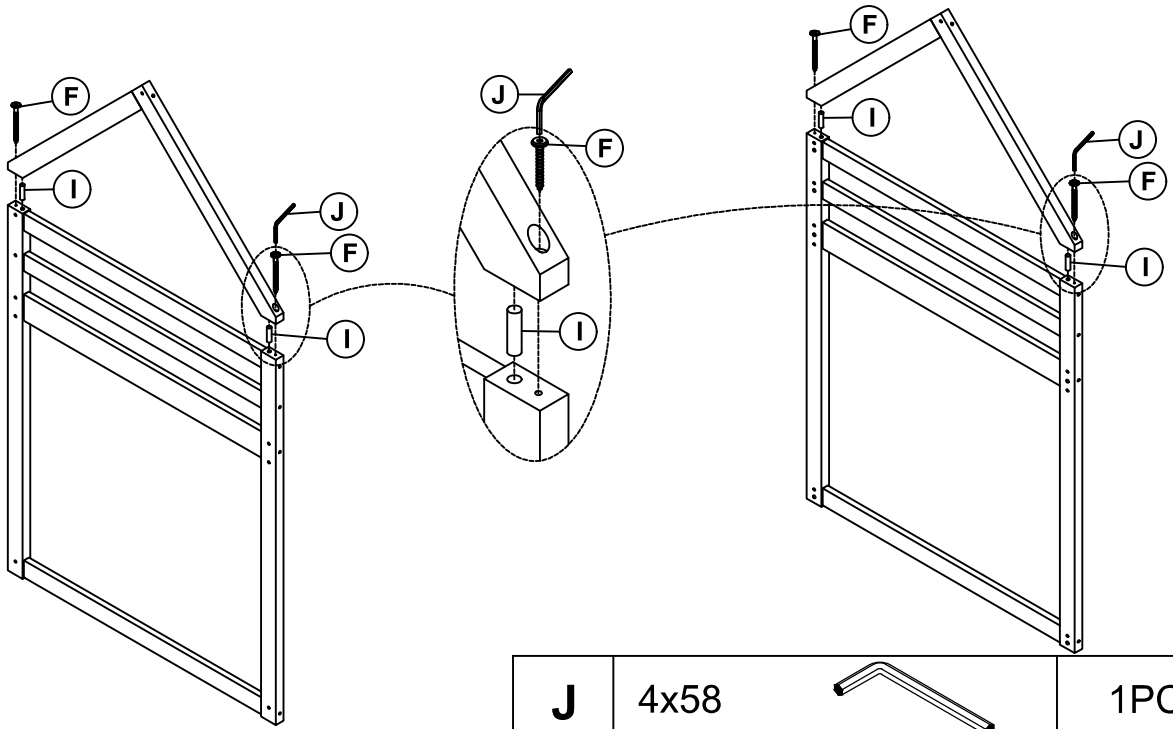

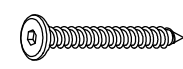

Step 3

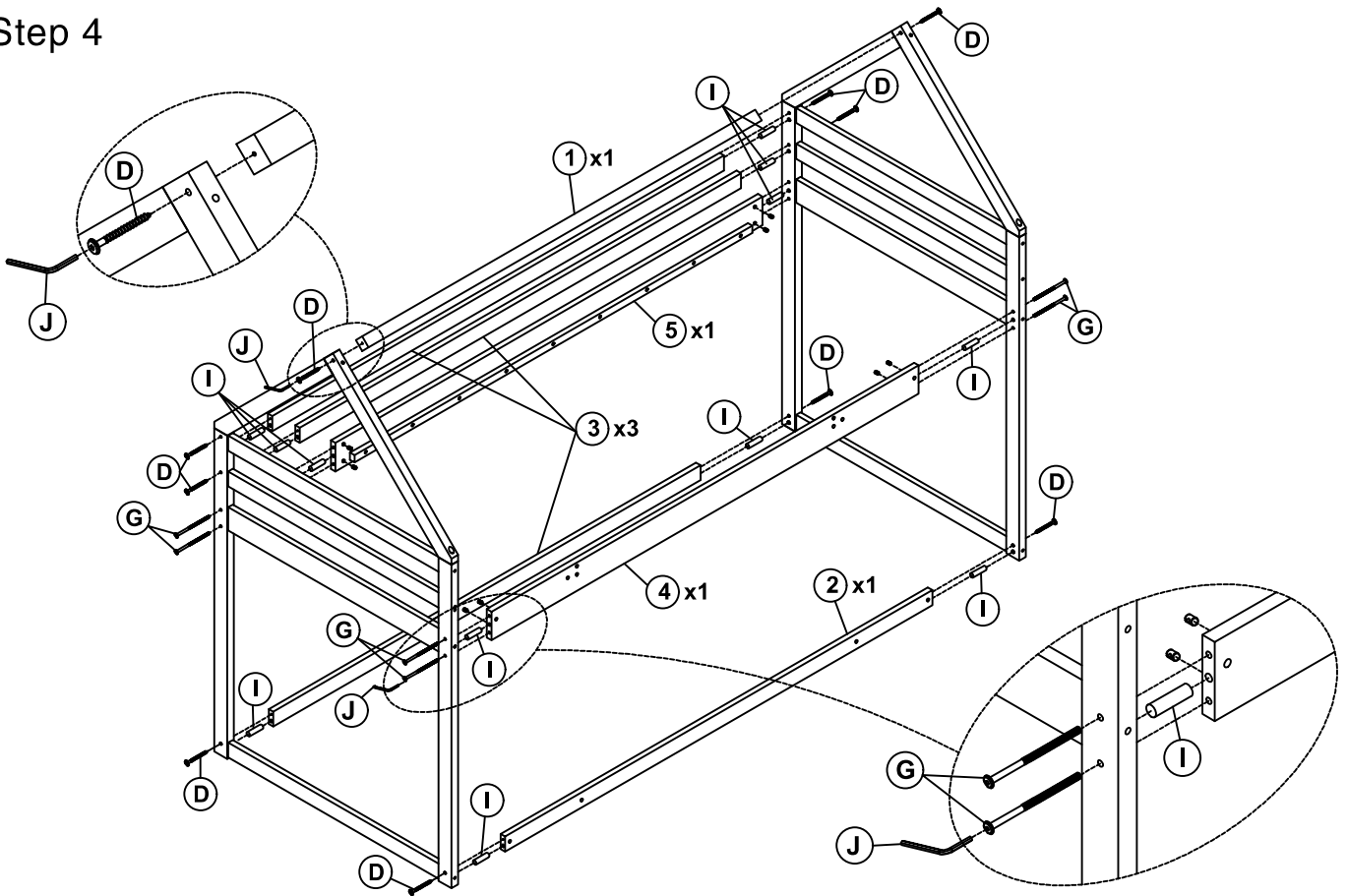

J	4x58		1PC
I	Ø10x40		4PCS
F	6.5x50		4PCS

Step 4



I	Ø10x40		12PCS	D	6.5x80		10PCS
J	4x58		1PC	G	1/4x75		8PCS

ASSEMBLY INSTRUCTIONS

Step 5

First attach 2pcs part 21 to the front and end of the frame between headboard. Then attach the remaining part 21 equidistantly between headboard

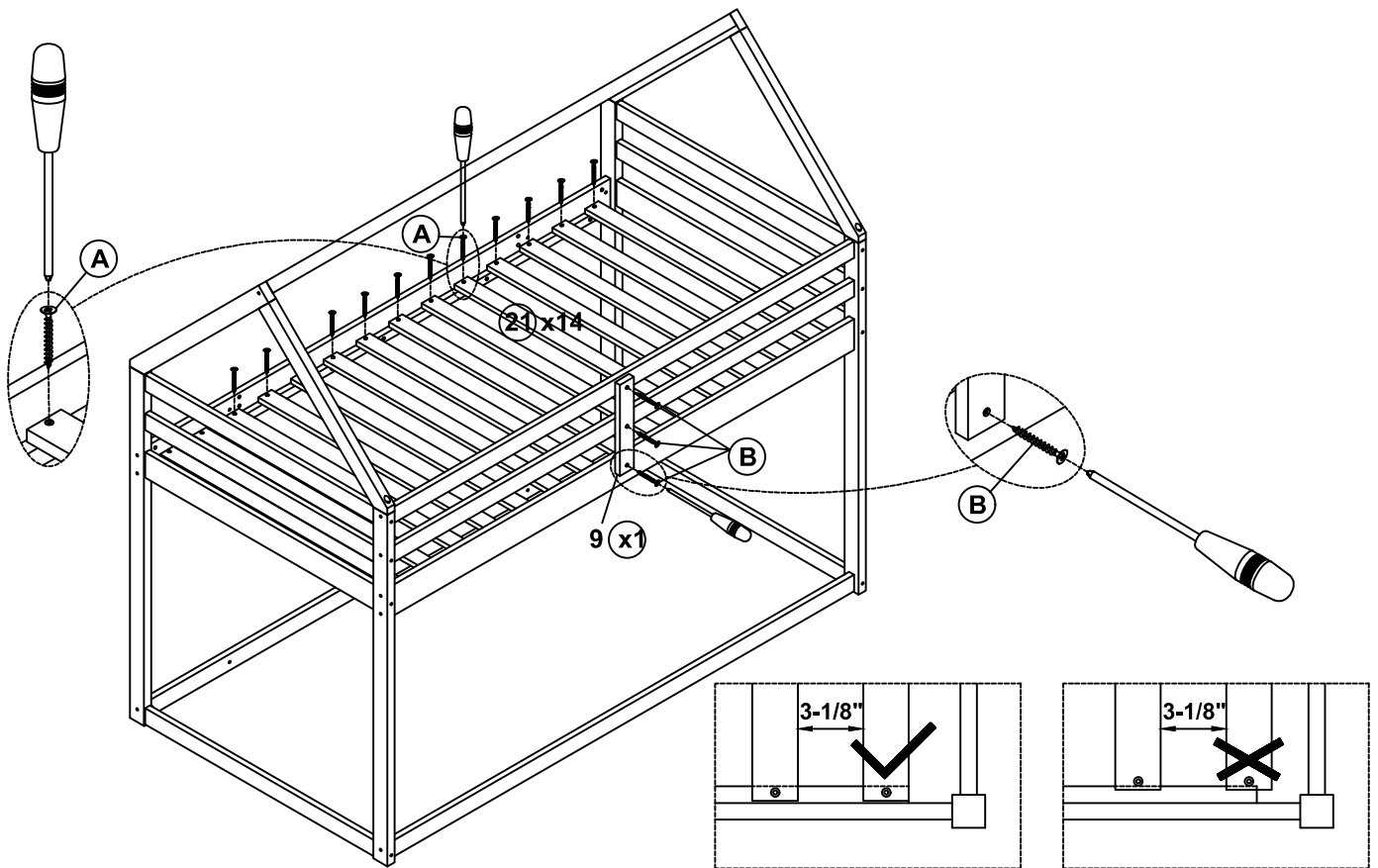



Note : Do not lock the screws of the bed slats to the outermost edge of the bed slats, you need to leave a certain space at the edges, otherwise it will cause the board to break

A Ø4x25  28PCS

B Ø4x30  3PCS

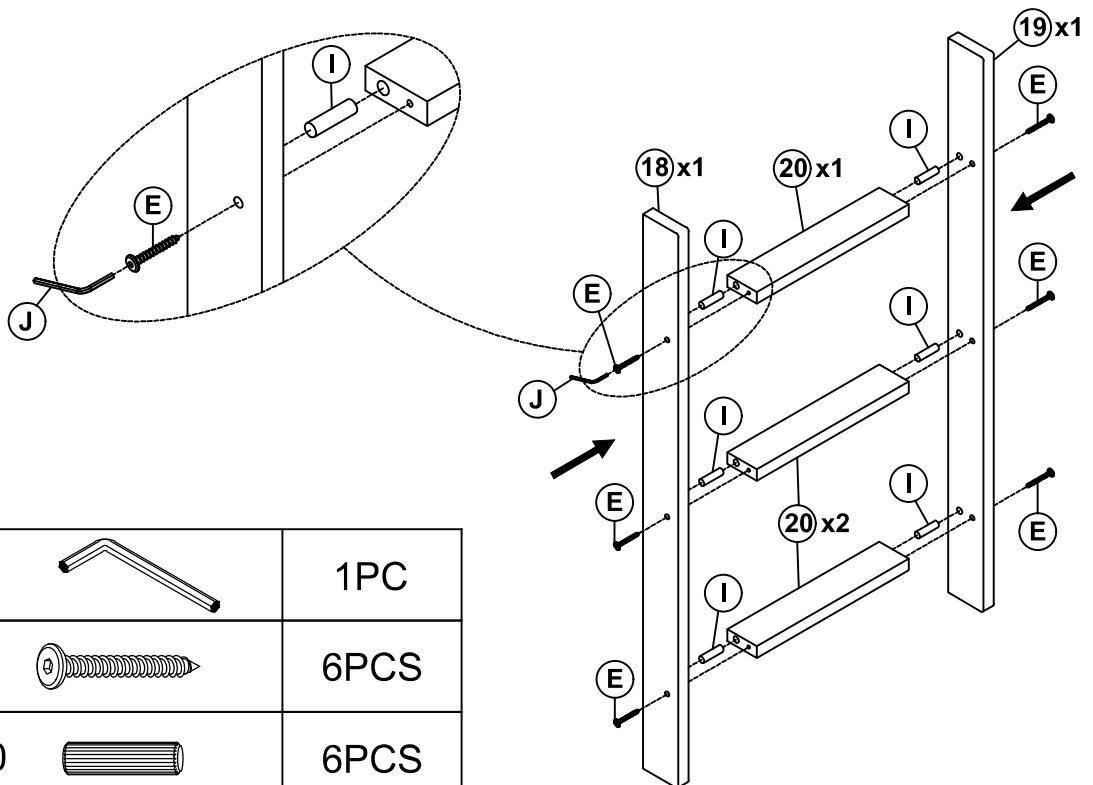
Step 6



J 4x58  1PC



E 6.5x60  6PCS

I Ø10x40  6PCS

ASSEMBLY INSTRUCTIONS

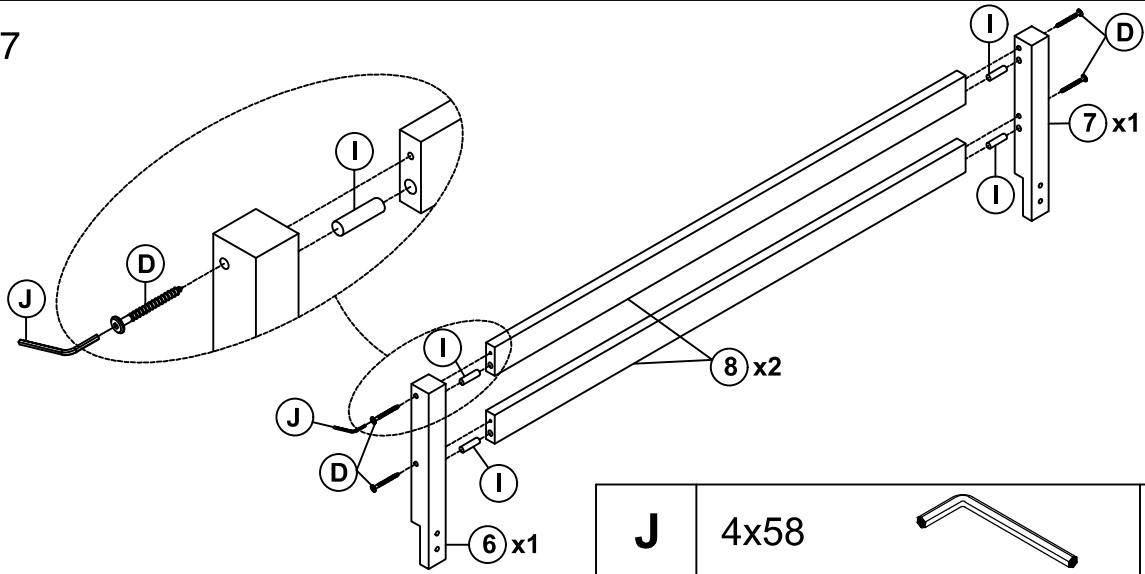
Step 7





J	4x58		1PC
I	Ø10x40		4PCS

D	6.5x80		4PCS
----------	--------	---	------

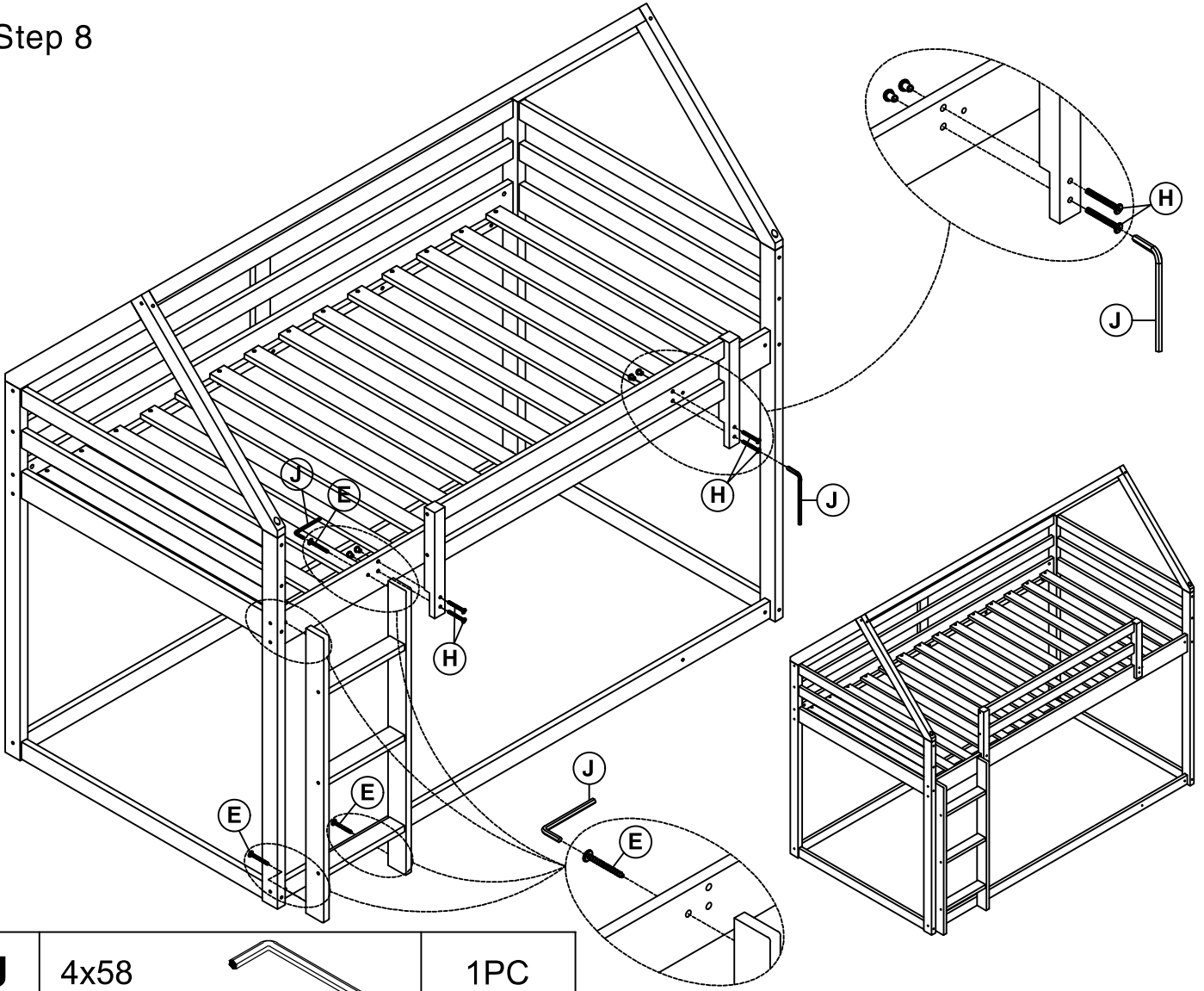
Step 8

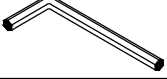

J	4x58		1PC
H	1/4x35		4PCS

E	6.5x60		4PCS
----------	--------	---	------