

Installation & Assembly

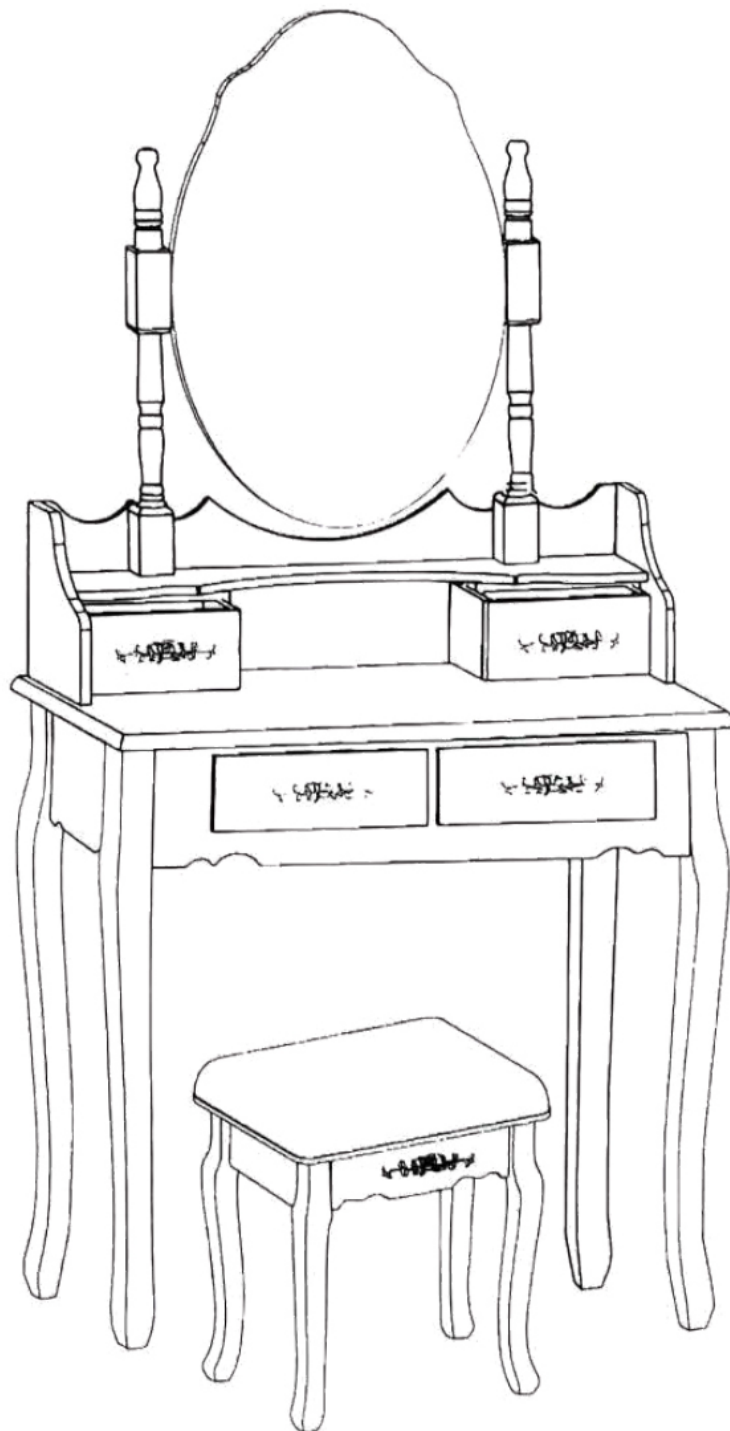

1. General Guidelines

Please read the following instructions carefully before using the product and use the product as required. This summary may not include every detail or necessary step; if further information or assistance is needed, please contact us.

Keep this manual properly and hand it over together with the product when the ownership of the product is transferred.

2. Notes

2.1 Usage & Installation Requirements

The product is only intended for one-time use. The seller shall not bear any responsibility for damage or injury caused by improper use..

Please fix the product to the wall using the provided safety accessories. Do not fully tighten the screws until the entire assembly is completed.

Regularly check screws, bolts, and connection points, and retighten them if necessary.

2.2 Product Protection Measures

Keep the product's surfaces away from sharp objects and corrosive chemicals to prevent surface damage..

Protect the product's surfaces from heat sources and liquids; you may use pads or heat-insulating mats for protection. Wipe off any spilled liquids immediately. When writing on paper placed on the product, put a protector under the paper to avoid direct damage to the product surface..

Clean the product thoroughly with a cloth dipped in neutral detergent, then wipe it dry with a soft cloth. Do not polish the product's surface, as this may cause damage to its components.

3. Warnings

The toppling of the product may result in severe or fatal injuries. Ensure the product is firmly fixed during use. If any part of the product is damaged or missing, stop using the product immediately..

During assembly, keep all small parts and packaging materials (such as plastic films, plastic bags, foam boards, etc.) out of the reach of children to prevent fatal risks caused by swallowing or inhalation.

Children are only allowed to come into contact with the product under the supervision of adults. Do not let children climb on or play with the product to avoid injuries caused by product toppling or mirror breakage.

4. Reference for Accessory Specifications

Some sections of the manual mention the specifications of the product's accessories, including M6x40mm (8PCS), M3.5x30mm (6PCS), M3x25mm (6PCS), M5x20mm (5PCS), M4x50mm (1PCS), etc. During assembly, please check the quantity and specifications of the accessories to ensure the assembly process goes smoothly.

1

× 16

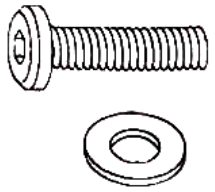

M6 × 40mm

2

× 4

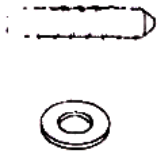

M3.5 × 30mm

3

× 6



M3 × 25mm

4

× 2



M4 × 50mm

5

× 1



6

× 5



M5 × 20mm

7

× 1

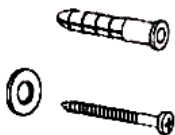

8



A

× 1

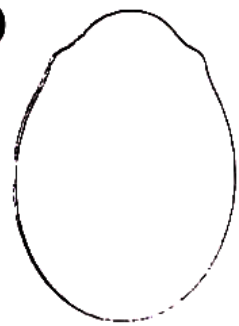

B



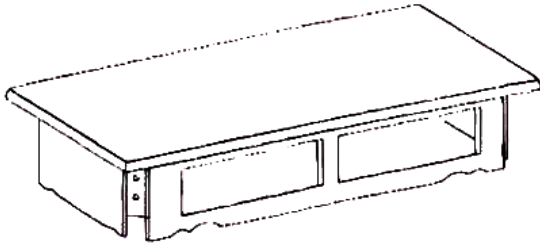



× 1

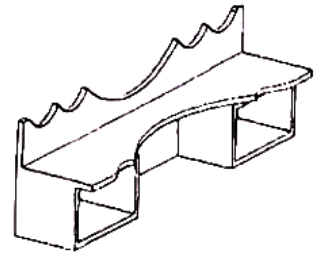

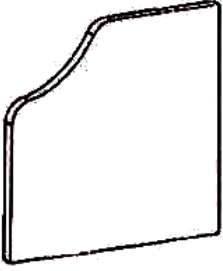
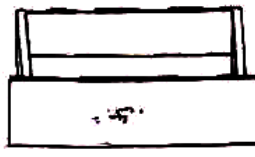

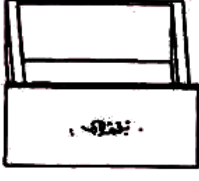
C

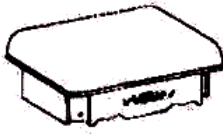
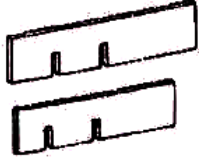
× 1

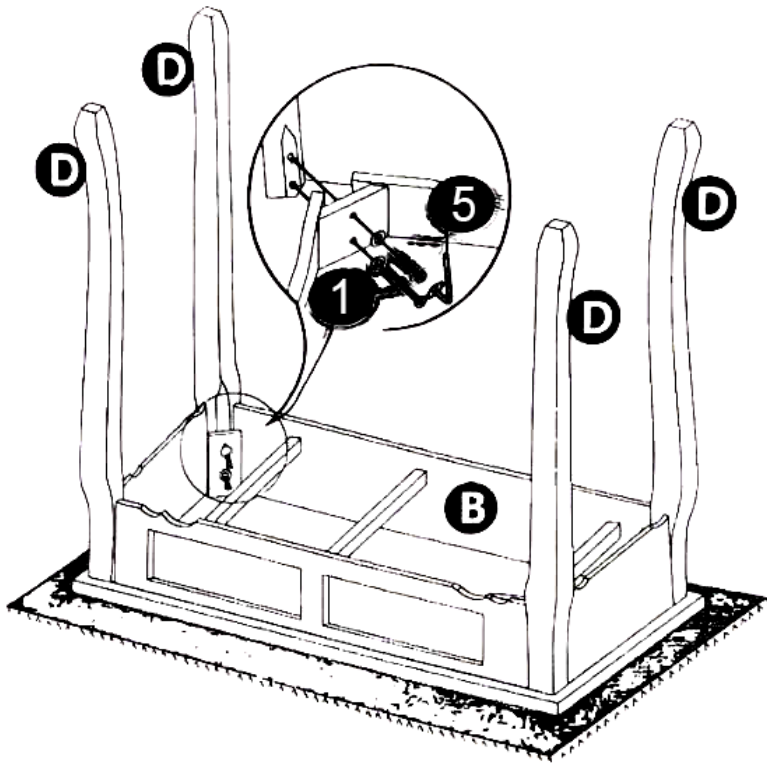

<p>D  x4</p>	<p>E  x2</p>	<p>F  x2</p>
<p>G  x2</p>	<p>H  x2</p>	<p>I  x4</p>
<p>J  x1</p>	<p>K  x1</p>	<p>L  x1</p>



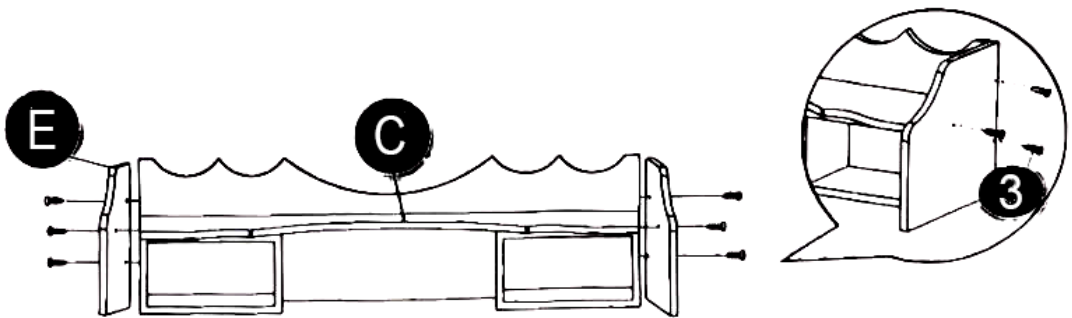

- 5** 
- 1**  8PCS
M6 x 40mm



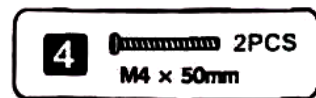
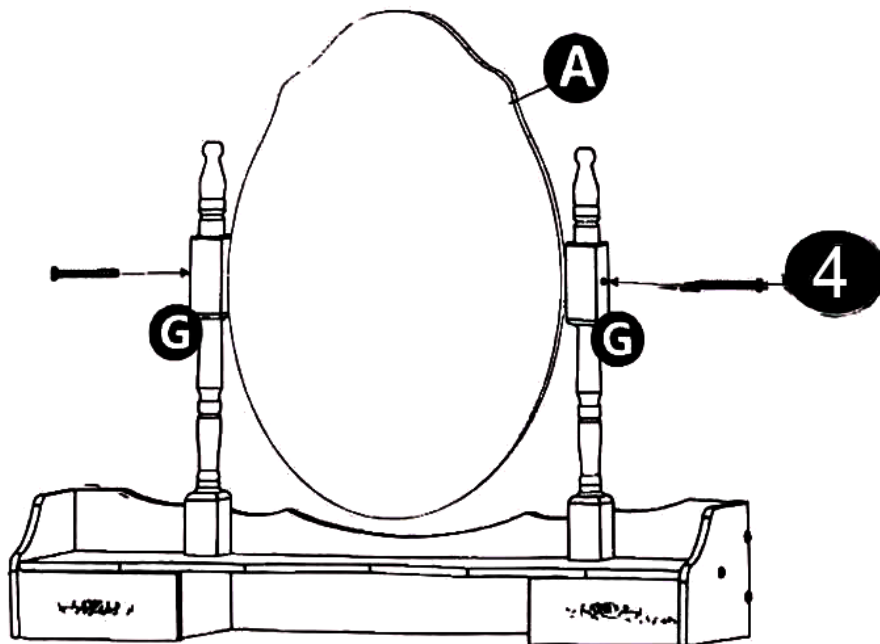
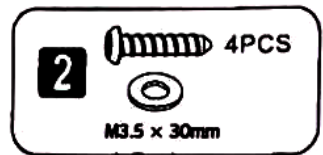
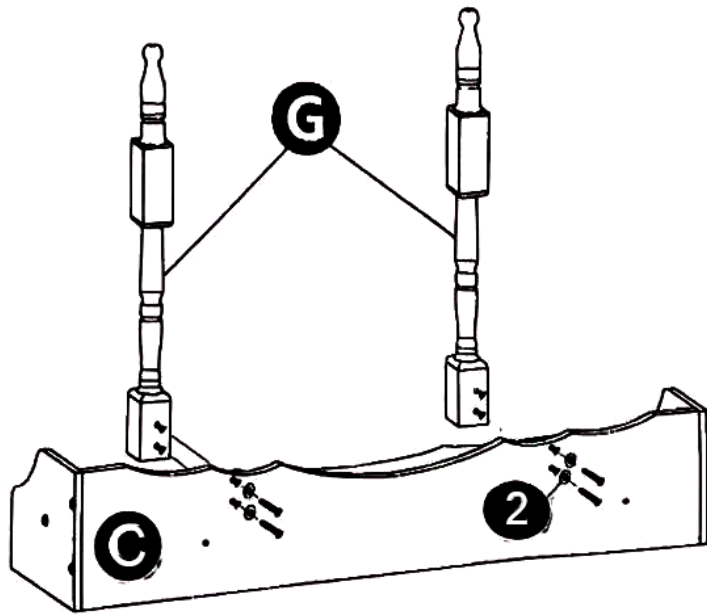

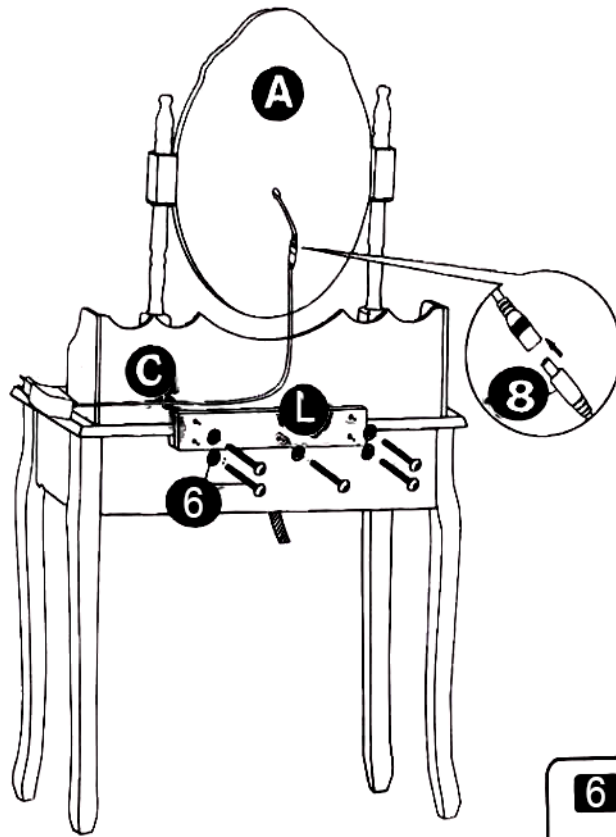
- 3**  6PCS
M3 x 25mm



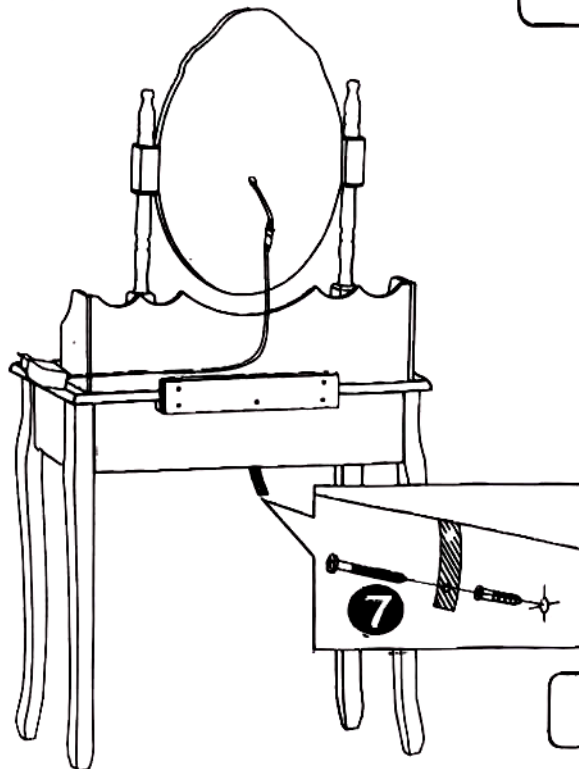

6  5 PCS
M5 x 20mm



7  1 PCS

