

Warranty

We offer a one-year warranty for the light fixtures.

Our warranty ensures that any issues related to the performance or functionality of the light fixtures will be addressed and resolved promptly.

Our dedicated customer service team is available 24 hours a day to assist you. If you have any questions or concerns, we guarantee a response within 24 hours. During the warranty period, if you encounter any problems or need assistance, please don't hesitate to reach out to us via email. To ensure a swift and accurate resolution, kindly provide your order ID and detailed information regarding the issue.

Important Note: Please use this light fixture only for its intended purpose and avoid retrofitting or remodeling it. The warranty does not cover failures caused by third-party products or natural disasters.

INSTALLATION INSTRUCTION

(115cm)

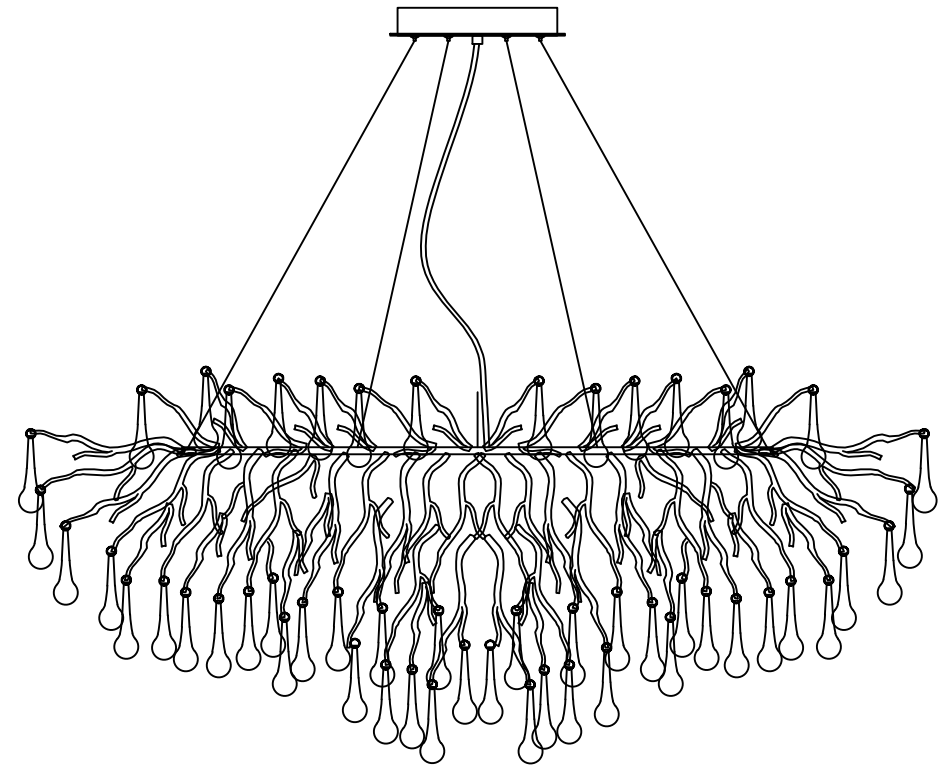

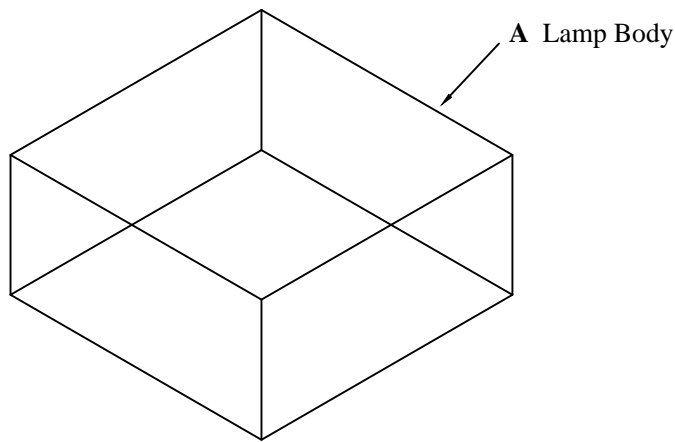

SAFETY INFORMATION

It is important to thoroughly read and understand the entire manual, before assembling, operating, or installing the product,

WARNING

- TURN OFF ELECTRICITY before installation, changing bulbs, or cleaning the light fixture.
- This fixture requires 13 pieces G9 bulbs(not included in the product, the maximum wattage for each bulb is 40W, please do not exceed the recommended wattage.
- A QUALIFIED ELECTRICIAN IS RECOMMENDED FOR INSTALLATION.
- Do not use corrosive substances such as gasoline or alcohol disinfectants to wipe the lamps, otherwise it will damage the lamps.

PREPARATION

- Before installation, please make sure all the accessories are included (refer to the package content), if there is any part missing, please contact us at the order page, we will arrange the replacement in a timely manner
- 13 pieces of G9 bulbs(Max. 40W) are required(not included in the product)
- For any questions or inquires, please feel free to contact us at the order page, our customer service team will reply ASAP.

Please note:
Please check the parts list, if the parts are missing during your actual installation, please contact us, we will help you in time!

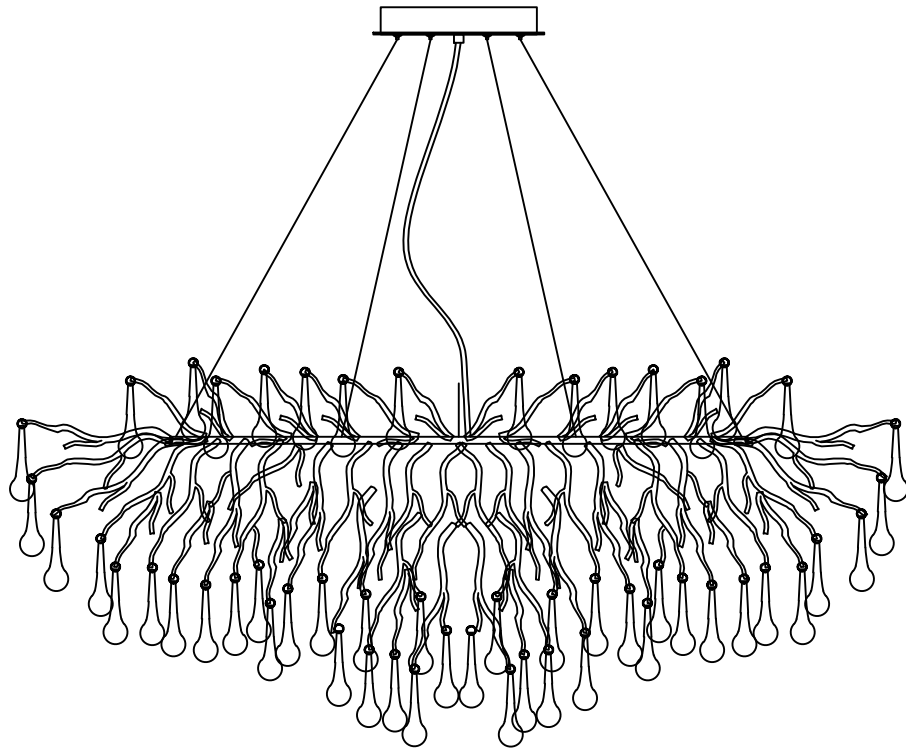

PACKAGE CONTENTS

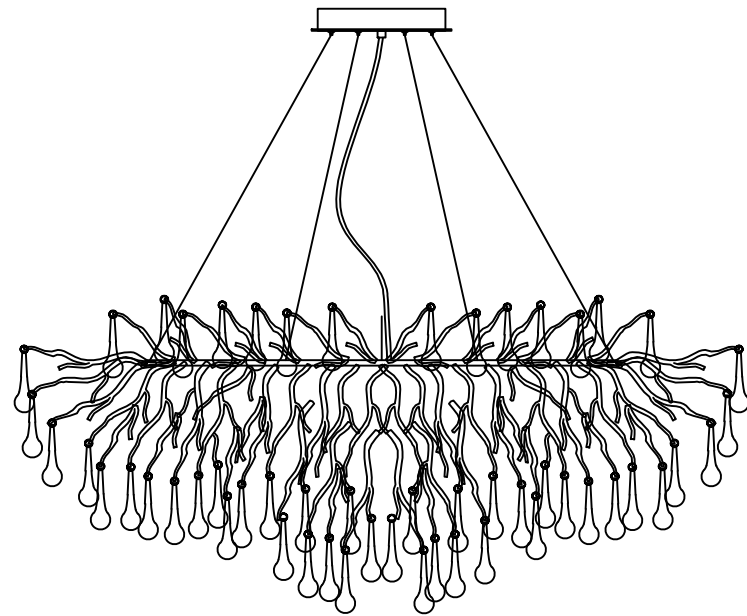
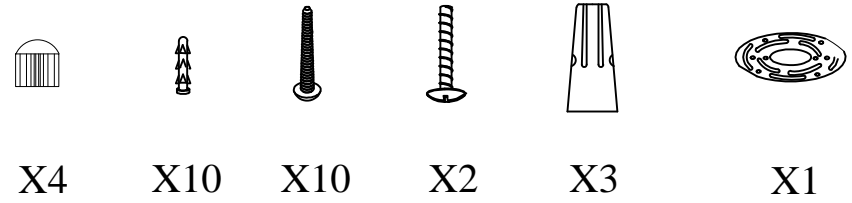

pendant-280



G9 Bulbs-13
(not included)

Please note:
Please check the parts list, if the parts are missing during your actual installation, please contact us, we will help you in time!

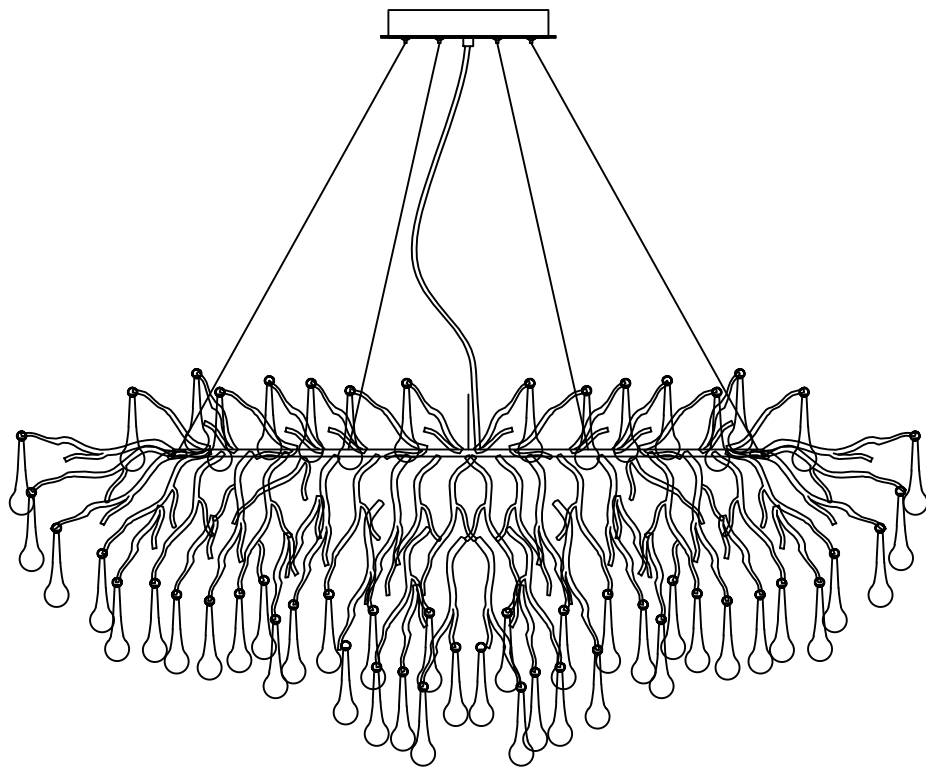

Steps:

1. Take out the lamp body and check the firmness of the lamp body;

install effect A(Flat ceiling)

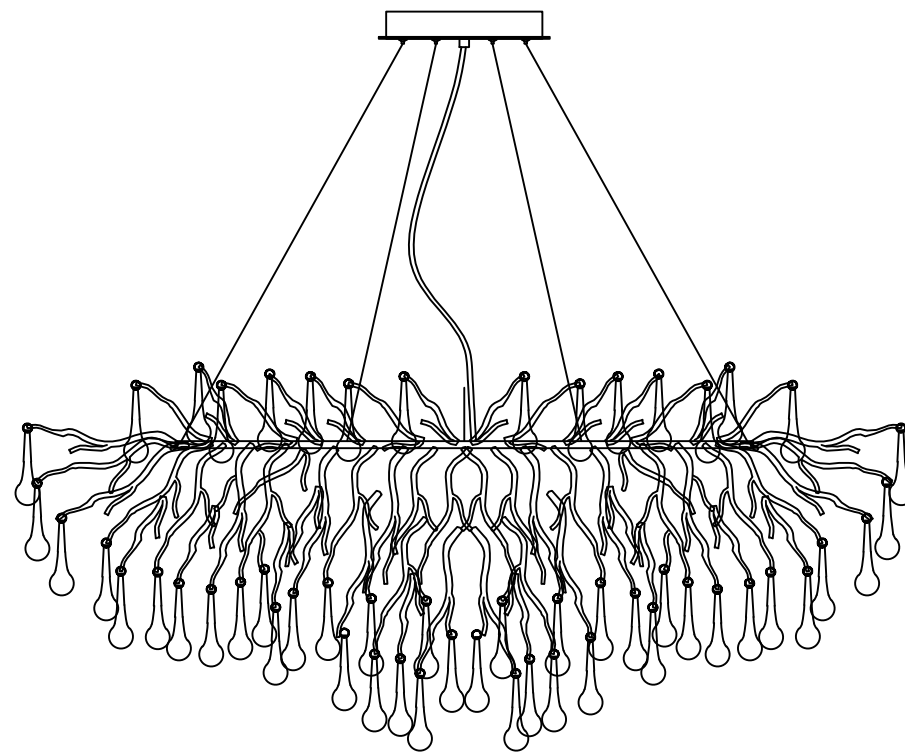

NOTES: Due to the handmade nature of the product, slight variations in dimensions may occur.

Maintenance:

To ensure safe and efficient use of this product, please clean the lamp regularly (once a month). Before cleaning, turn off the power and wait for the lamp to cool to room temperature. Then use a soft cloth dipped in water and wrung dry to wipe it clean.

install effect A(angle ceiling)

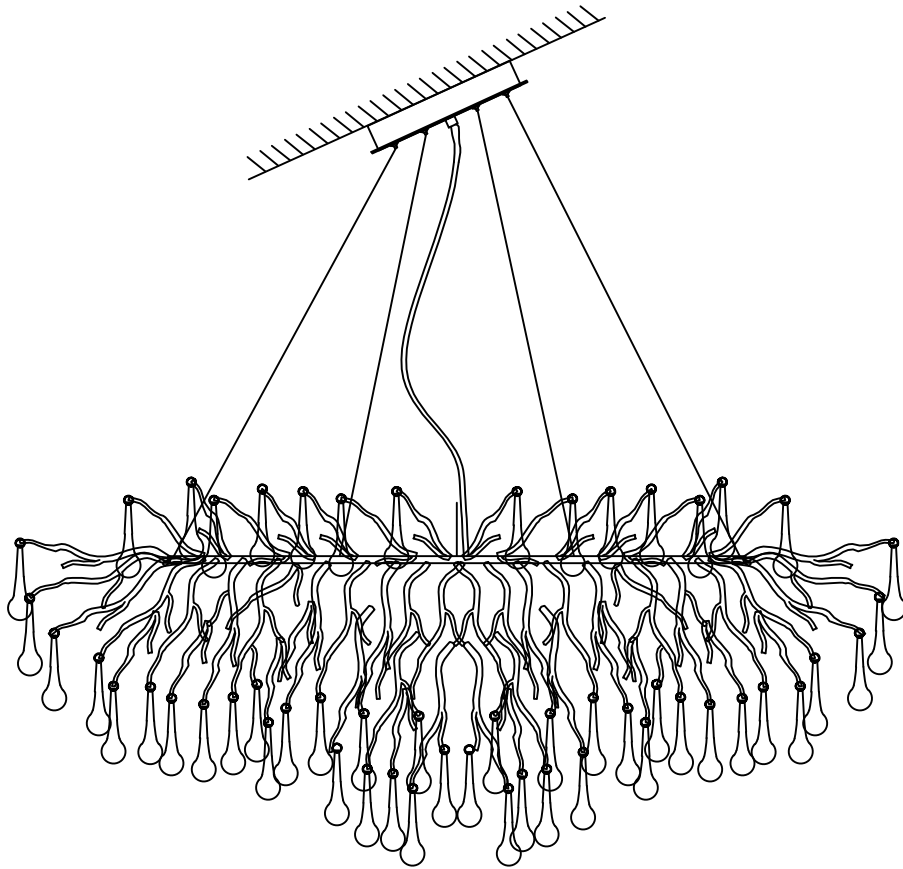

NOTES: Due to the handmade nature of the product, slight variations in dimensions may occur.

Cautions.

- 1.This lamp can only be used indoors;
- 2.TURN OFF THE POWER BEFORE THE INSTALLATION IS FINISHED.

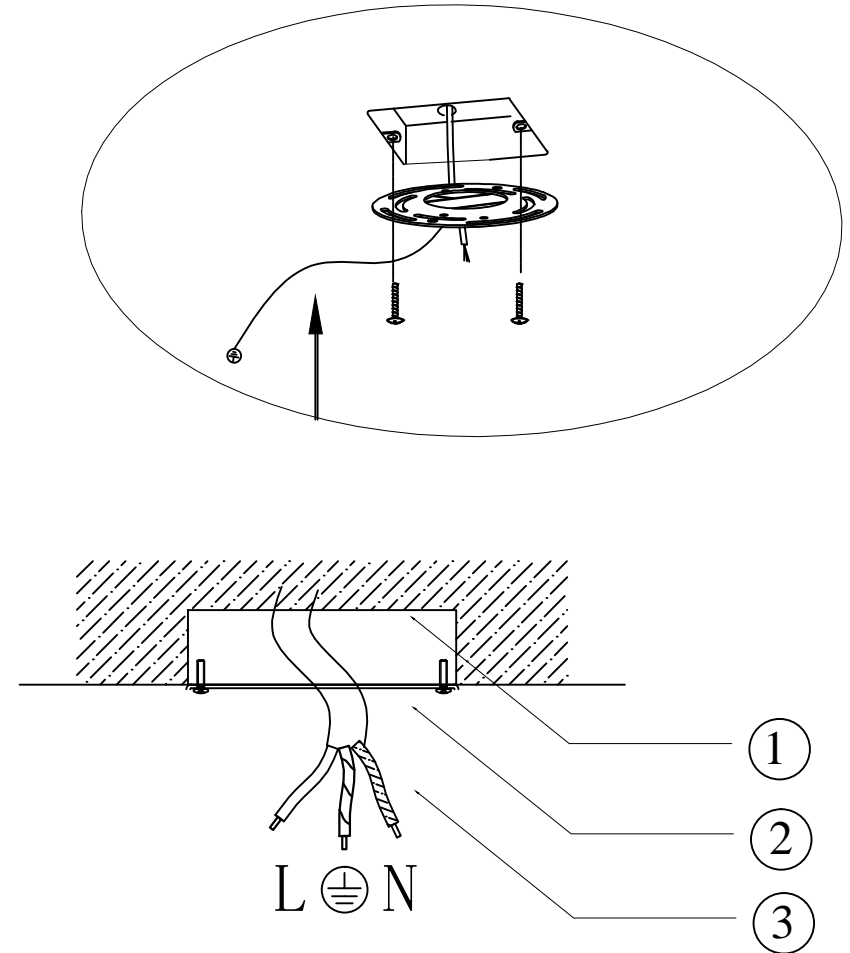

Steps:

- 1.Remove the crossbar from the preassembled mounting base;
- 2.Lock the crossbar on the junction box with the screw.

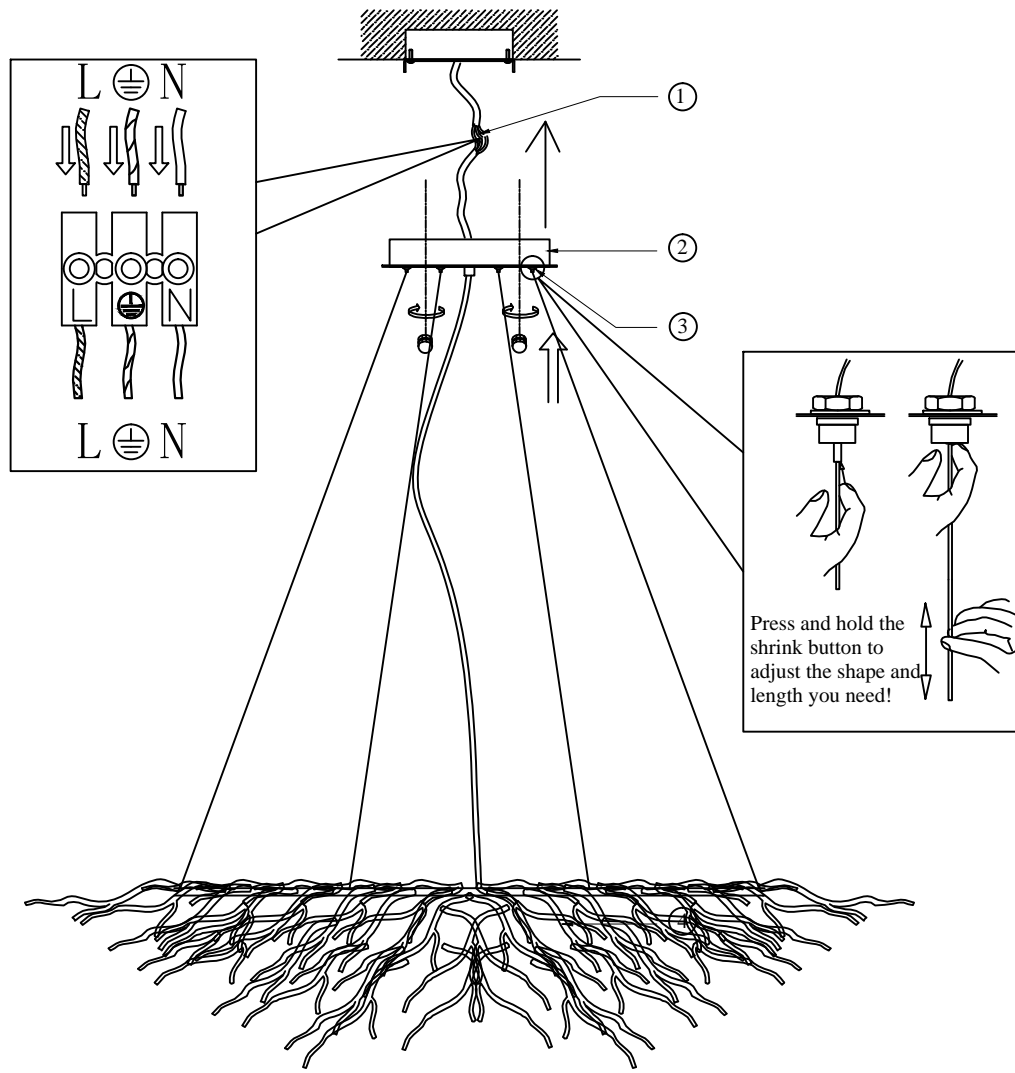

- ① Lift the installed lamp body to the bracket position and connect the wires, then lift it to align with the screw holes.
- ② Use the matching screws to tighten it.
- ③ Adjust the appropriate height of the lamp body according to the picture
- ④ Install the bulbs and test them.

Start debugging the lamp shape while ensuring the safety of personnel

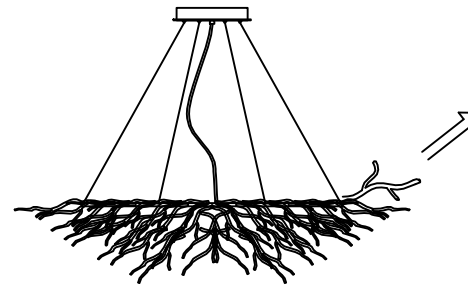

Tree branch adjustment diagram

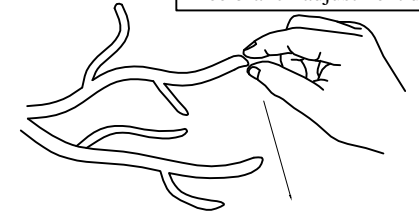

- Step.1: Swing the pole and lamp holder to achieve your desired effect.
- Step.2: Hold the branch with your hands and spread it out evenly.

Follow the steps above to adjust the effect as shown below (you can also adjust it the way you like)

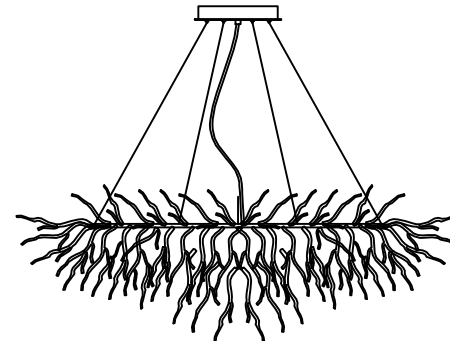

- ③ Adjust the branches to a satisfactory shape, as shown below, and start the next step of fixing the hanging ornaments (as shown below)

Hook in corresponding hole

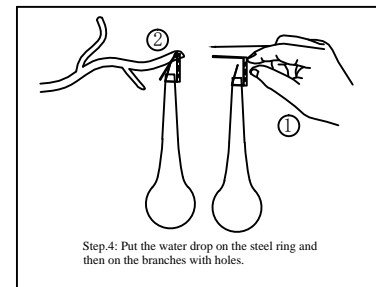

Step.4: Put the water drop on the steel ring and then on the branches with holes.

