

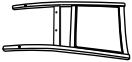

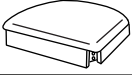









Assembly Instruction

UPHOLSTERED SIDE CHAIR

No	Parts List		Q'ty
A		Chair Back	1 Pce
B		Seat Assembly	1 Pce
C		Left Front Leg	1 Pce
D		Right Front Leg	1 Pce
E		Left Side Stretcher	1 Pce
F		Right Side Stretcher	1 Pce

No	Hardware List		Q'ty
1		8 x 1.1/4" Pan Head Screw	4 Pcs
2		M6x40mm JCBC Bolt	2 Pcs
3		M6x70mm JCBC Bolt	8 Pcs
4		M6x13mm Lock Washer	10 Pcs
5		M6.5x16.5mm Flat Washer	10 Pcs
6		M4x2.1/2" Allen Key	1 Pce
7		Assembly Glue	1 Pce

Important Note

Do not use power tool for assembly.
All bolt must fasten either by wrench or Allen Key.



STEP 2 Do not fully tighten the bolt

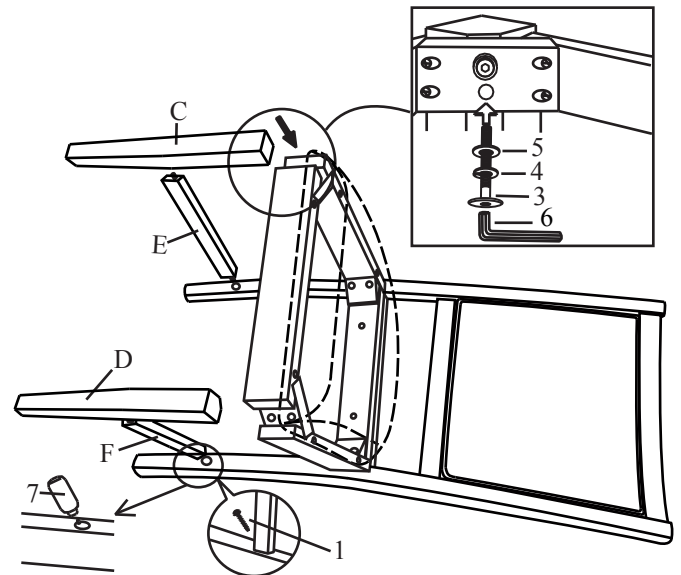

STEP 1 Do not fully tighten the bolt

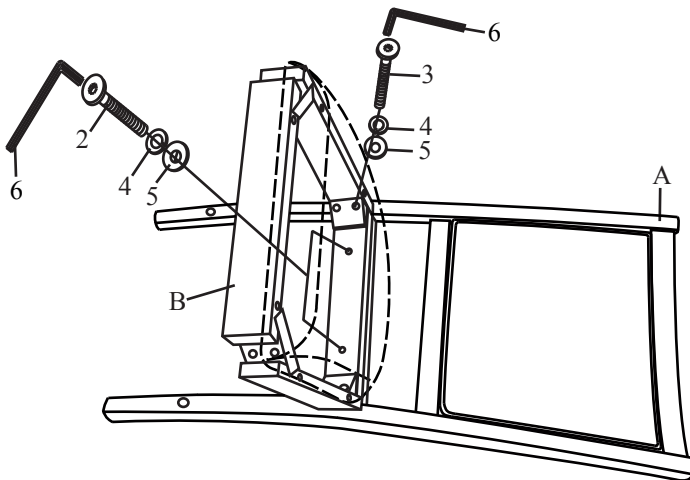

STEP 3

Levelling solution: Loosen each bolt in the seat box (front legs, back corner blocks and back apron) to the point where it can be turned with our fingers. Place the Chair upright on the floor and make sure Chair/Stool back and seat frame are well connected. Sit in the Chair/Stool, but do not lean against the Chair/Stool back. Gently sway back and forth, left and right. Carefully turn the Chair/Stool upside down, and tighten each bolt. The Chair/Stool will now be levelled.

