

ASSEMBLY INSTRUCTIONS

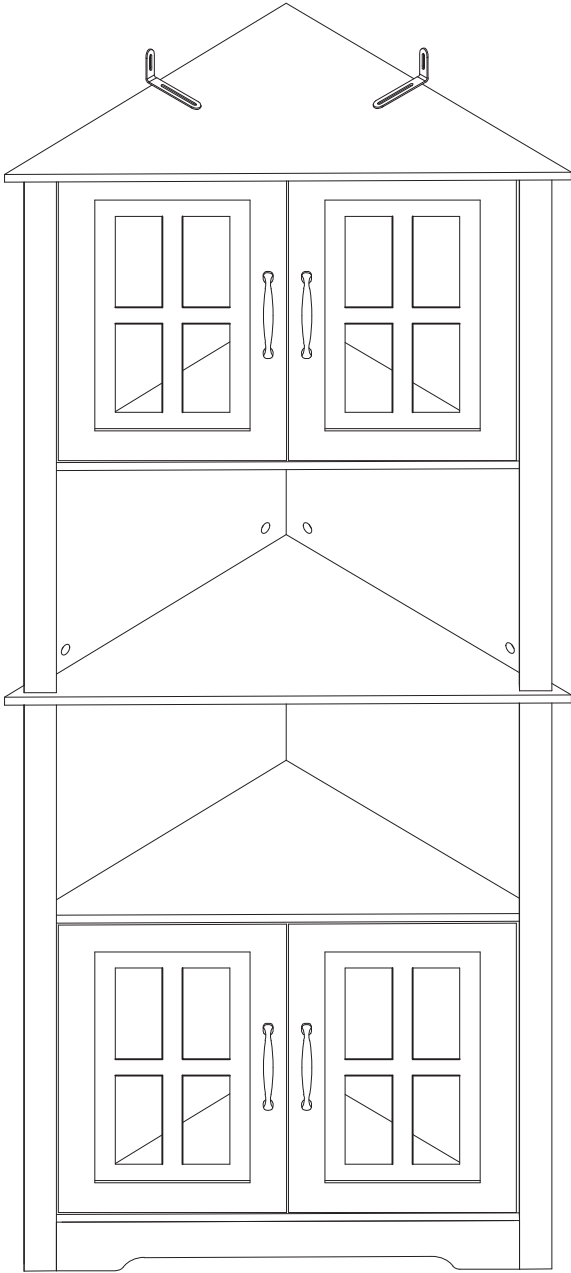

Before You Start

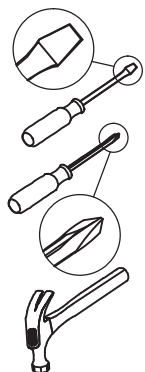

- ✓ Read through each step carefully and follow the proper order
- ✓ Separate and count all your parts and hardware
- ✓ Give yourself enough room for the assembly process
- ✓ Have the following tools: Flat Head Screwdriver, #2 Phillips Head Screwdriver and Hammer
- ✓ Caution: If using a power drill or power screwdriver for screwing, please be aware of to slow down and stop when screw is tight. Failure to do so may result in stripping the screw. (Assembly speed can be increased by using electric screwdriver)

Helpful Hints

PEOPLE NEEDED FOR ASSEMBLY: 1-2

- Open your item in the area you plan to keep it to avoid excessive heavy lifting.
- Identify, sort and count the parts before attempting assembly.
- Compression dowels are lightly tapped in with a hammer.
- Slides are labeled with an **R** (right) and **L** (left) for proper placement.
- Make sure to always face the point on the top of the Cam Lock towards the outer edge.
- If there is a back panel in the package, please install it to make sure your unit is complete and sturdy.
- Please fix all the screws provided for the back panel which can enhance product stability. If it is difficult to fix it when tightening, it can be fixed with the help of a hammer and then tightened.
- Do NOT use harsh chemicals or abrasive cleaners on this item.
- Never push, pull, or drag your furniture.





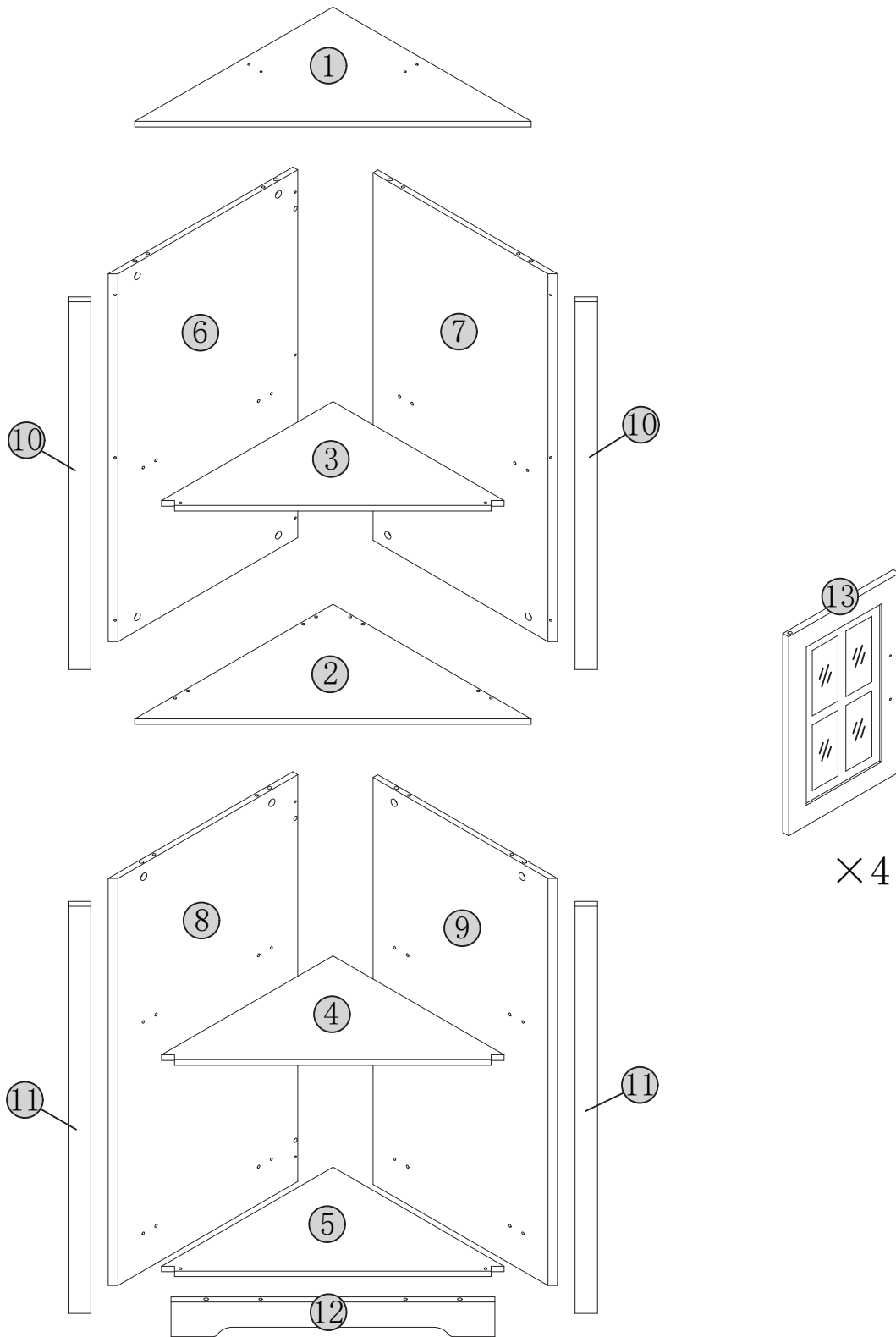

EXPLODED DRAWING:

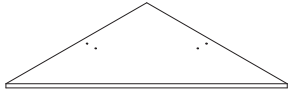
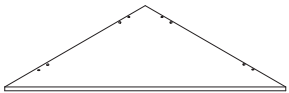
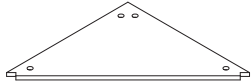
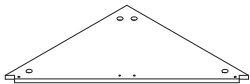
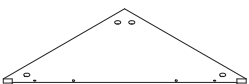
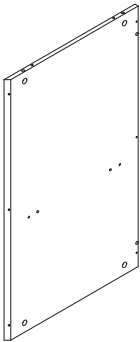
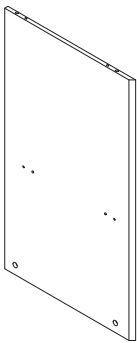

Board Identification

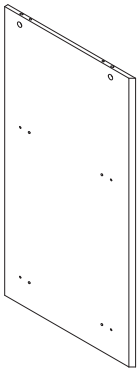
Not actual size

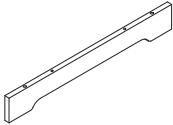
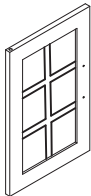
<p>①</p>  <p>1PC</p>	<p>②</p>  <p>1PC</p>	<p>③</p>  <p>1PC</p>
<p>④</p>  <p>1PC</p>	<p>⑤</p>  <p>1PC</p>	<p>⑥</p>  <p>1PC</p>
<p>⑦</p>  <p>1PC</p>	<p>⑧</p>  <p>1PC</p>	<p>⑨</p>  <p>1PC</p>
<p>⑩</p>  <p>2PCS</p>	<p>⑪</p>  <p>2PCS</p>	<p>⑫</p>  <p>1PC</p>
<p>⑬</p>  <p>4PCS</p>		

Part list

A × 26



B × 30

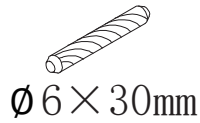

C × 26



D × 2

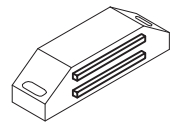

E × 4

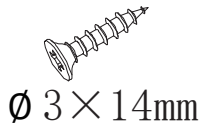

F × 6

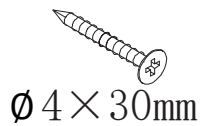

G × 14

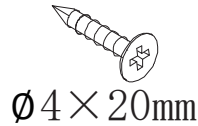

H × 8

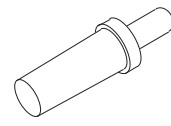

I × 4

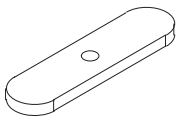

J × 4



K × 4

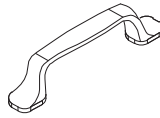

L × 8



M × 2

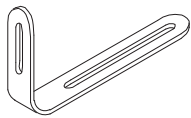

N × 4



O × 2

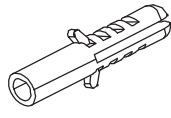

P × 2

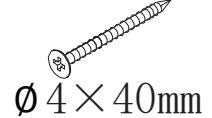

SPECIAL TIPS FOR FITTING CAM-LOCKS AND QUICKFIT

**WHEN FITTING CAMLOCK
ENSURE STARTING POSITION IS CORRECT
BEFORE YOU INSERT CONNECTING QUICKFIT
TURN CLOCKWISE UNTIL SECURE**



↑
CORRECT



WRONG

CAM-LOCK

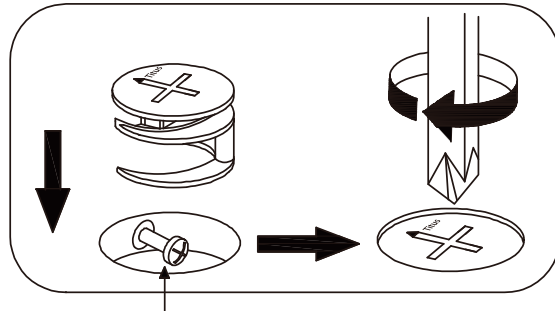

Quickfit head needs to be in centre

QUICKFIT

Tighten until shoulder is flush with panel. DO not overtighten or undertighten (see example below)

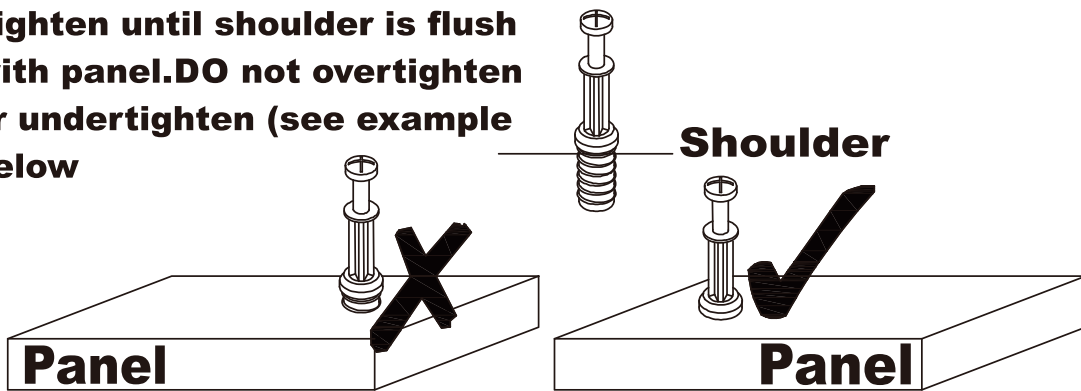

Cam Lock Fastening System

Insert the cam bolt into the hole first, then insert the cam lock and lock it.

1

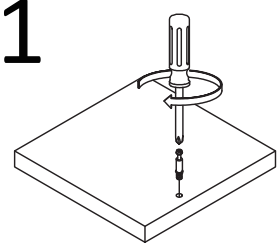

2

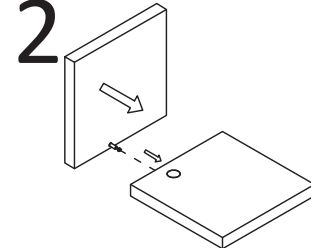

3

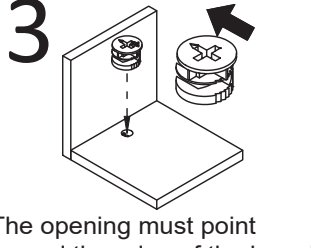



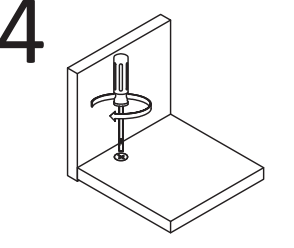

The opening must point toward the edge of the board

4

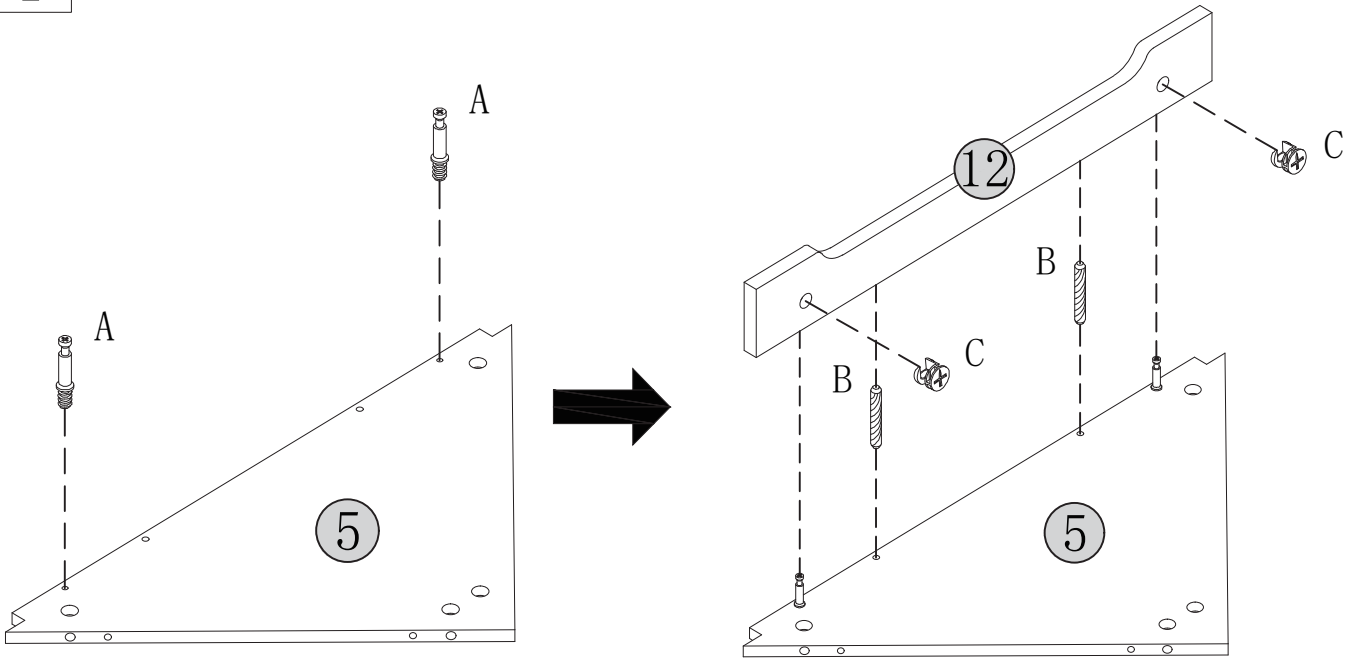



1

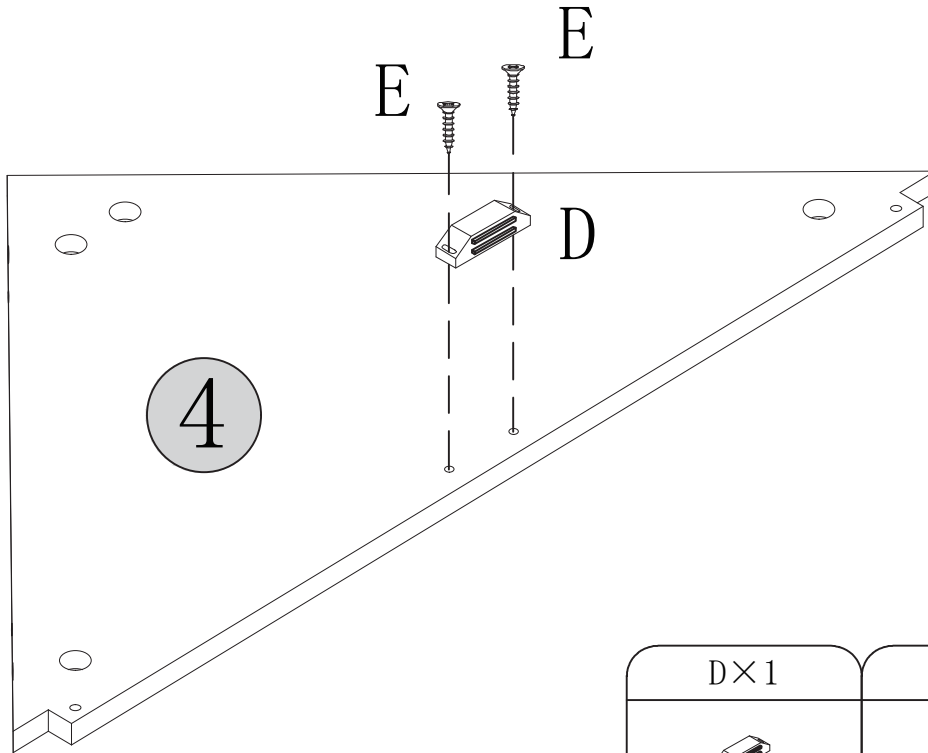

A×2	B×2	C×2
		
Ø 6×35mm	Ø 6×30mm	Ø 15×10mm

2



D×1	E×2
	
	Ø 3×14mm

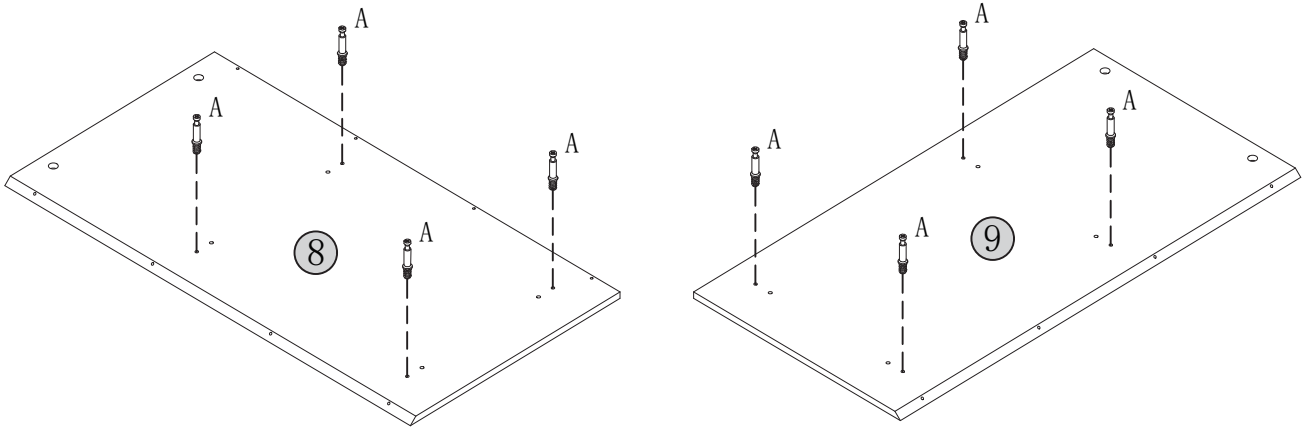

3

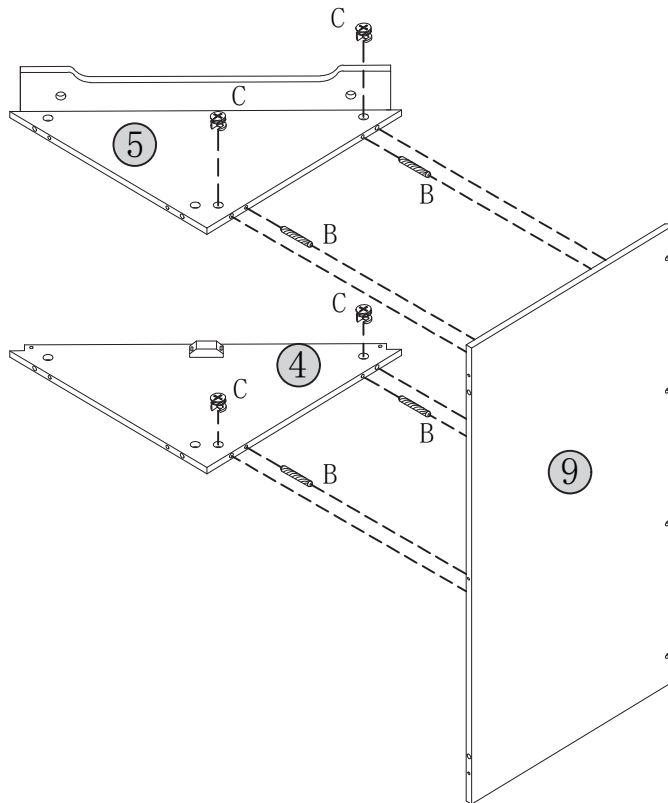

A×8

∅6×35mm



4

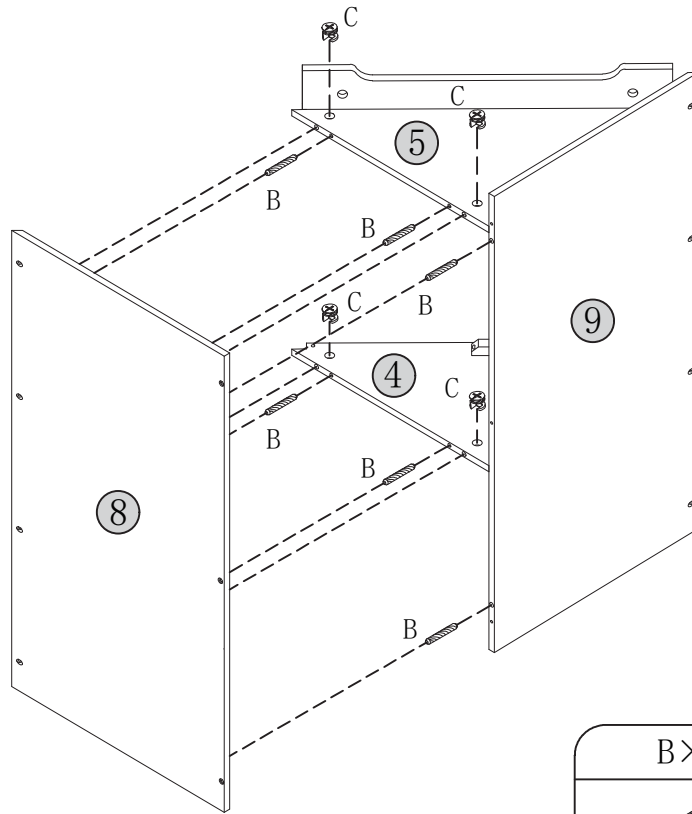

B×4	C×4
	
∅6×30mm	∅15×10mm

5



B×6	C×4
	
φ6×30mm	φ15×10mm

6

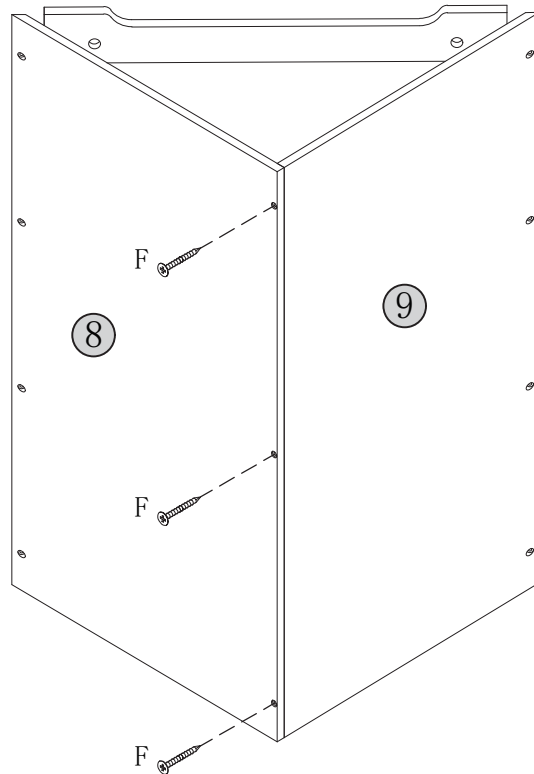

F×3

φ4×30mm

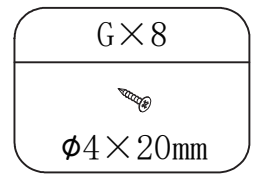
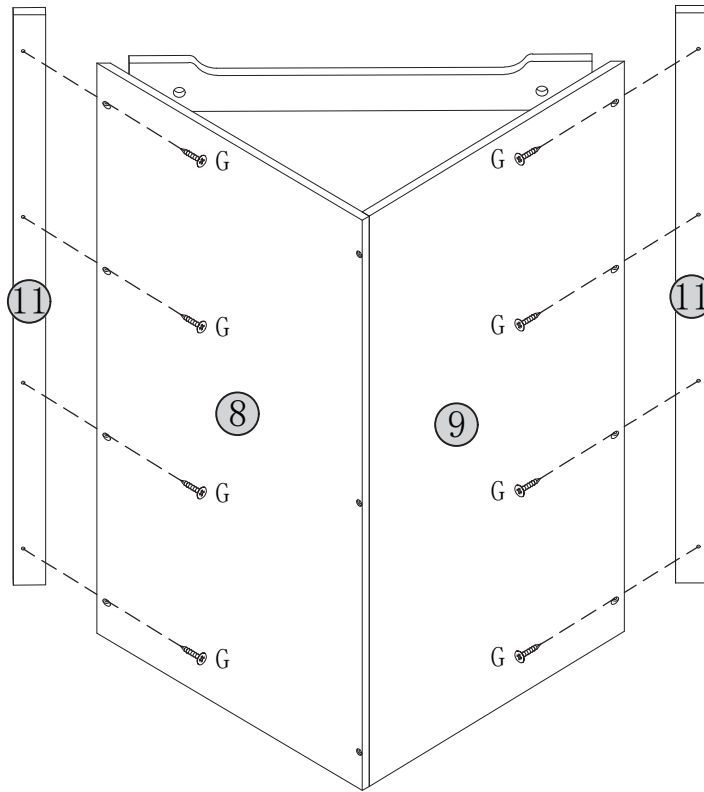
7

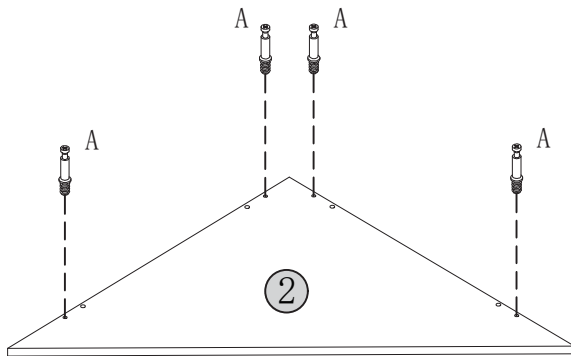

8



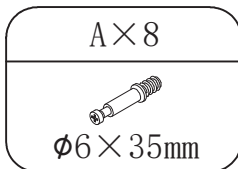
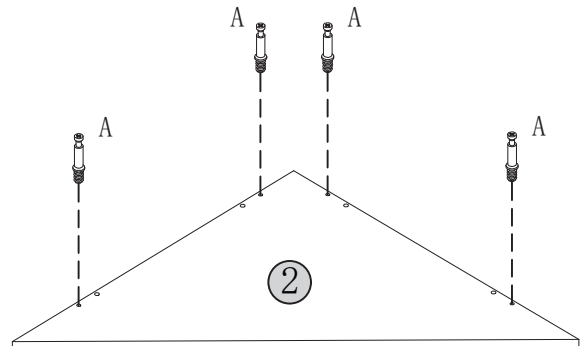

180°

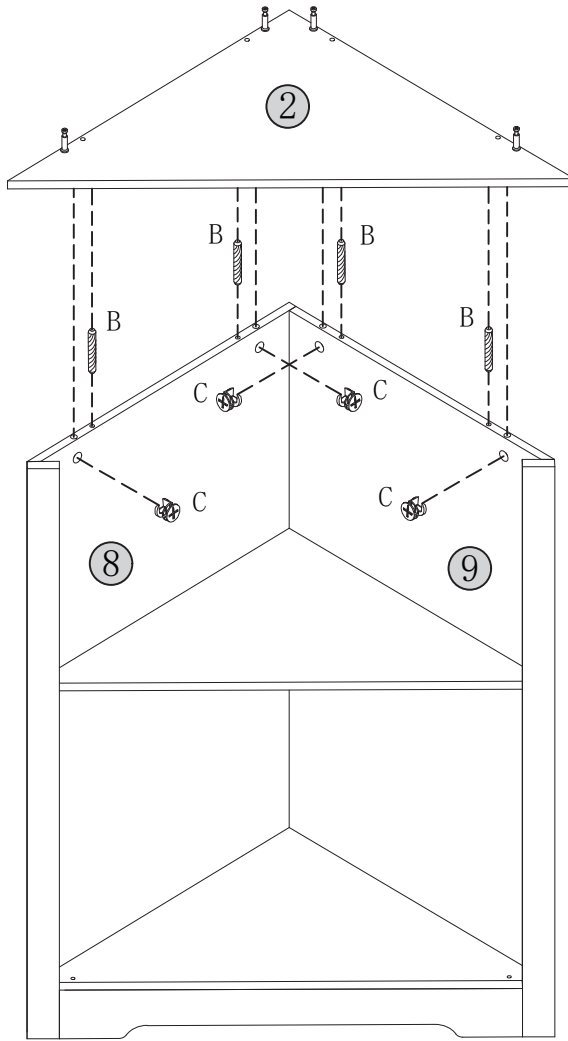

9

9



B × 4	C × 4
	
φ6 × 30mm	φ15 × 10mm

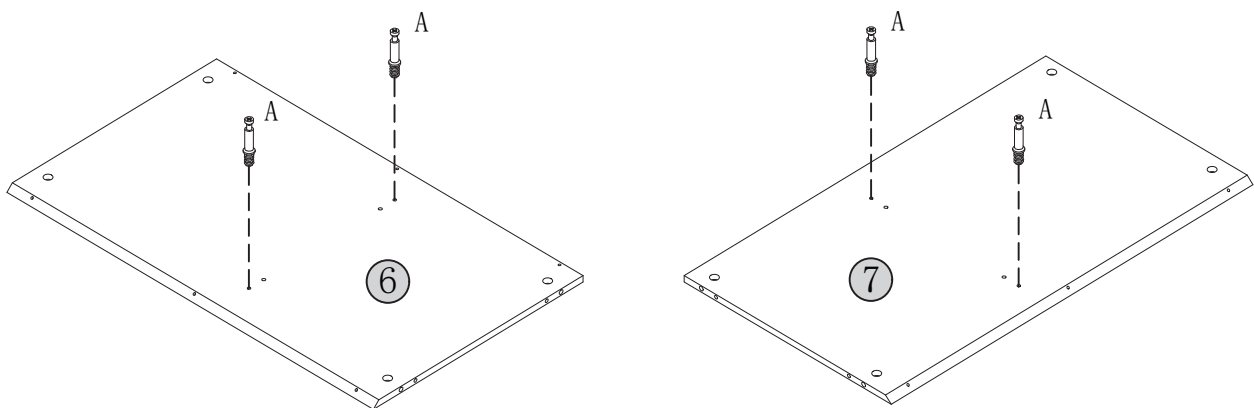

10

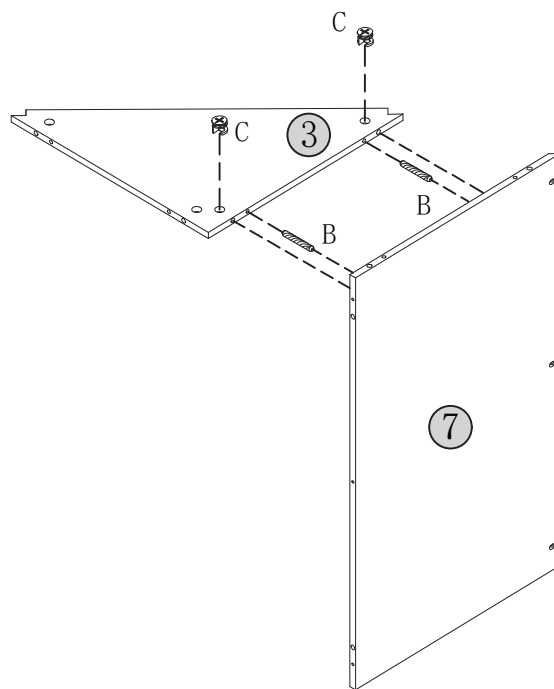

A × 4

φ6 × 35mm



11

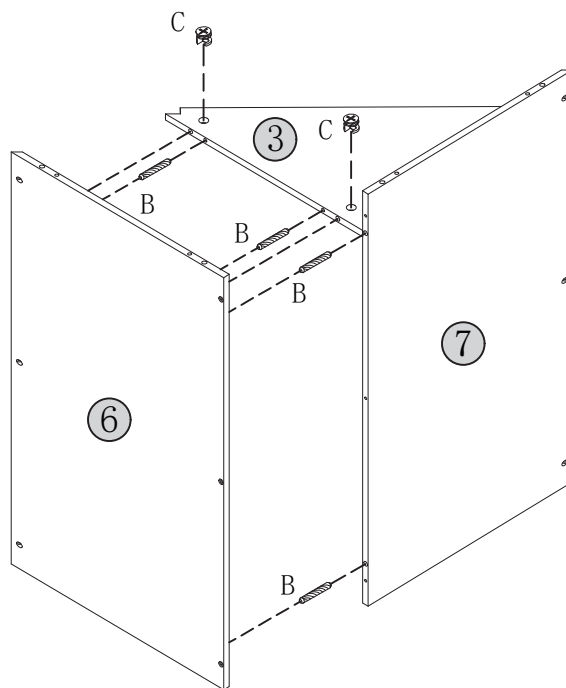

B×2	C×2
	
φ6×30mm	φ15×10mm

12



B×4	C×2
	
φ6×30mm	φ15×10mm

13

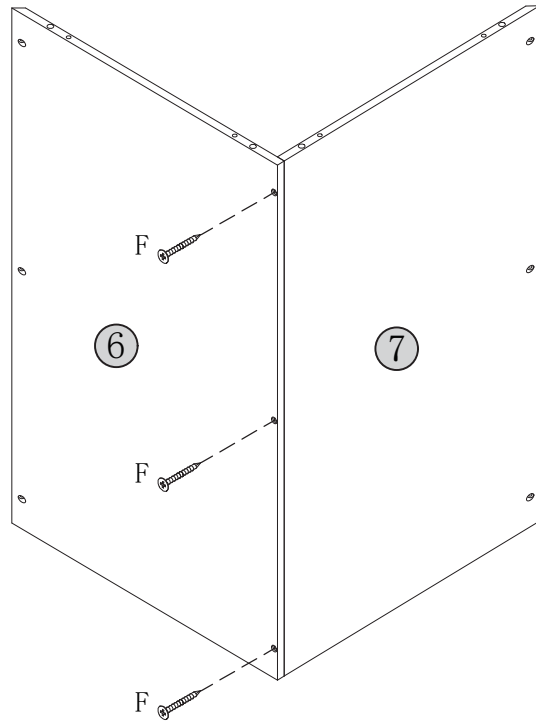

F × 3

Ø 4 × 30mm

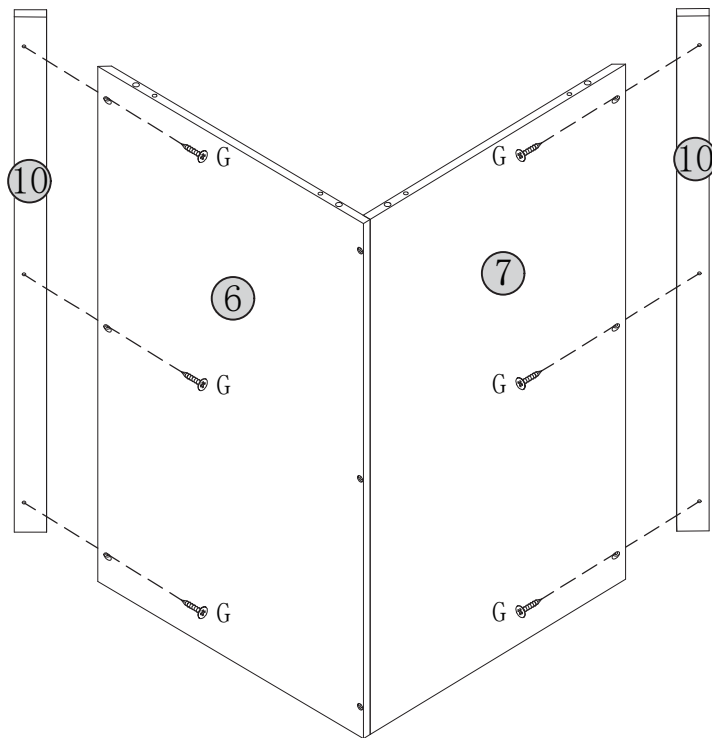

14

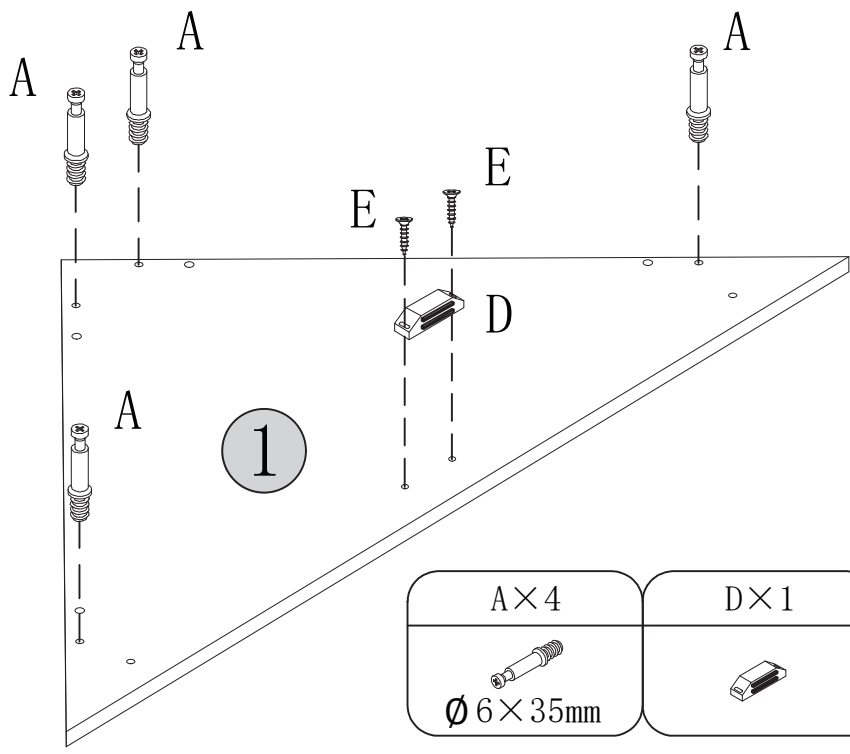

G × 6

Ø 4 × 20mm



15



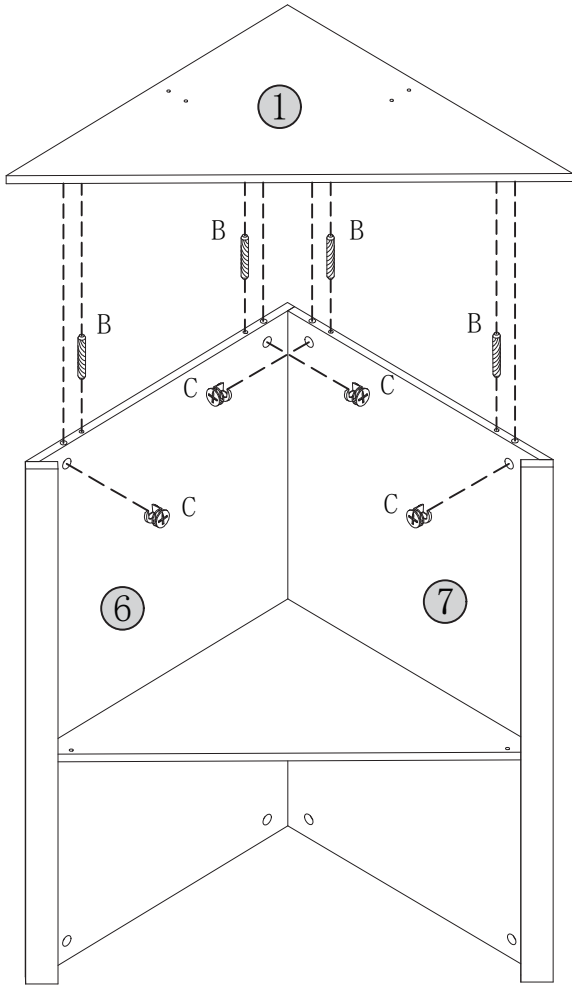

A × 4	D × 1	E × 2
 Ø 6 × 35mm		 Ø 3 × 14mm

16

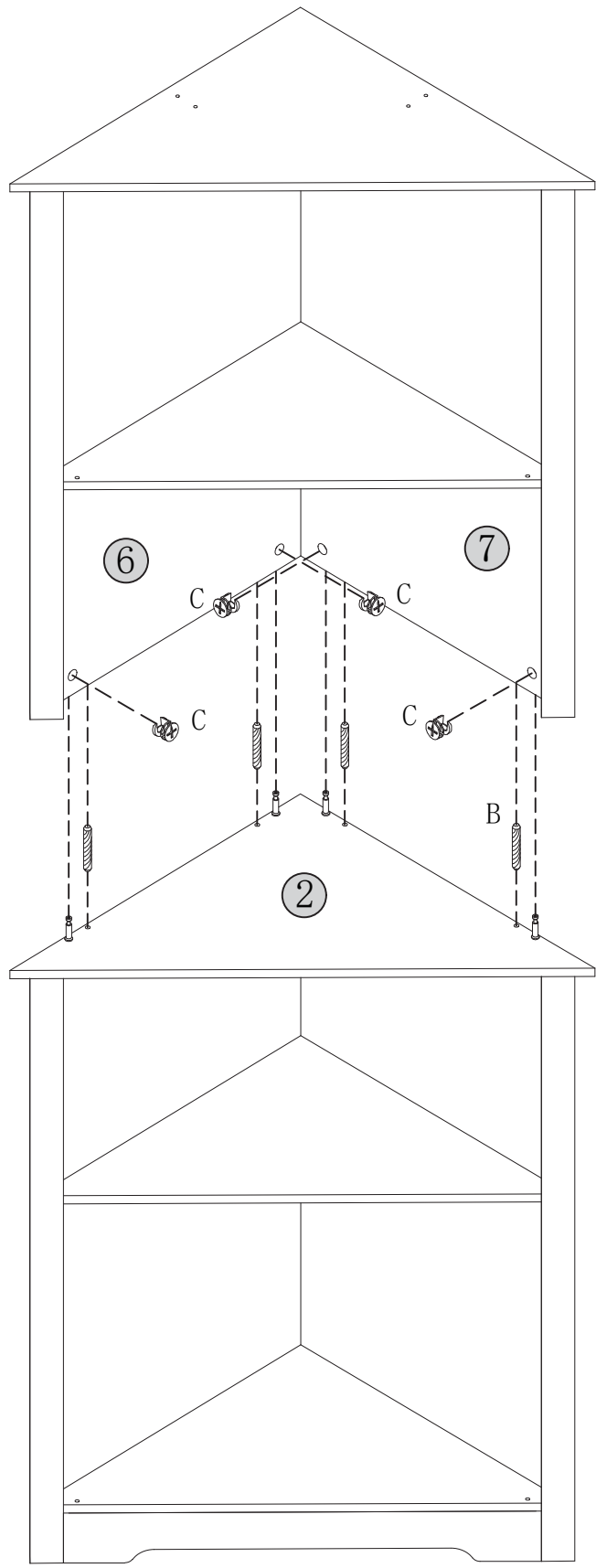

B × 4	C × 4
 Ø 6 × 30mm	 Ø 15 × 10mm



B×4	C×4
	
Ø 6×30mm	Ø 15×10mm

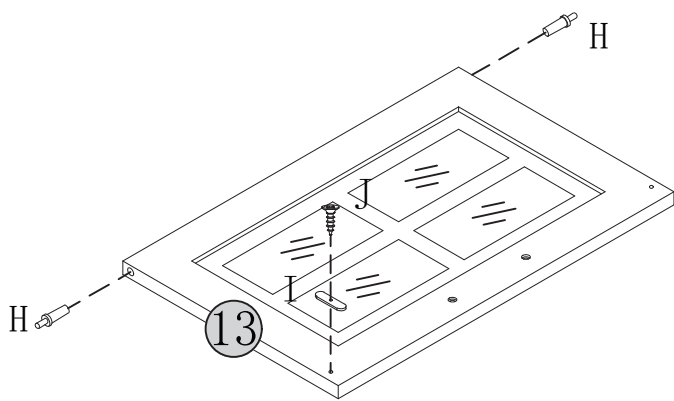

18

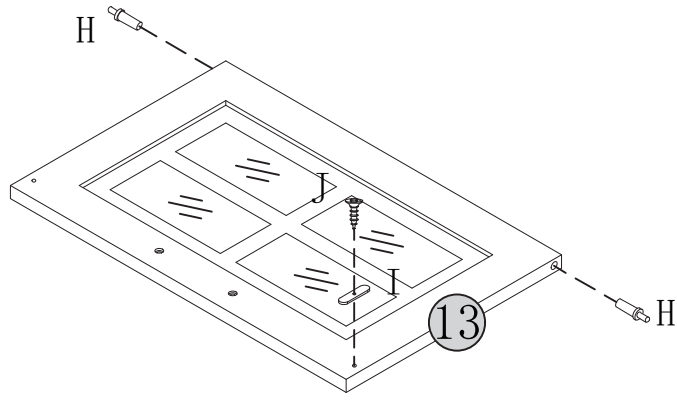

×2



×2

H×8	I×4	J×4
		
		Ø 3×12mm

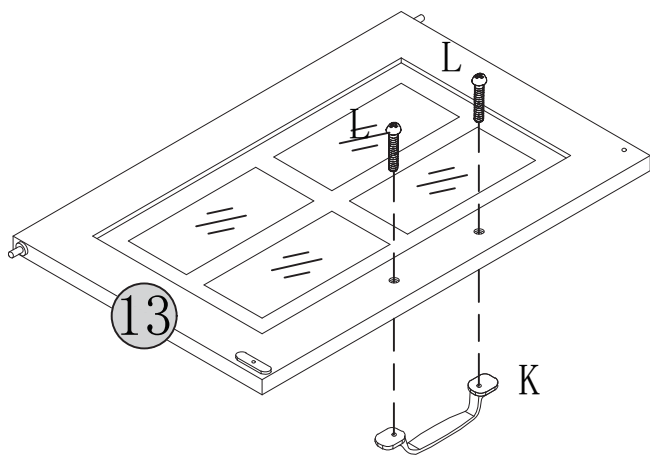

19

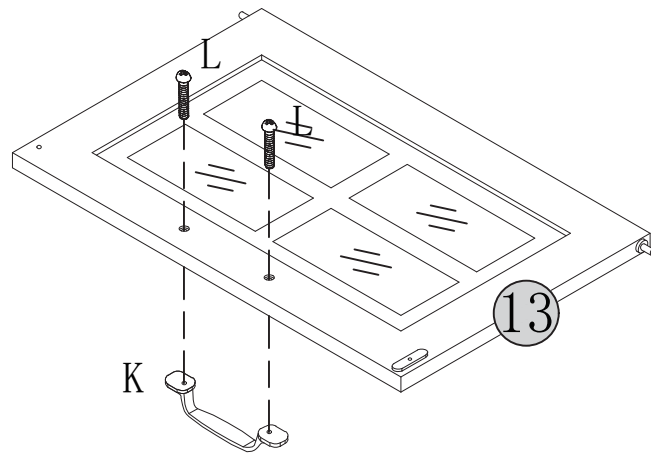

×2





×2

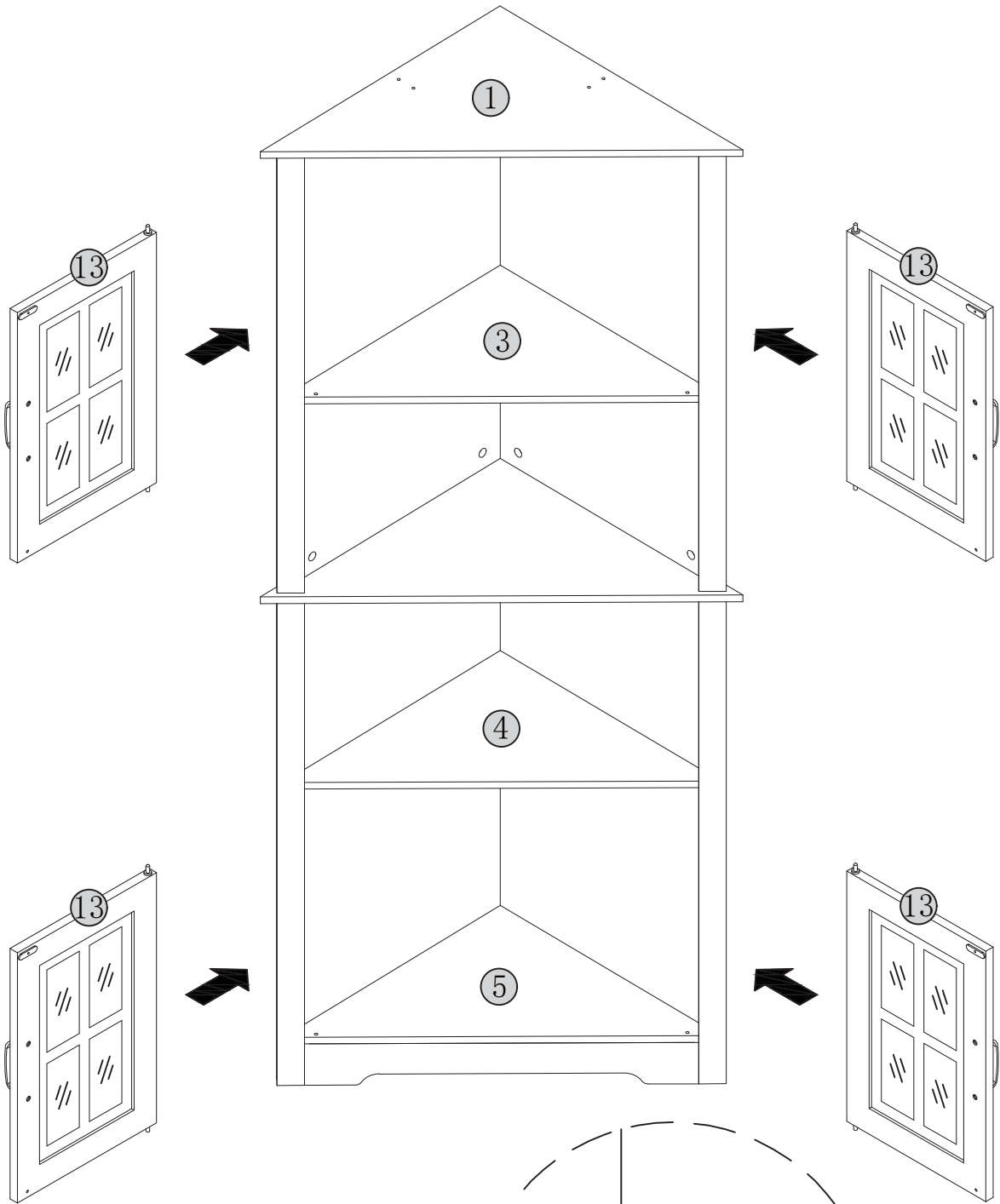

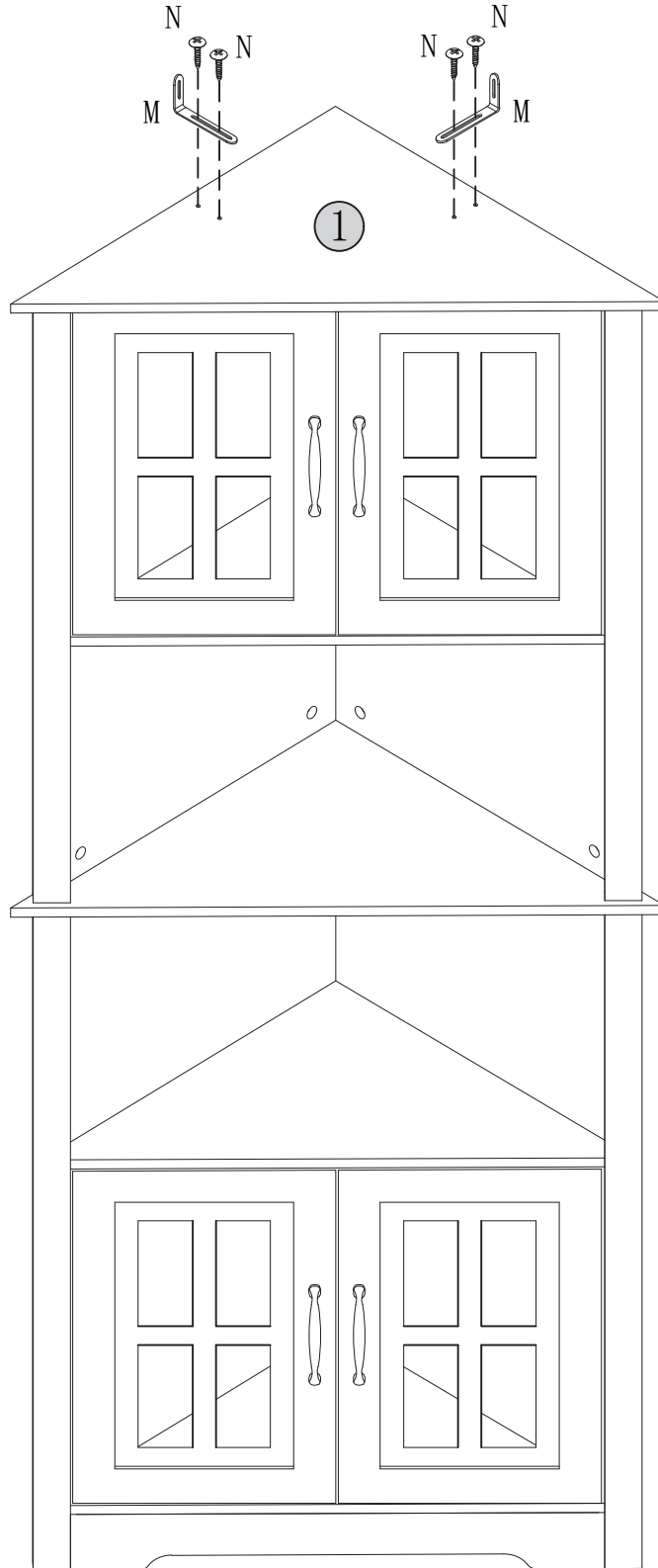
K×4	L×8
	
	Ø 4×18mm



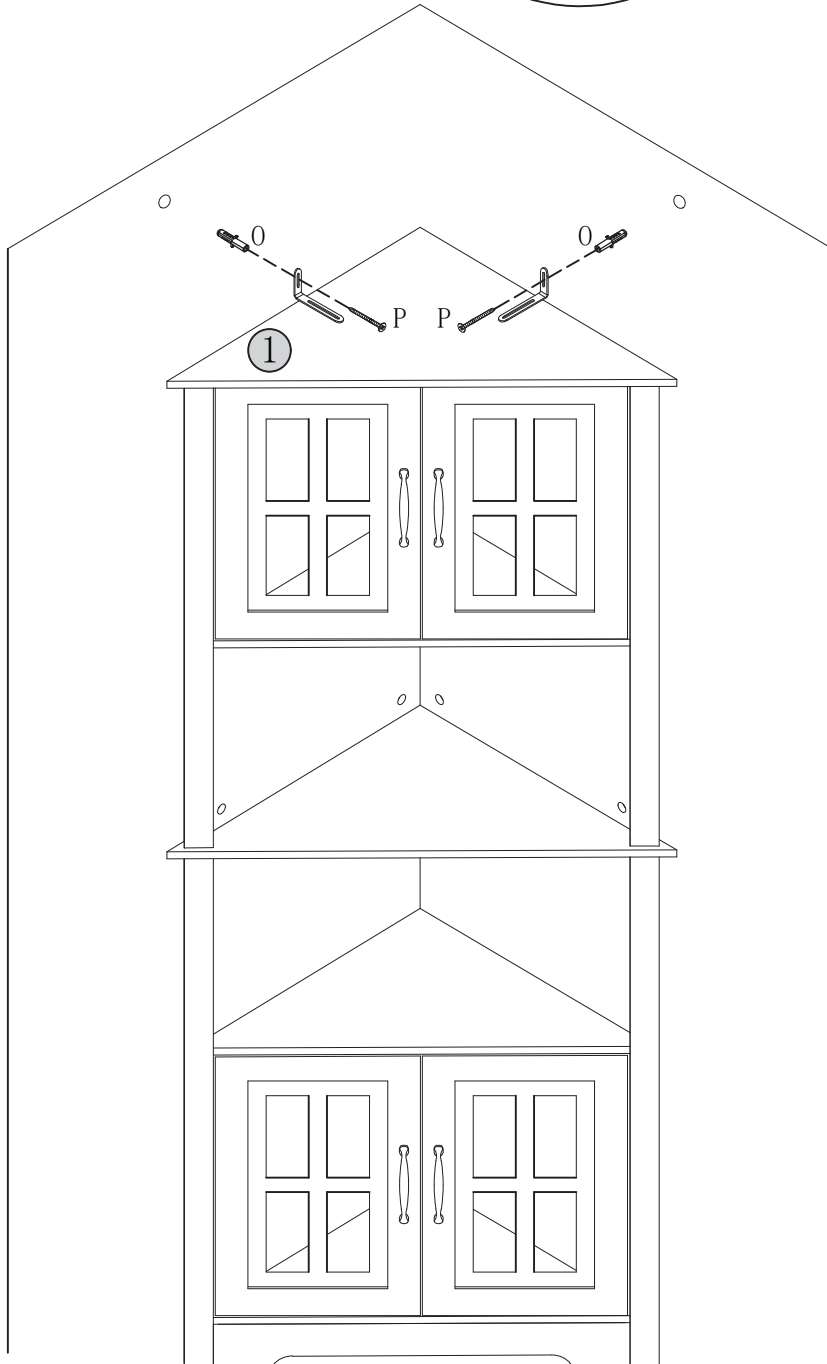
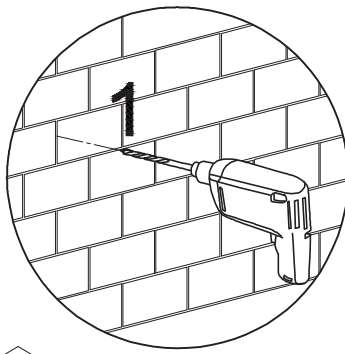

M × 2	N × 4
	 Ø 4 × 14mm



0×2	P×2
	
	Ø 4×40mm