

ASSEMBLY INSTRUCTION

Dimension: 18.5"x21"x38"H



CUBE SIZE: 39.5"x17.5"x10.3"

Description: Dudley Dining Chair With Wood Seat

NW: 33 LBS



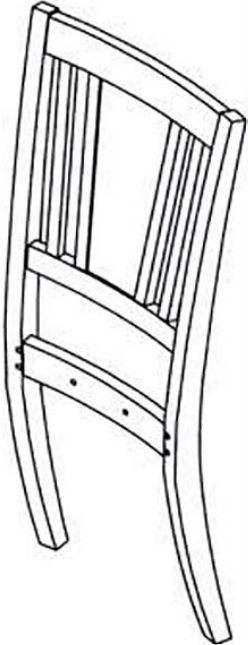
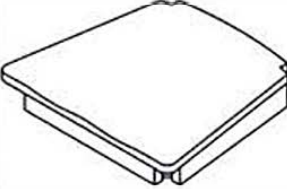

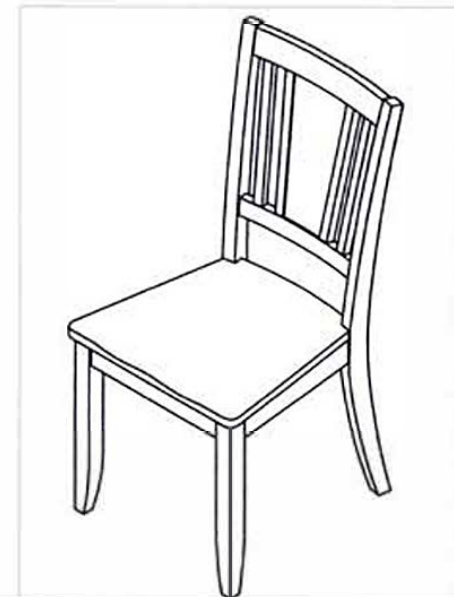
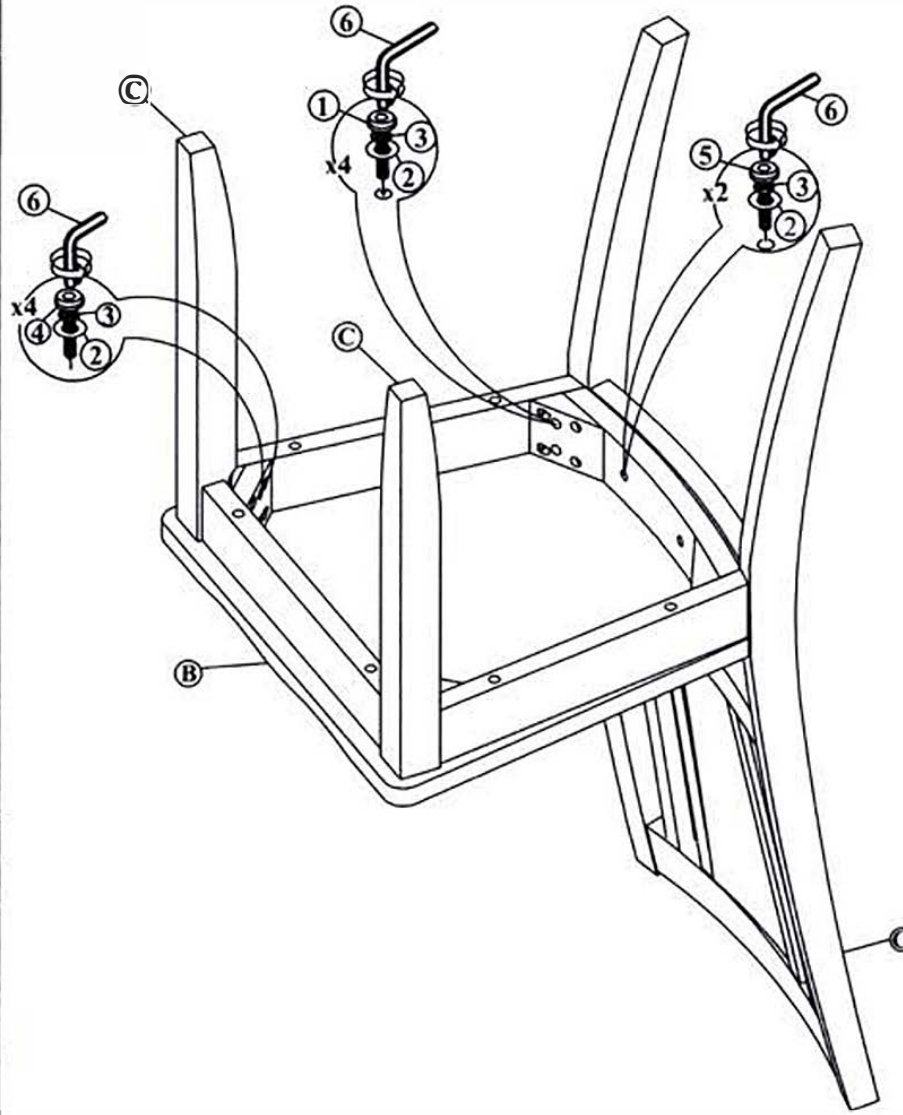

GW: 37.4 LBS

LIST OF PARTS

<p>A CHAIR BACK FRAMER</p>  <p>1 PC</p>	<p>B CUSHION SEAT</p>  <p>1 PC</p> <p>C FRONT LEGS (L-R)</p>  <p>2 PCS</p>
---	---



LIST OF HARDWARE

<p>1 LONG JCBIC BOLT</p>  <p>M6x70 4 PCS</p>	<p>2 FLAT WASHER</p>  <p>Ø16x16 18 PCS</p>	<p>3 LOCK WASHER</p>  <p>Ø16x19 18 PCS</p>
<p>4 MEDIUM JCBIC BOLT</p>  <p>M6x60 4 PCS</p>	<p>5 SHORT JCBIC BOLT</p>  <p>M6x40MM 2 PCS</p>	<p>6 ALLEN KEY</p>  <p>M4 1 PC</p>