

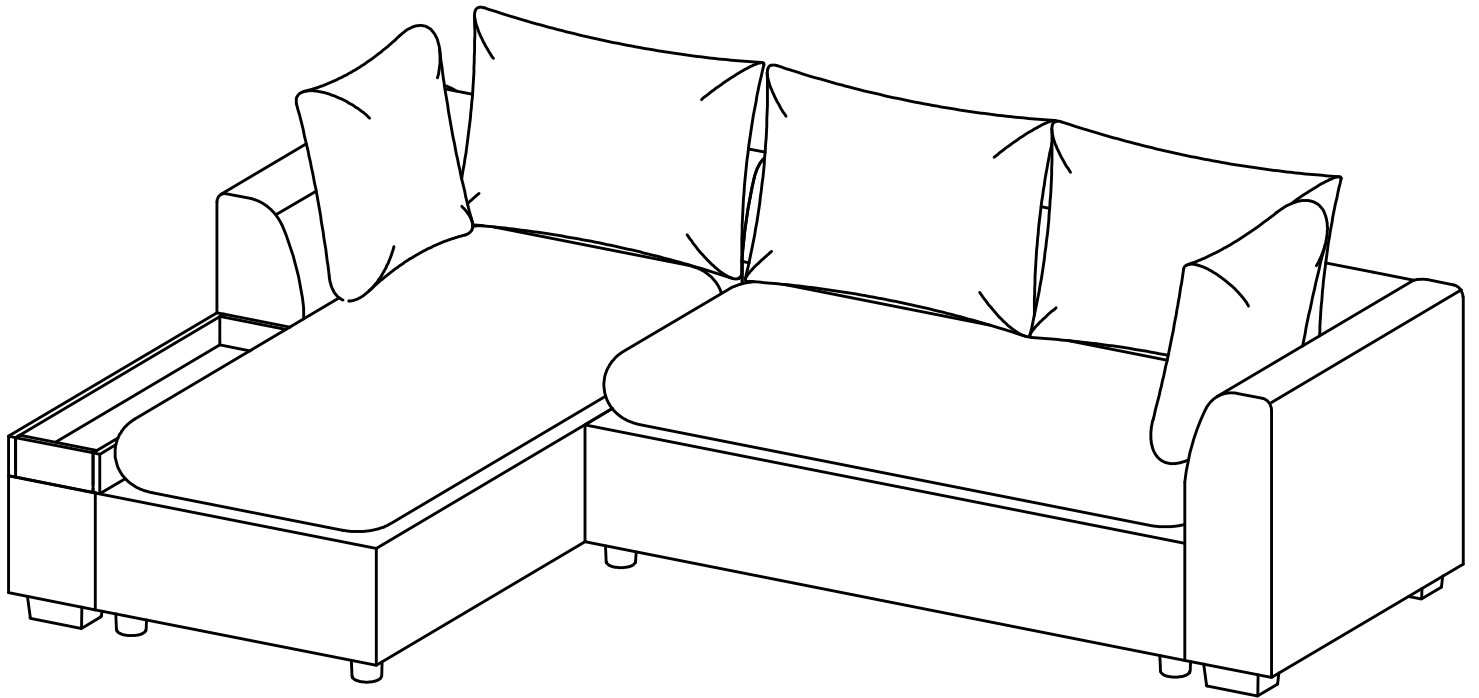

ASSEMBLY INSTRUCTION

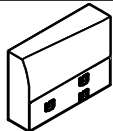

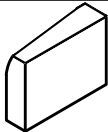
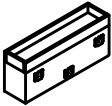

ITEM NO.: N719P272830 - N719P272831 - N719P272832

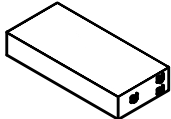
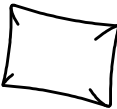
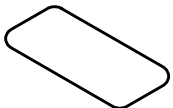

N719P272830 - COMPONENT LIST

NO.	DRAWING	QTY	DESCRIPTION
(A)		1	Left Arm
(B)		1	Right Arm
(C)		1	Arm
(D)		2	Pillow

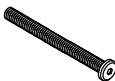
N719P272831 - COMPONENT LIST

NO.	DRAWING	QTY	DESCRIPTION
(E)		1	Chaise Backrest
(F)		1	Loveseat Body
(G)		3	Back Cushion
(H)		1	Loveseat Cushion
(I)		6	Square Legs
(J)		6	Round Legs
(K)		22	Bolt 5/16" x 50mm
(L)		10	Flat Washer Ø8 5/16"
(M)		1	Allen Key

N719P272832 - COMPONENT LIST

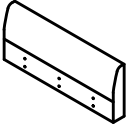
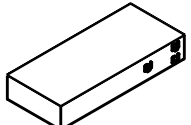
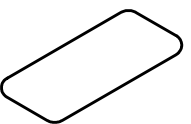
NO.	DRAWING	QTY	DESCRIPTION
Ⓝ		1	Loveseat Backrest
Ⓞ		1	Chaise Body
Ⓟ		1	Chaise Cushion

* Take out the ⓐ ⓑ ⓒ ⓓ

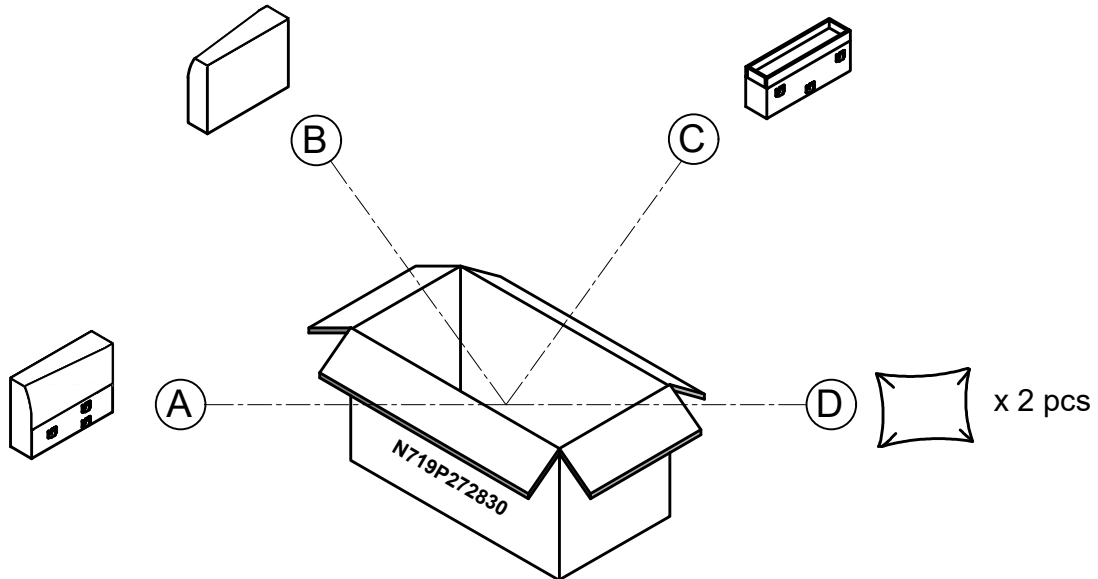



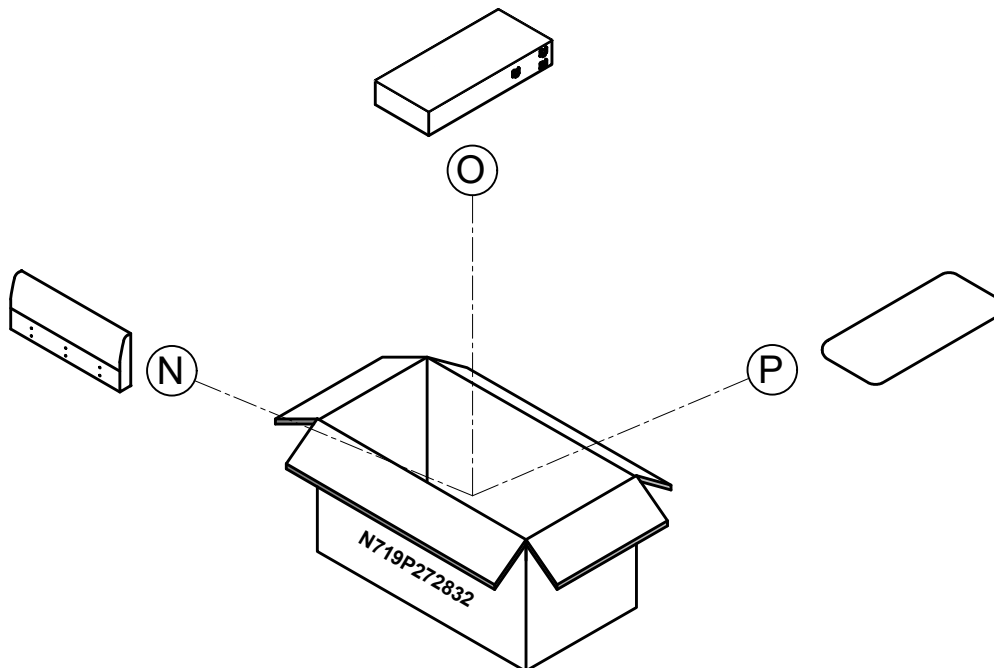



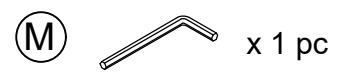
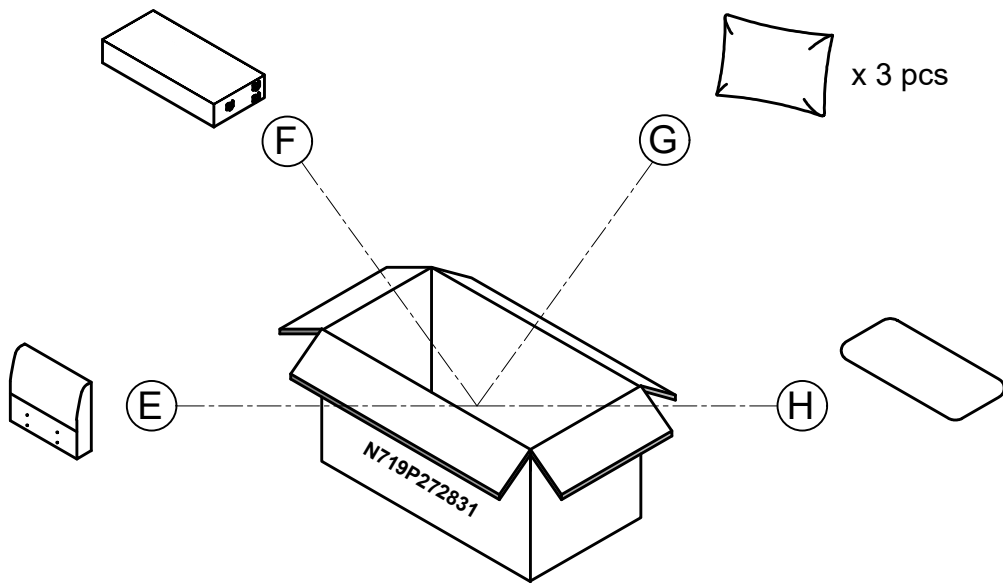

* Take out the Ⓝ Ⓞ Ⓟ

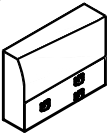
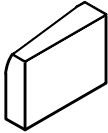
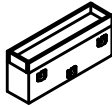

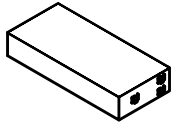
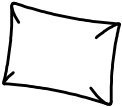
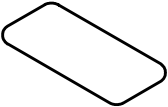
* Take out the (E) (F) (G) (H) (I) (J) (K) (L) (M)

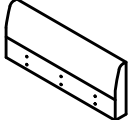
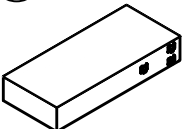
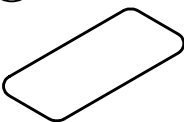

PARTS LIST

(A) 	(B) 	(C) 	(D) 	(E) 	(F) 	(G) 
Left Arm x 1 pc	Right Arm x 1 pc	Arm x 1 pc	Pillow x 2 pcs	Chaise Backrest x 1 pc	Loveseat Body x 1 pc	Back Cushion x 3 pcs
(H) 	(I) 	(J) 	(K) 	(L) 	(M) 	(N) 
Loveseat Cushion x 1 pc	Square Legs x 6 pcs	Round Legs x 6 pcs	Bolt 5/16" x 50mm x 22 pcs	Flat Washer Ø8 5/16" x 10 pcs	Allen Key x 1 pc	Loveseat Backrest x 1 pc
(O) 	(P) 					
Chaise Body x 1 pc	Chaise Cushion x 1 pc					

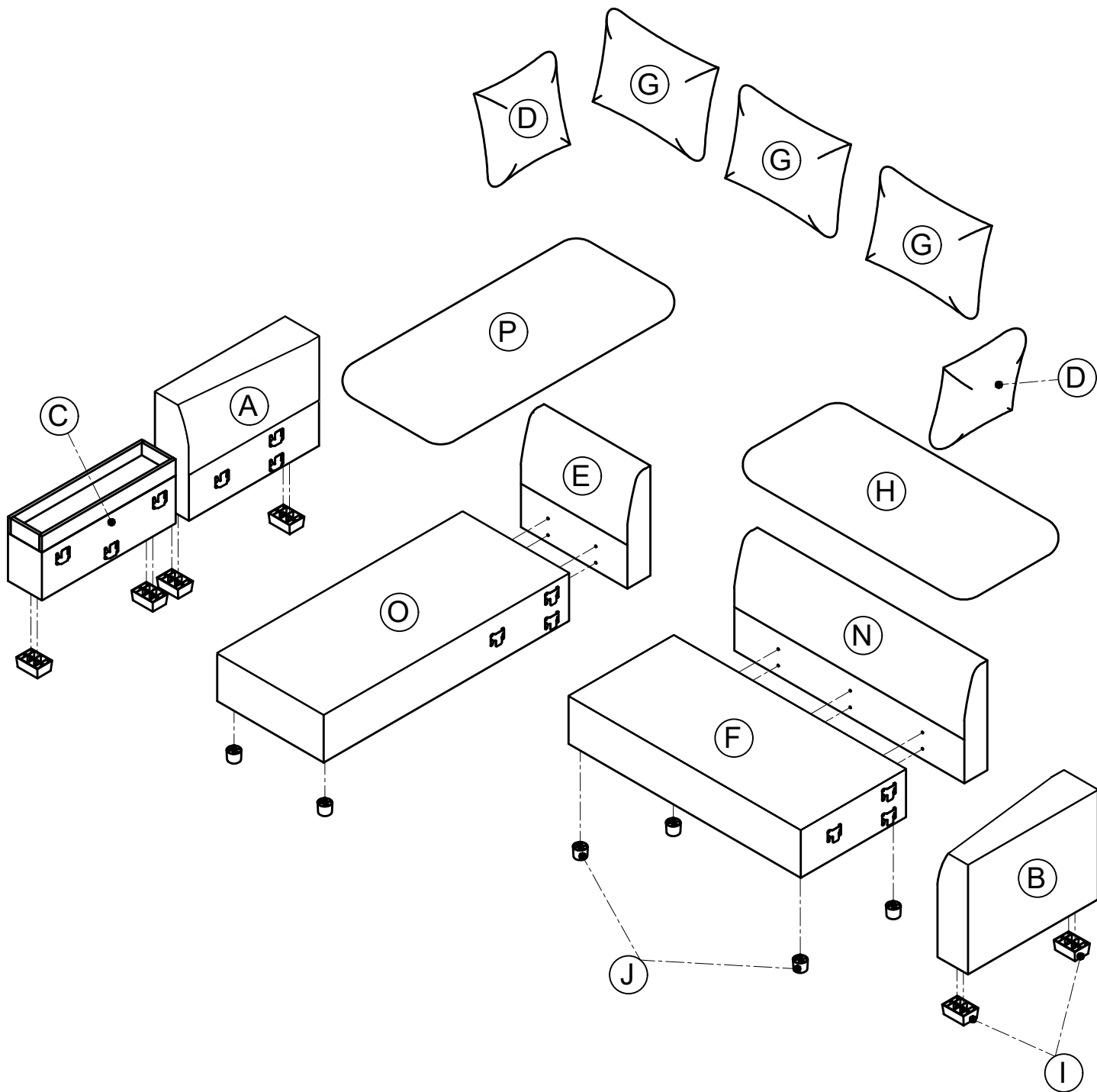

STEP 1:

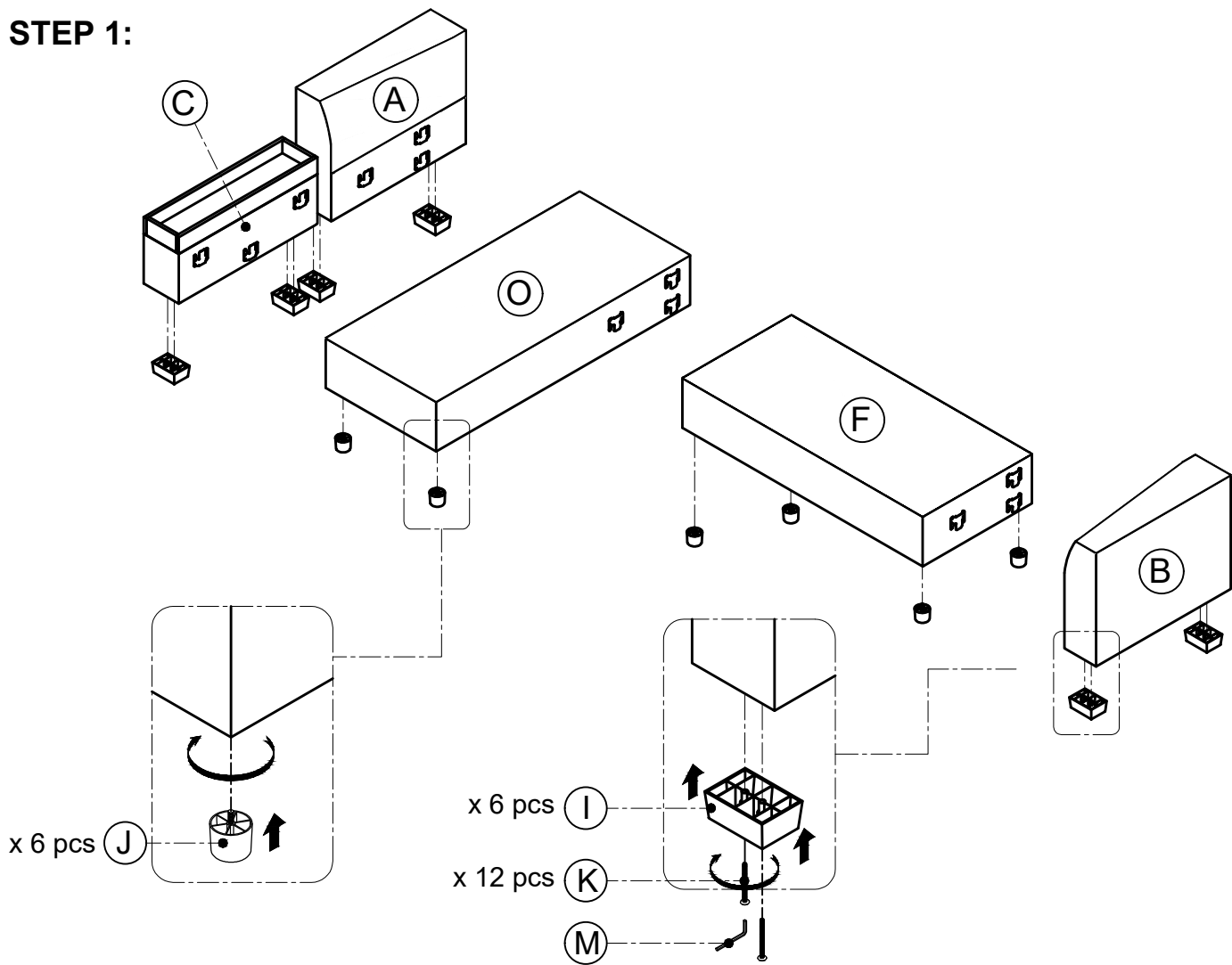

STEP 2:

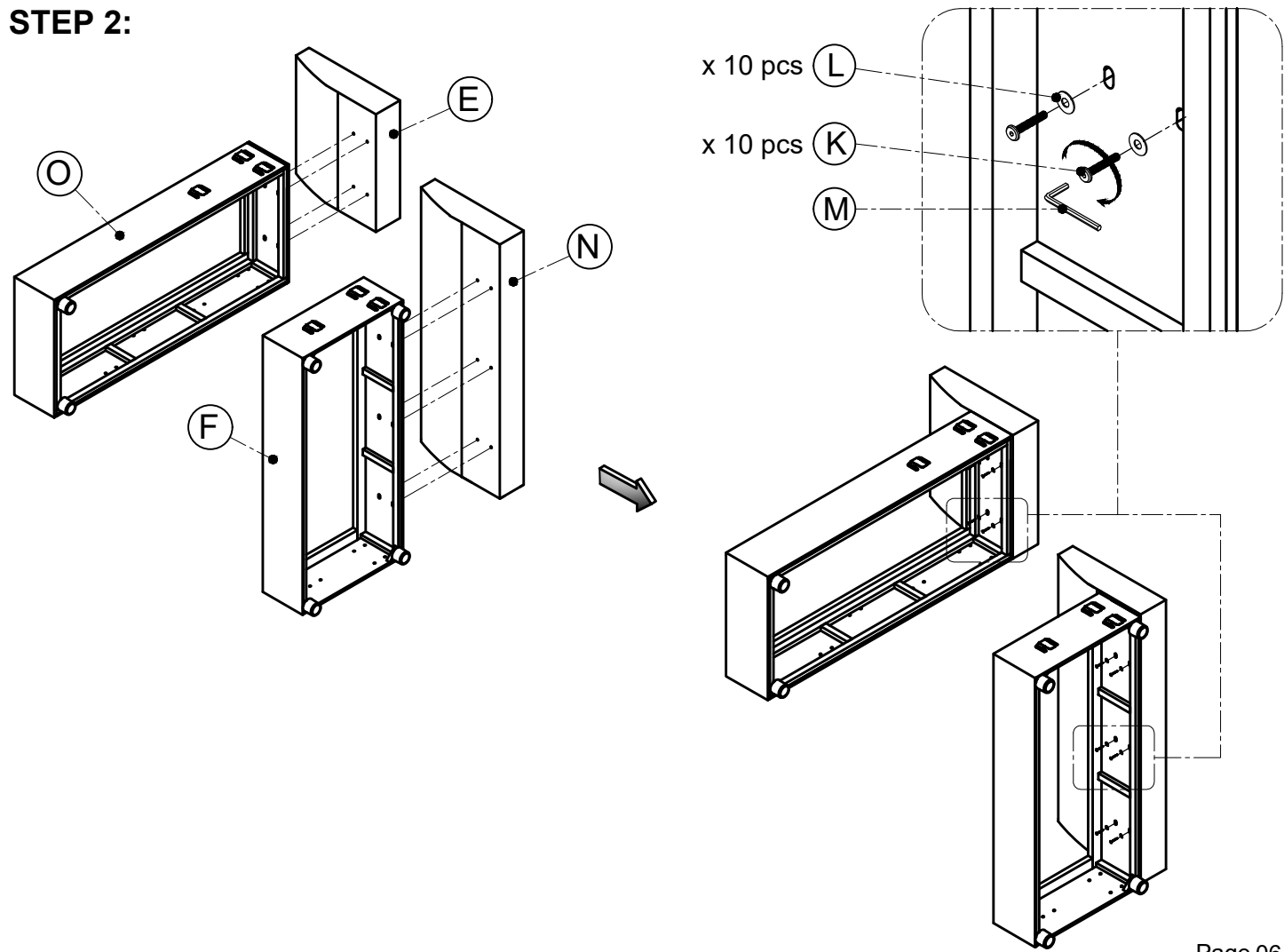

STEP 3:

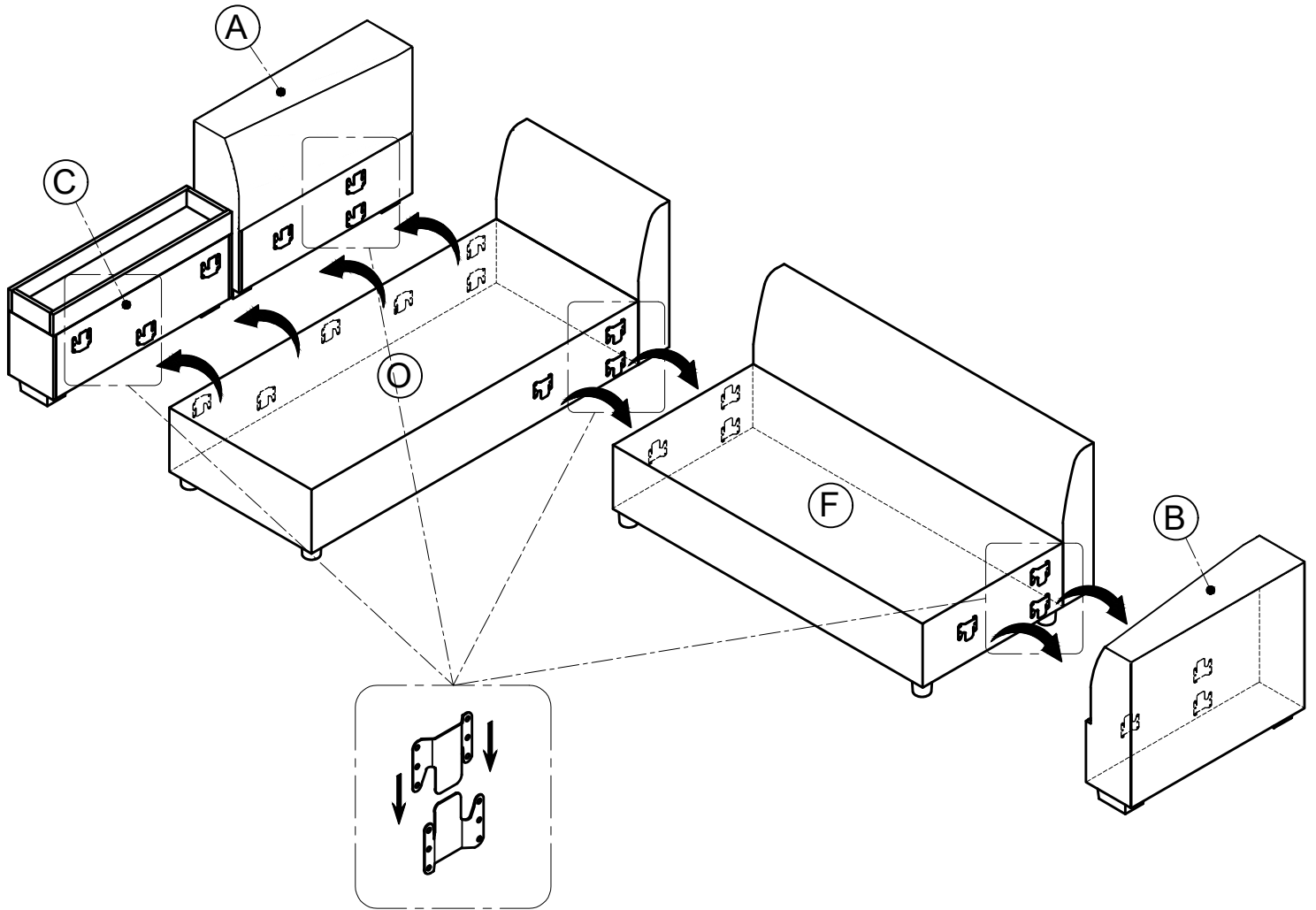

Helpful Hints

- Sofa bed can transform into a sleeper.
- Move your new furniture carefully, with two people lifting and carrying the unit to its new location.
- Your furniture can be disassembled and reassembled to move.
- Clean the product with a soft damp cloth. DO NOT use harsh chemicals or abrasive cleaners.

COMPLETED

