

ASSEMBLY INSTRUCTION

Dining table

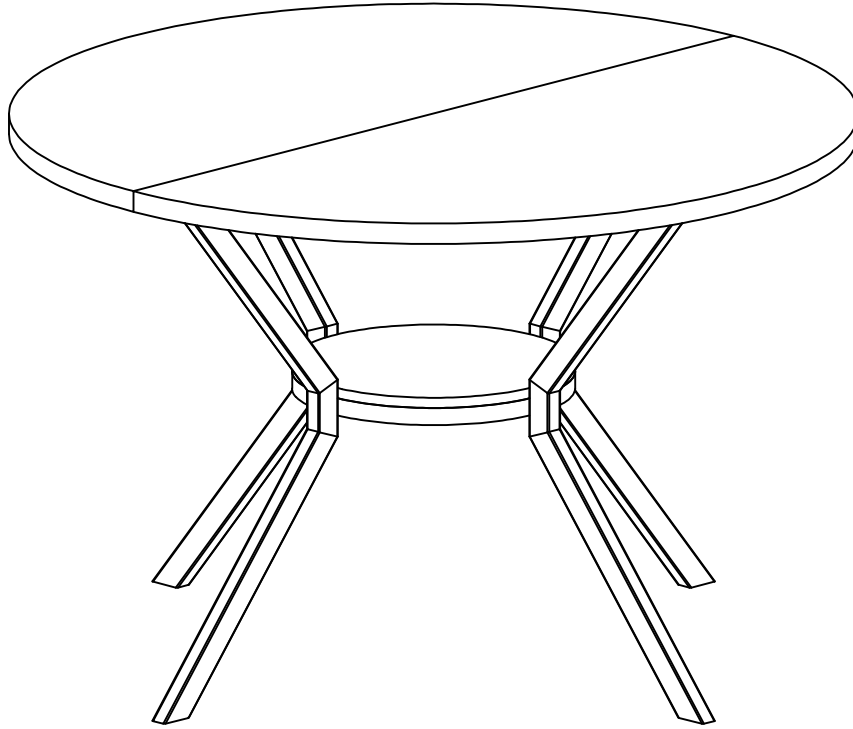

Dear customer,

Thank you for your support. If you have any questions or concerns, please don't hesitate to contact us. Our customer service team is always here to help and assist you in any way we can. Thank you again for choosing our Dining table.

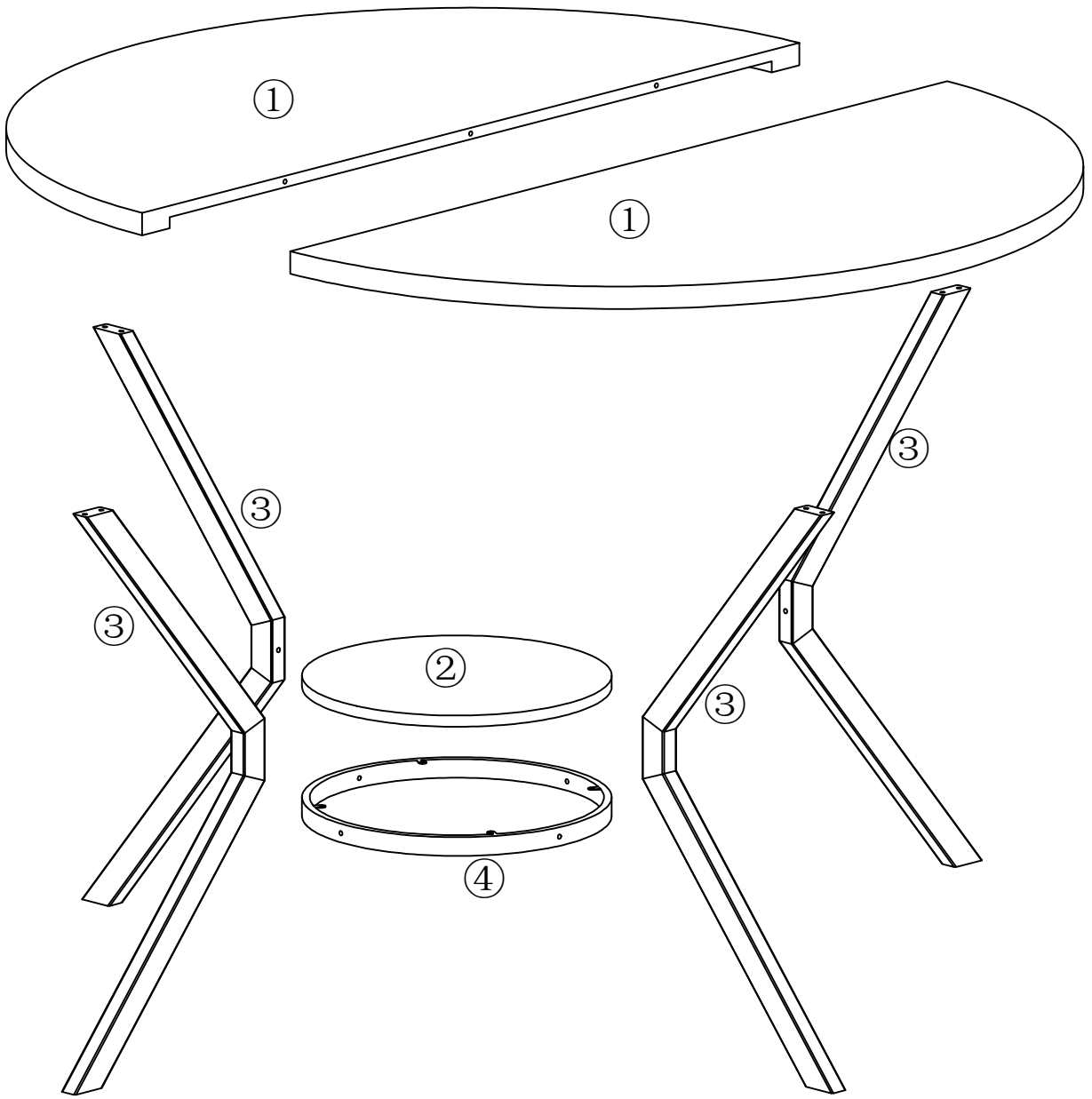

①

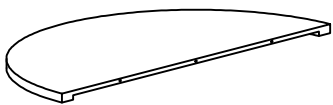

2PCS

②

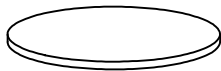

1PC

③





4PCS

④

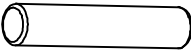

1PC

Hardware List

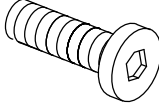
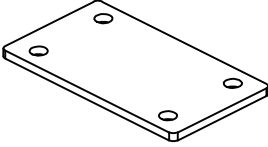
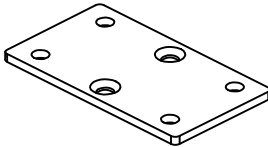
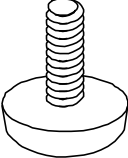
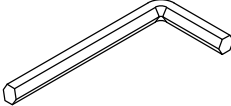
<p>A ×3</p>  <p>6*30mm</p>	<p>B ×28</p>  <p>M6*12mm</p>	<p>C ×8</p>  <p>M6*12mm</p>
<p>D ×4</p>  <p>M6*30mm</p>	<p>E ×2</p>  <p></p>	<p>F ×4</p>  <p></p>
<p>G ×4</p>  <p>M6*15mm</p>	<p>H ×1</p>  <p>M4</p>	



philips head screw driver
required of assembly
(Not include)

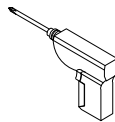

electric drill
(Not include)

STEP 1

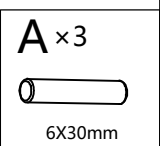
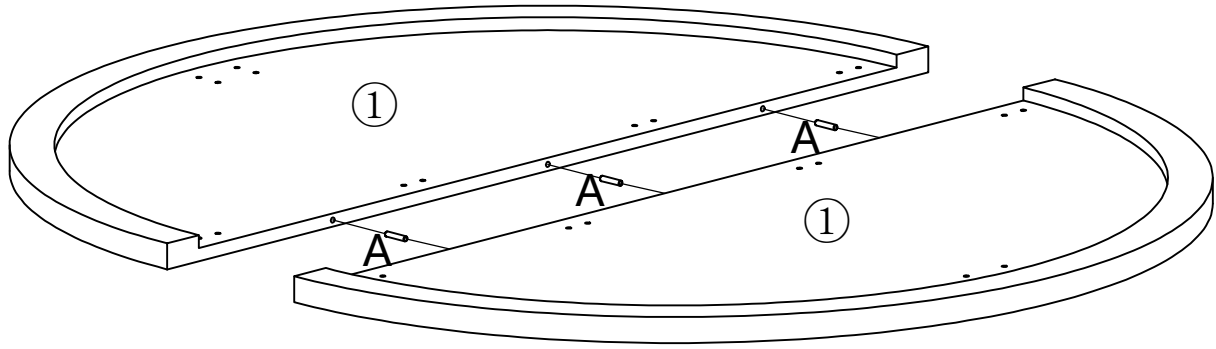

STEP 2

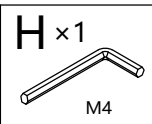
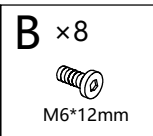
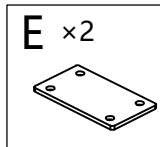
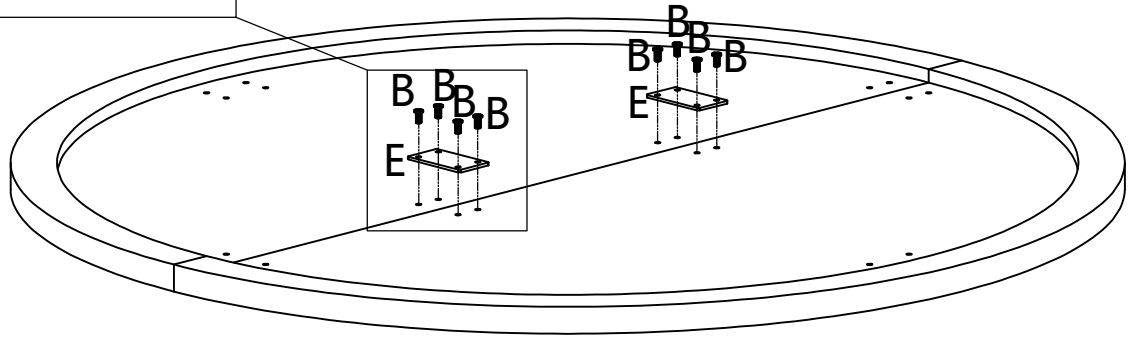
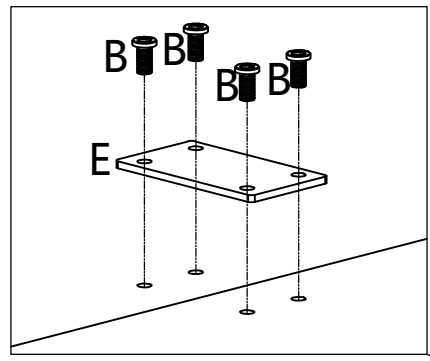
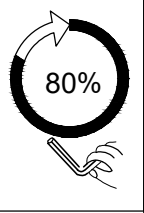

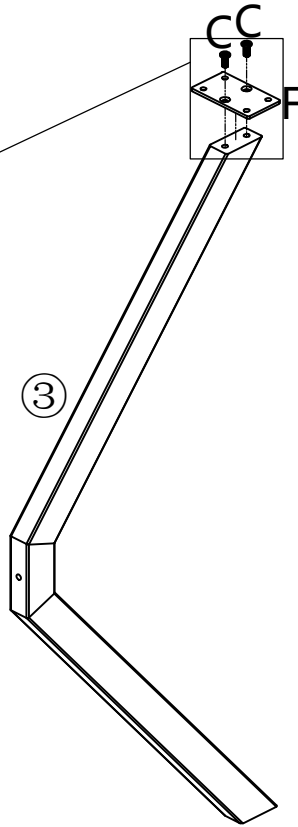
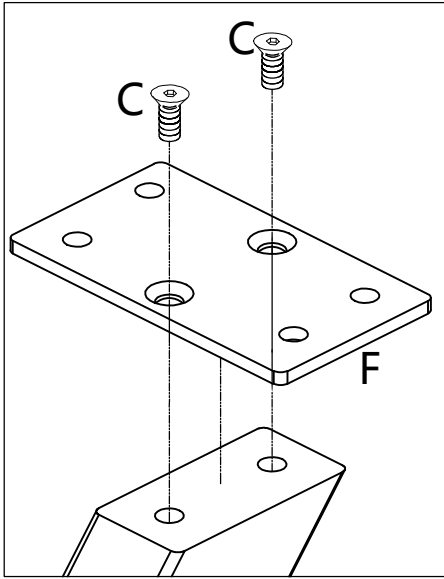

STEP 3



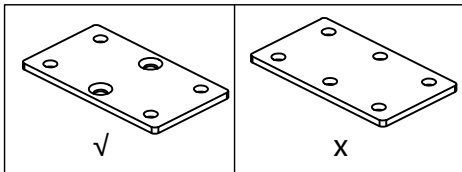

x4



F x4 	C x8 M6*12mm 	H x1 M4 
--	---	--

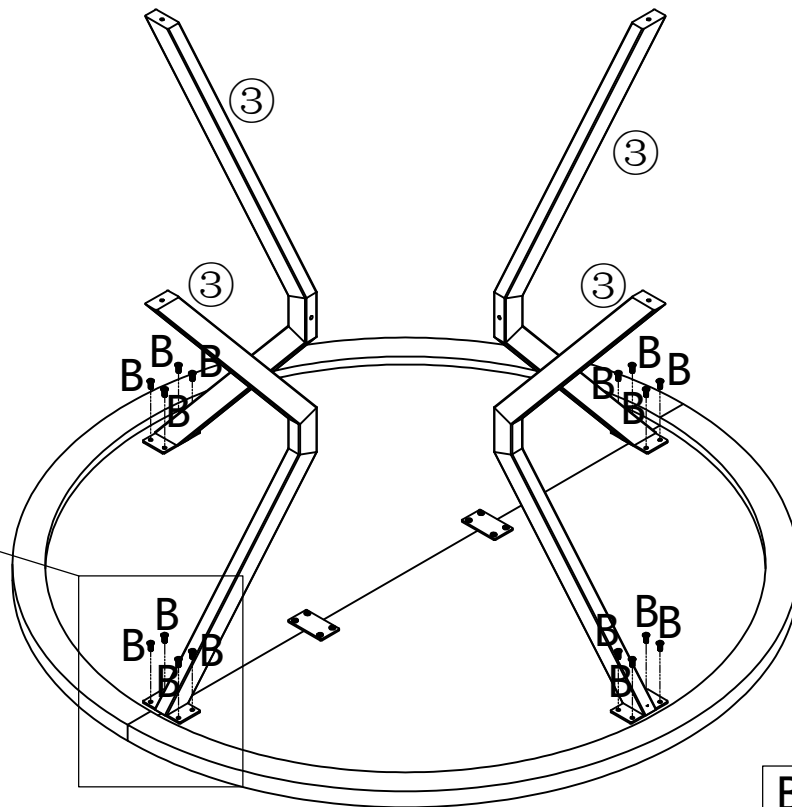
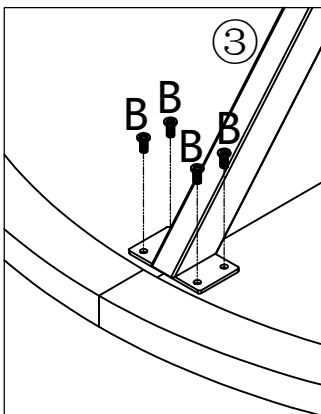
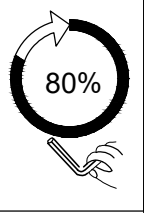

STEP 4



B x16 M6*12mm 	H x1 M4 
--	--

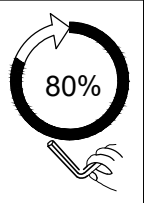
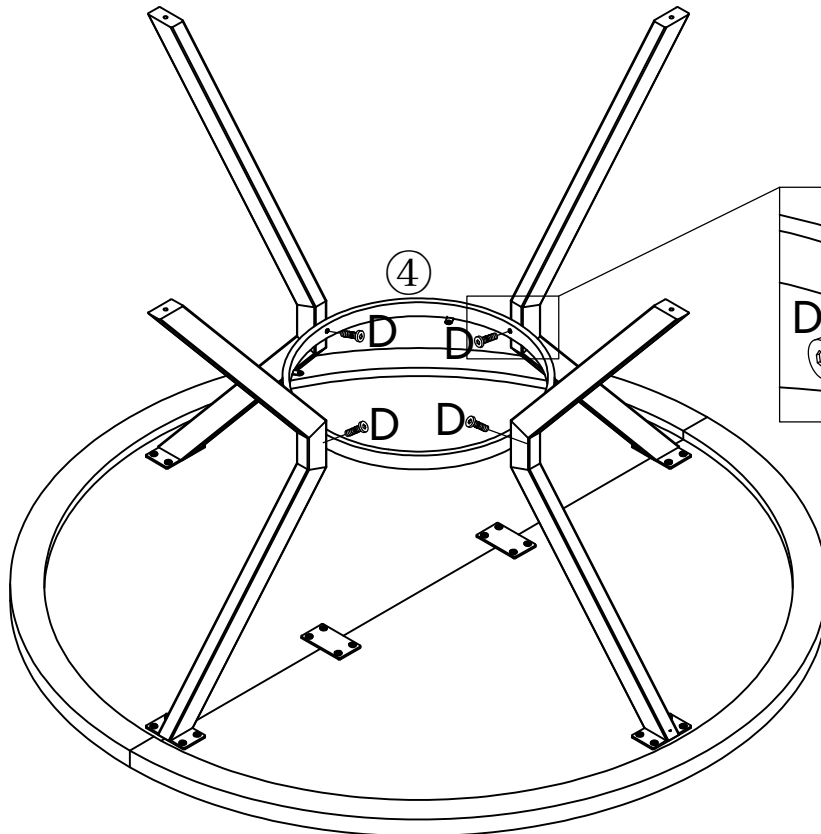

STEP 5

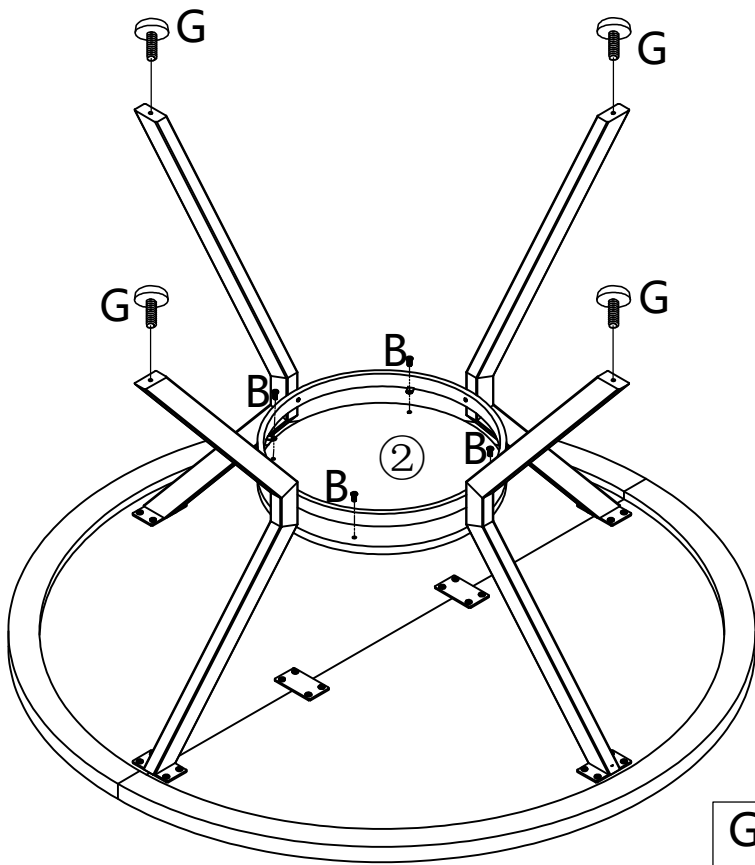

D × 4  M6*30mm	H × 1  M4
--	---

STEP 6



G × 4  M6*15mm	B × 4  M6*12mm	H × 1  M4
--	--	---