

# ASSEMBLY INSTRUCTIONS

## bed - Twin

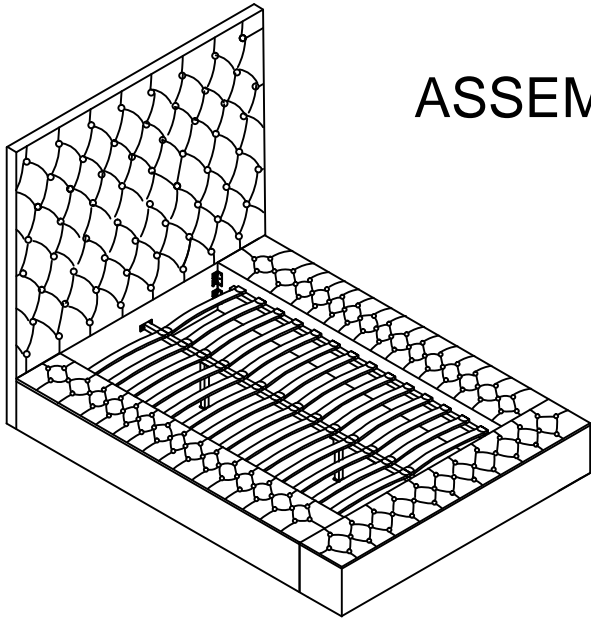

**+ Do Not Use Power Tools**

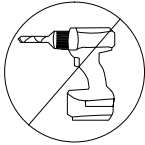

**+ Suggested Adults**

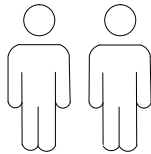

### NOTE:

- 1 Read instructions cover to cover.
- 2 Save all packaging until assembly is completed.

### 1 IMPORTANT SAFETY INFORMATION

Do not assemble the product if any of the following parts arrived damaged:

- Part #③ -Side Rails
- Part #⑤ -Center Support Bar
- Part #⑥ -Support Legs
- Part #⑦ -Slats

### 2 IMPORTANT ASSEMBLY INFORMATION

Assembly Step ③ Ensure the side rail bracket is fully hooked onto bolt A loosely threaded with both washers on the OUTSIDE of the bracket first, then proceed to fully tightening all 4 corners.

Assembly Step ⑥ When installing slats, ensure that the curve is facing upwards. (↗) (↘)  
\*Slats come packed in the bottom of headboard carton.

### + Parts Included

① Head Board (1pc)

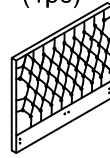

② Foot Board (1pc)

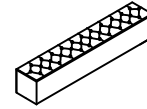

③ Side Rails (2pcs)

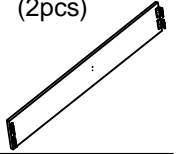

④ Side Rails (2pcs)

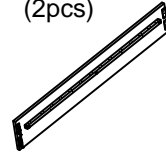

⑤ Center Support Bar (1pc)



⑥ Support Legs (2pcs)

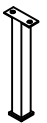

⑦ Slats (14pcs)

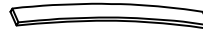

⑧ Single Plastic cap (28pcs)



\*Slats come packed in the bottom of headboard carton.

⑩ - Bracket (6pcs)



⑪ - Middle support board (1pc)



⑫ - Middle support board (2pcs)



\*Middle support Board comes packed in the footboard carton 2/3

\*Middle support Board comes packed in the footboard carton 2/3

⑬ - Side bottom board (2pcs)



\* 1 of 2 side bottom boards comes packed in side rail carton 3/3. 2/2 packed in footboard carton 2/3

⑭ - Side top board (2pcs)



### + Hardware Included

A Bolt M8\*30mm (36pcs)



B Bolt M8\*20mm 26pcs



C Nut M8\*13mm (4pcs)



D Spring Washer (32pcs)



E Flat Washer φ20 (66pcs)



F M8 Allen Key (1pc)



G Spanner (1pc)



H Bolt M8\*25mm (4pcs)



# ASSEMBLY INSTRUCTIONS

## bed - Twin

