

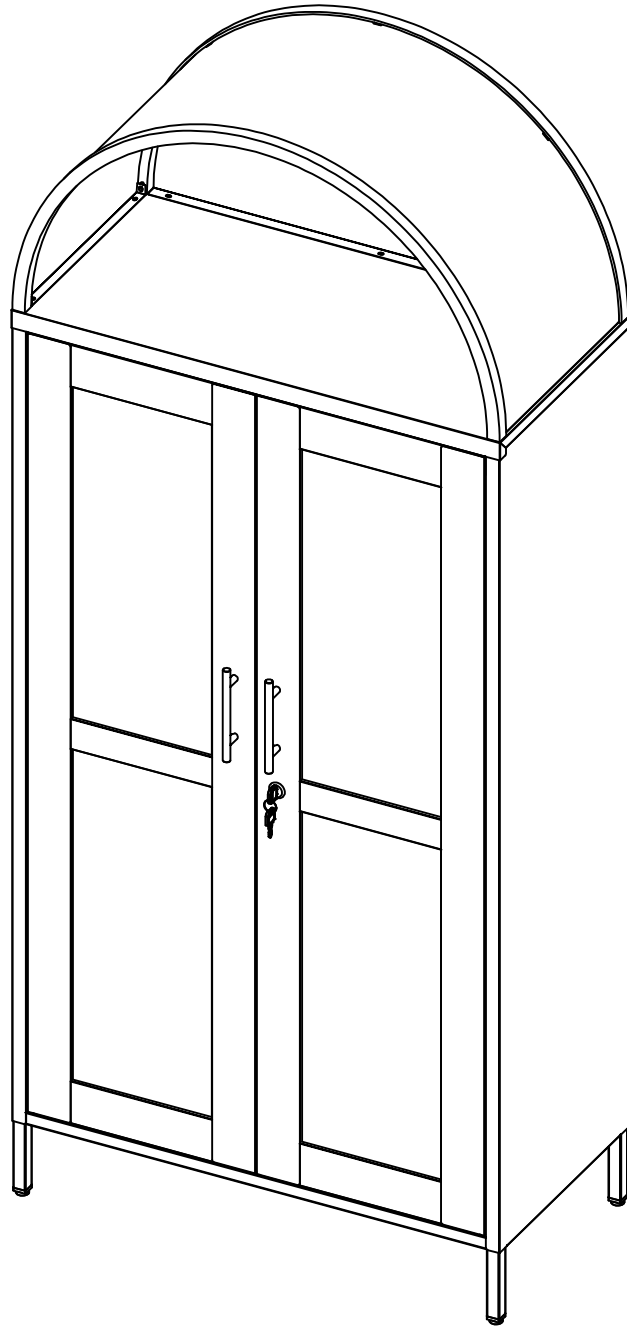

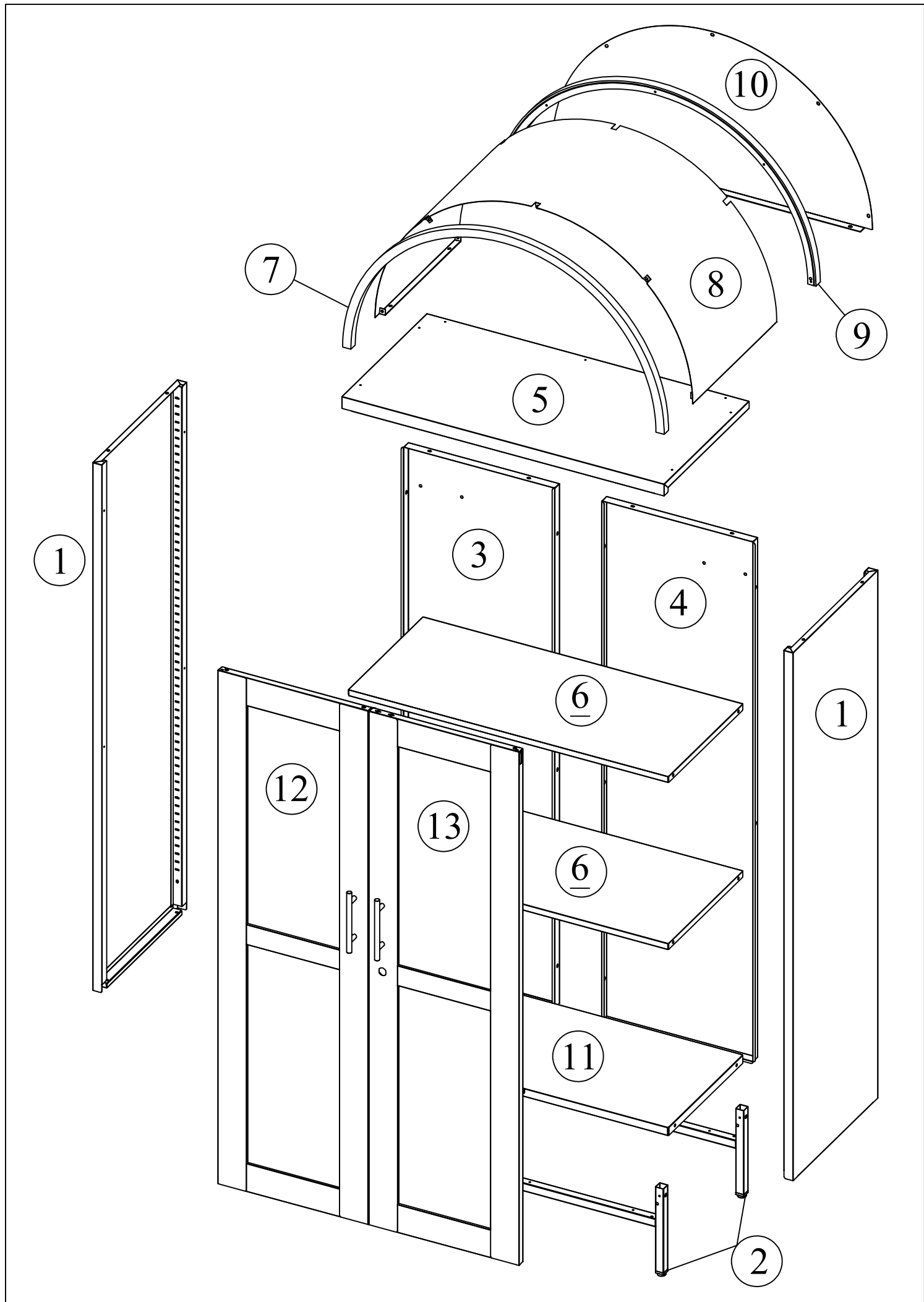

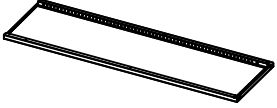





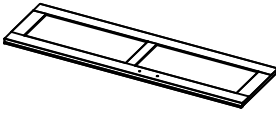

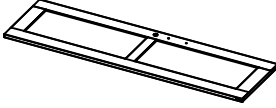
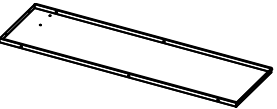

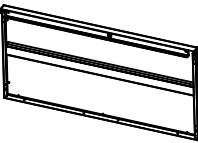
# Assembly Instructions

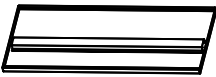



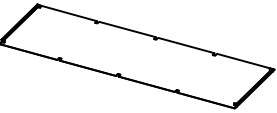
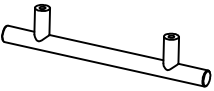
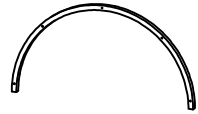
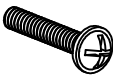

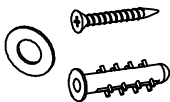



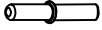

# Accessories

Name		Picture	Qty	Name		Picture	Qty
1	Side panel		2	11	Floor		1
2	Kick plate		2	12	Left door		1
3	Left back panel		1	13	Right door		1
4	Right back panel		1	A	13/32 Screw		42
5	Top panel		1	B	M5 Nut		3
6	Shelf		2	C	M5*10 Screw		3
7	Dome front tube		1	D	Shelf clasp		8
8	Dome panel		1	E	The doorknob		2
9	Dome back tube		1	F	M4*22 screw		4
10	Dome back panel		1	I	Expansion screw		2

# Accessories

Name		Picture	Qty	Name		Picture	Qty
K	Door pivot		2	M	Shock absorber		4
L	Shim		4	Q	Light		3
Lock rod cap				(Already attached on right door 13)			
Key				(Already attached on right door 13)			
Lock				(Already pre-installed on right door 13)			
Lock rod				(Already pre-installed on right door 13)			



## CAUTION

---

An assistant is required.

**CUSTOMER FIRST, SERVICE FOREMOST!**  
 Questions? Issues?  
**CONTACT US**  
 REPLY WITHIN 24 HOURS IN BUSINESS DAYS

# Step 1

Insert side panels 1 into kick plates 2 and fix them with screws A

Ⓐ  × 4

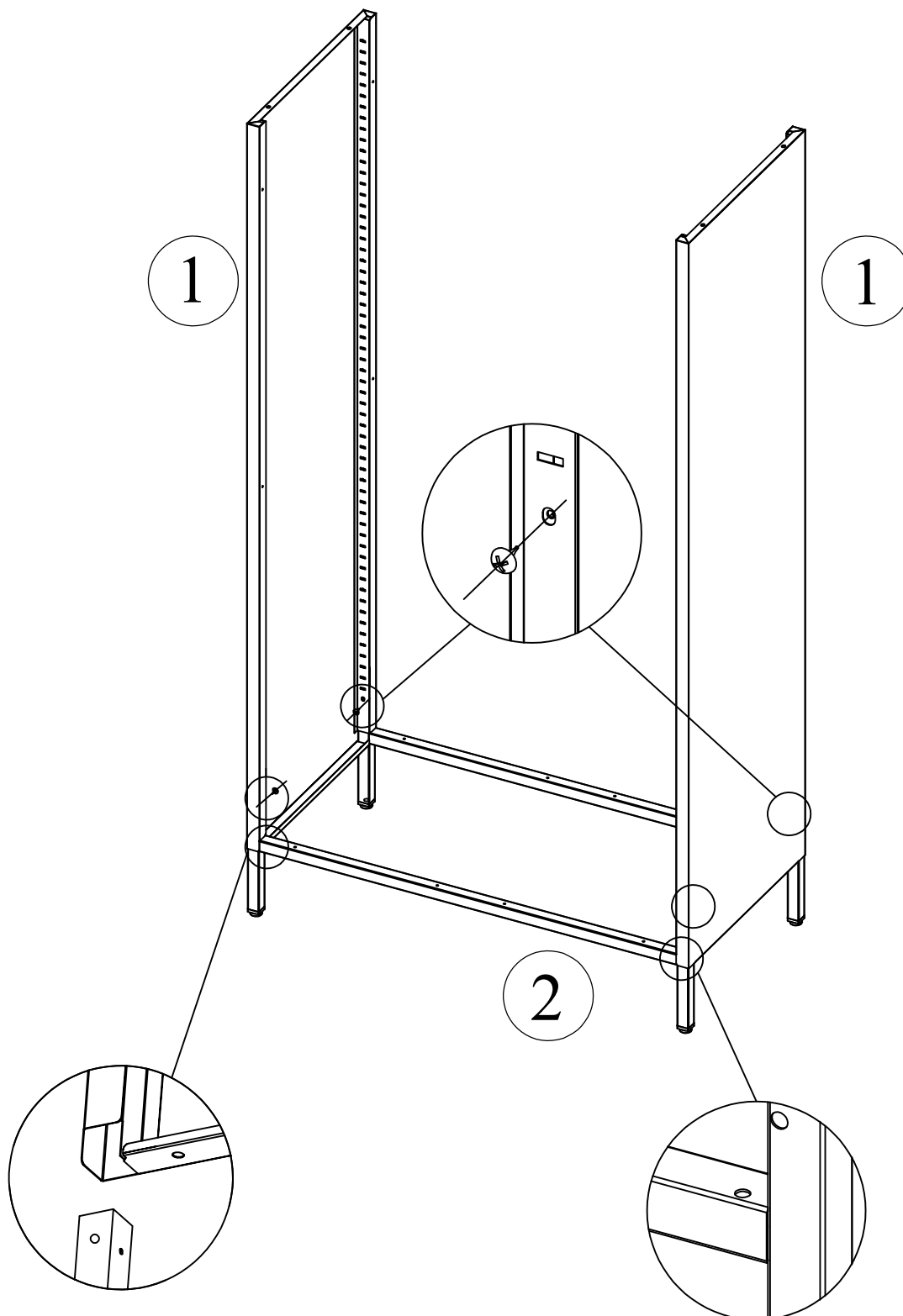

The door shaft hole is in the front

# Step 2

Connect left back panel 3 with side panel 1 and kick plate 2 by screws A

Ⓐ  × 4

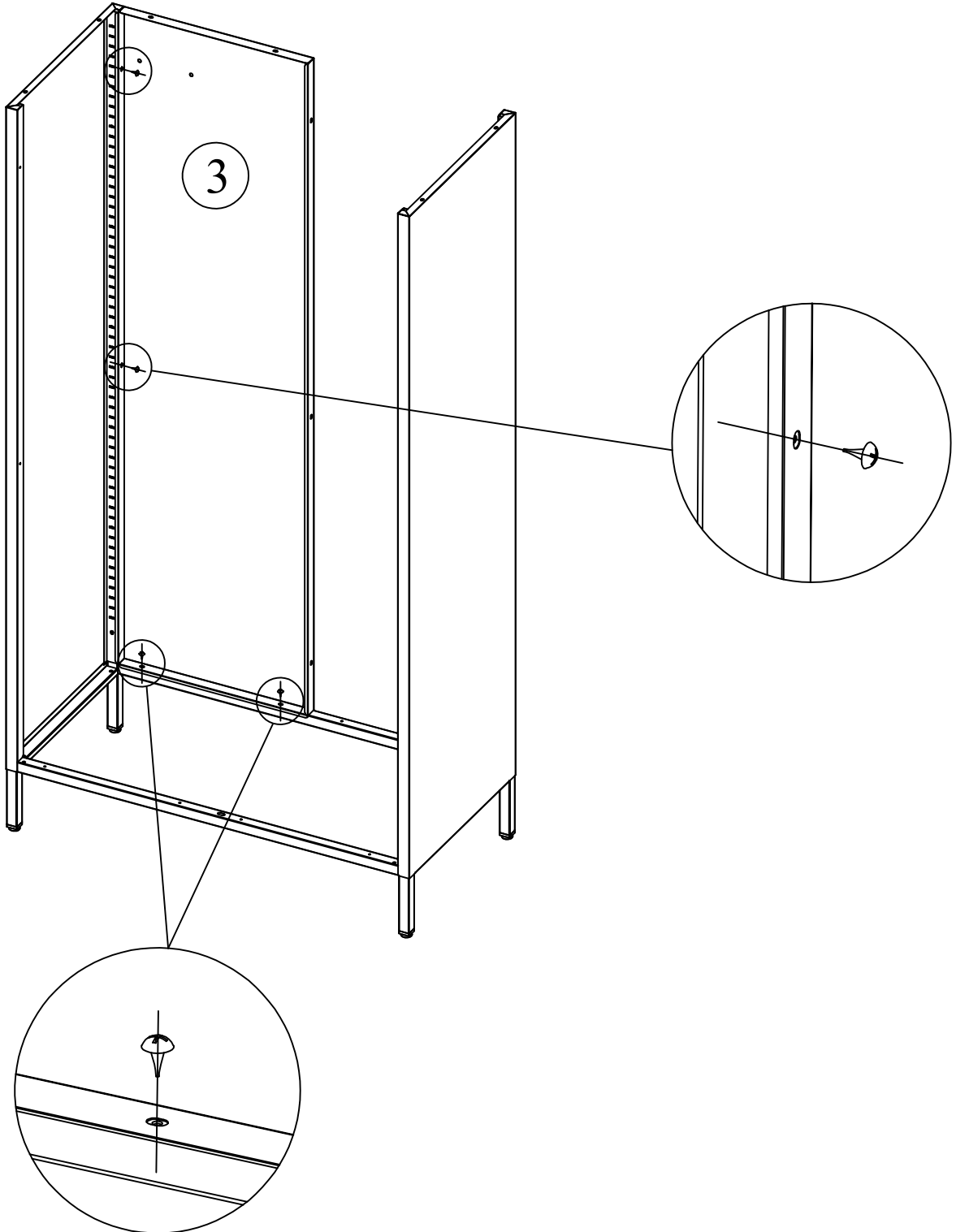

# Step 3

Connect right back panel 4 with side panel 1 and kick plate 2 by screws A, then connect two back panels 3 and 4 with nuts B and screws C

(A)  × 4

(B)  × 3

(C)  × 3

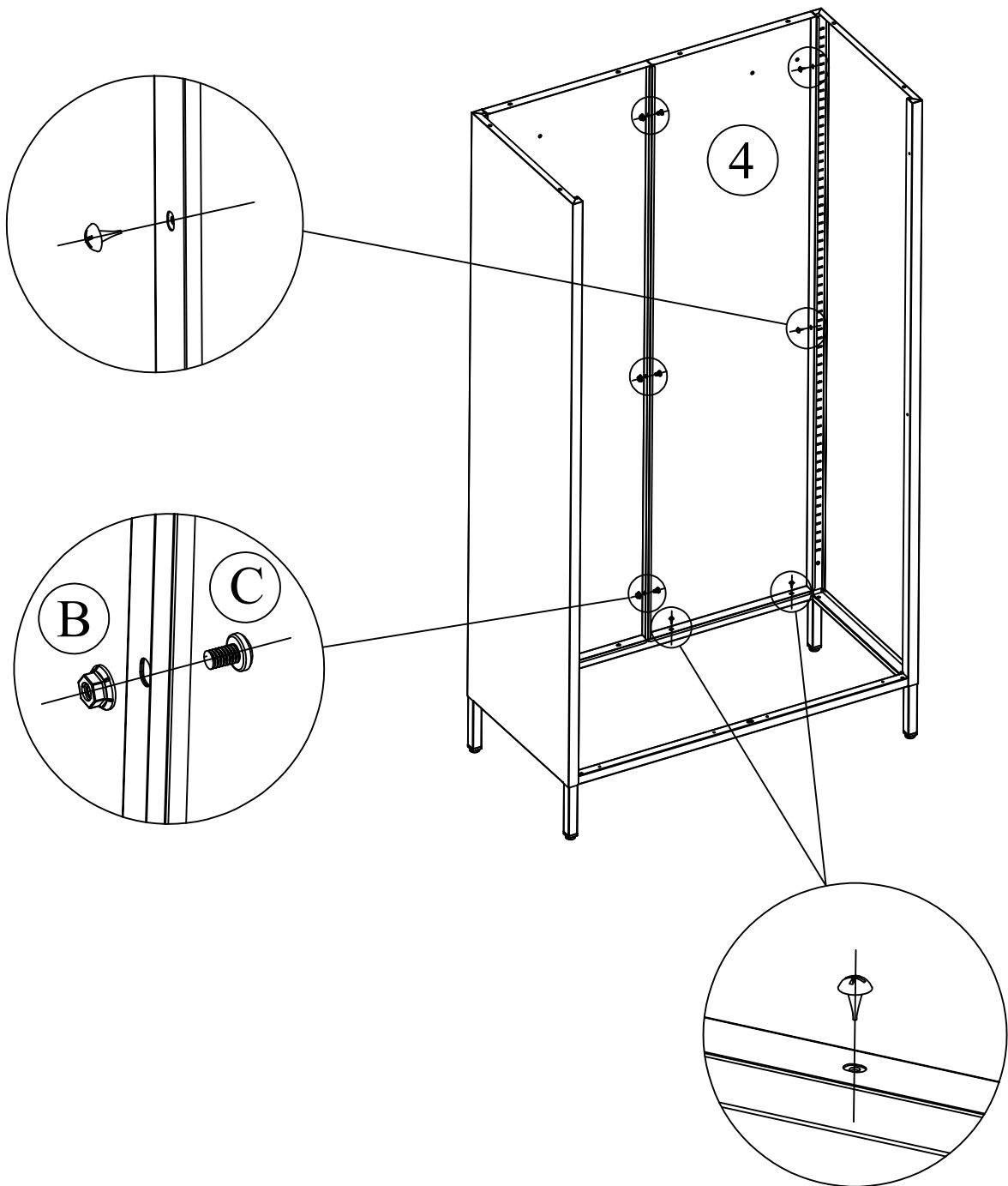

# Step 4

Connect top panel 5 with back panels and side panels by screws A

Ⓐ  × 8

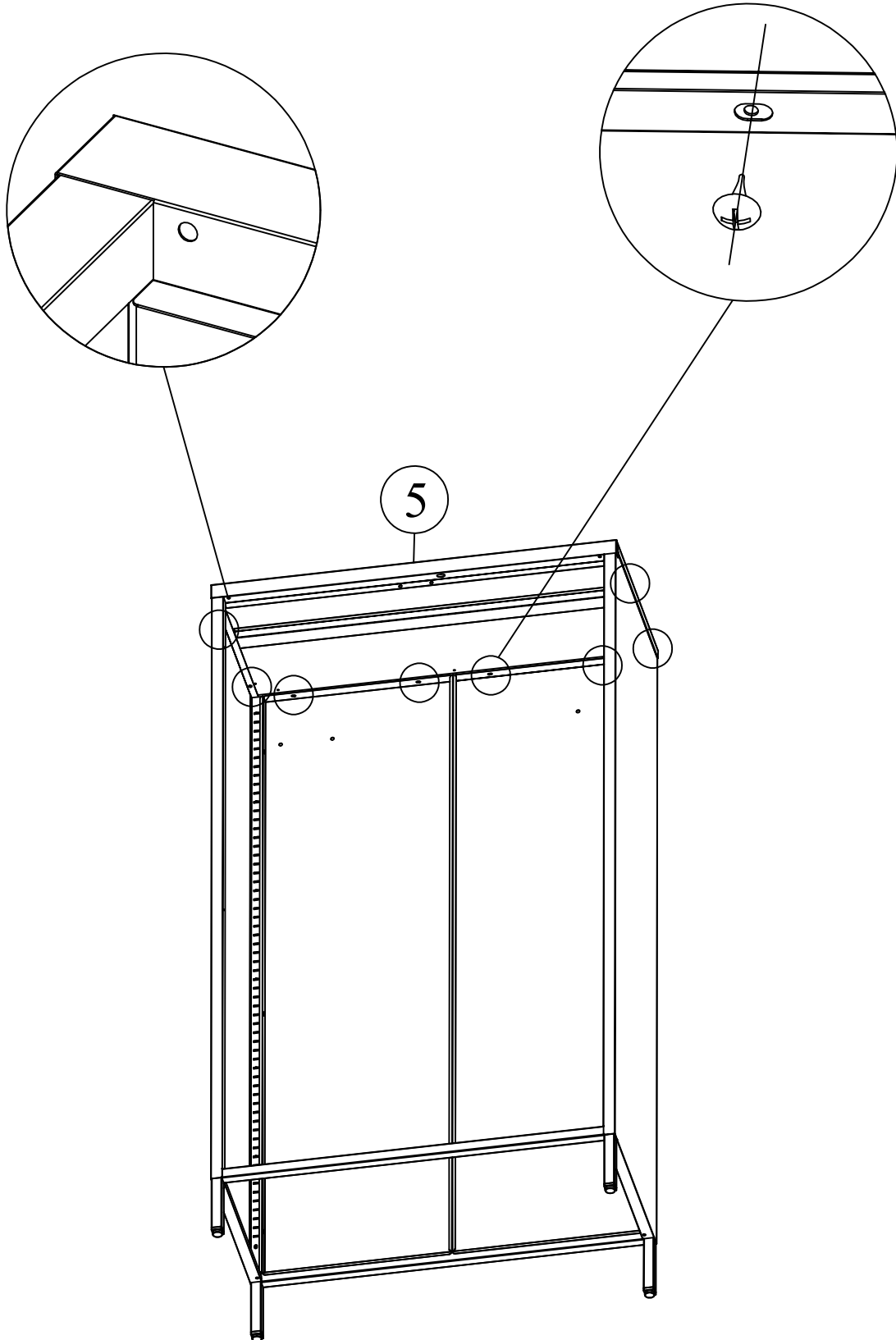

# Step 5

Install the shelf clasps D and put the shelves 6 on them

Tilt floor 11 into the cabinet and press it down to snugly fit against the kick plate (No screws are needed to fix the floor)

Install 4 shock absorbers M on the top and bottom as shown below

(D)  × 8



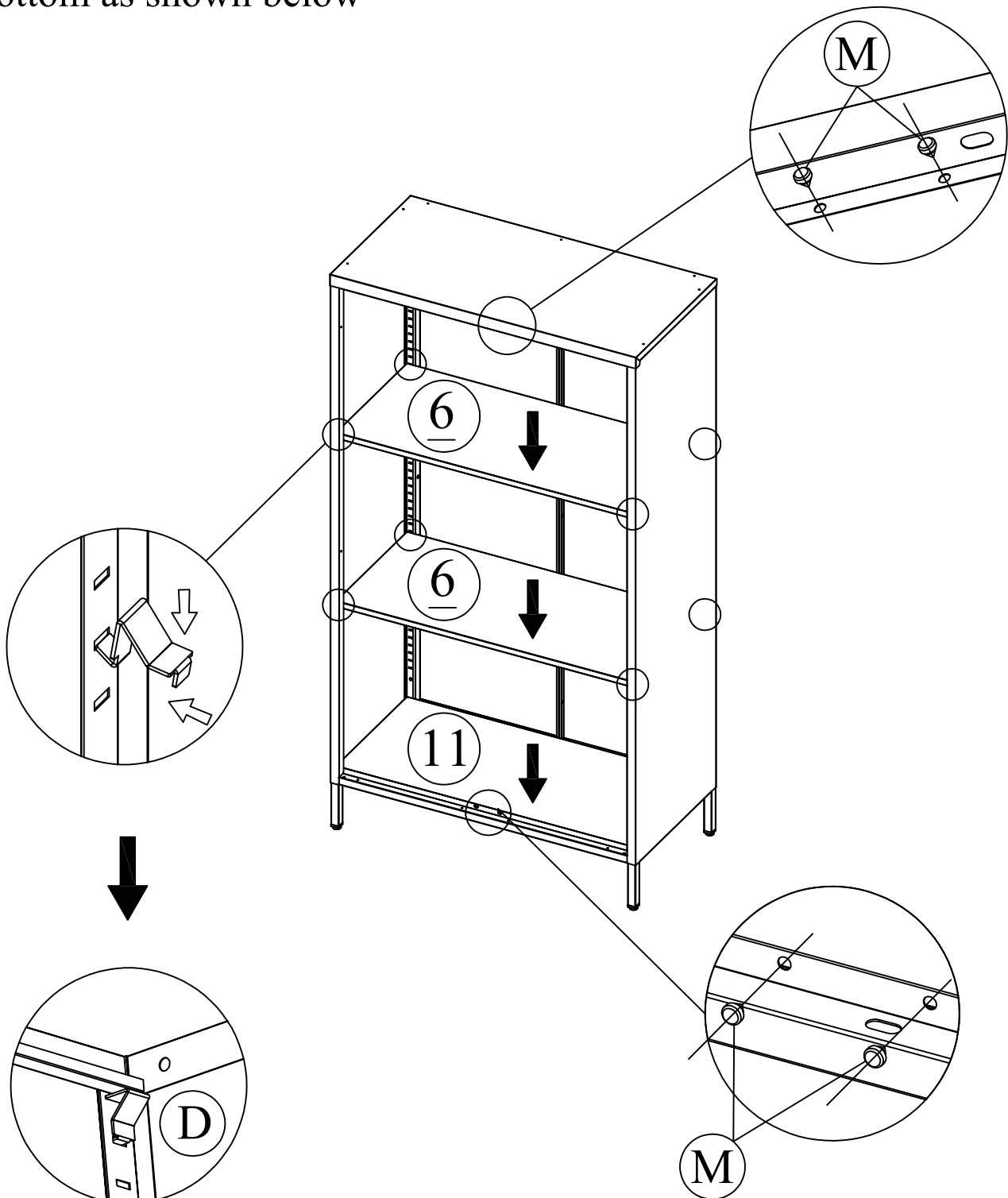

(M)  × 4



# Step 6

Insert the door pivots K into the holes of the both sides of the bottom corners (shims L can be used to adjust), then insert the doors into the door pivots on the bottom and adjust the spring shaft on the top

Install 2 doorknobs E on the doors with screws F

- |     |   |     |
|-----|---|-----|
| (K) |  | × 2 |
| (L) |  | × 4 |
| (F) |  | × 4 |
| (E) |  | × 2 |

Spring shaft

Please remove the keys from the right door 13 and store them safely before proceeding with this step.

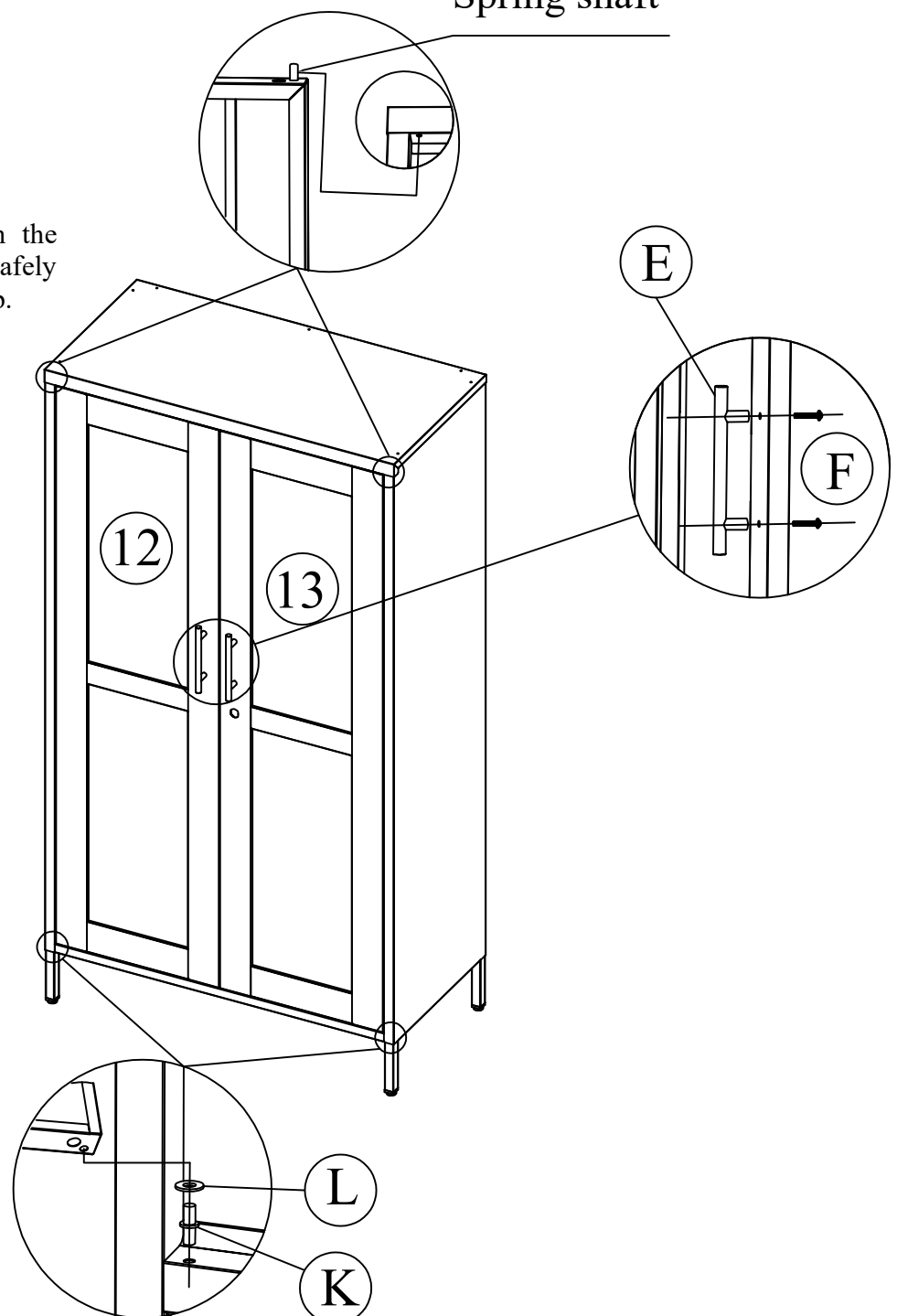

There are two holes here, and K should be inserted into the smaller hole.

# Step 7

Fold all the small parts on dome panel 8 towards the middle for 90 degree

Insert dome panel 8 into dome back tube 9 and dome front tube 7

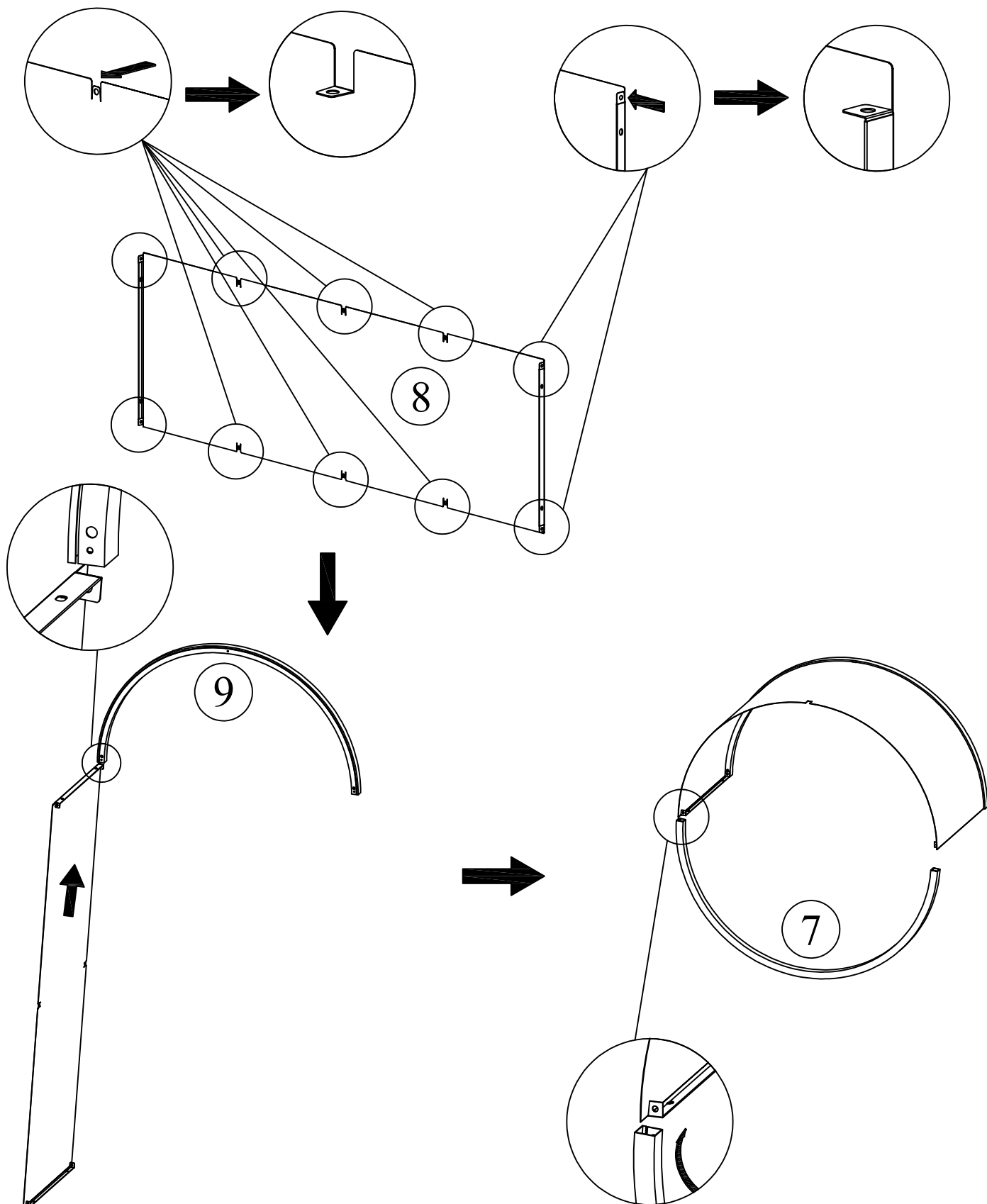

# Step 8

Fix the dome panels and tubes with 10 screws  
A in the middle and ends

(A)  × 15

Fix the dome back panel 10 with 5 screws A

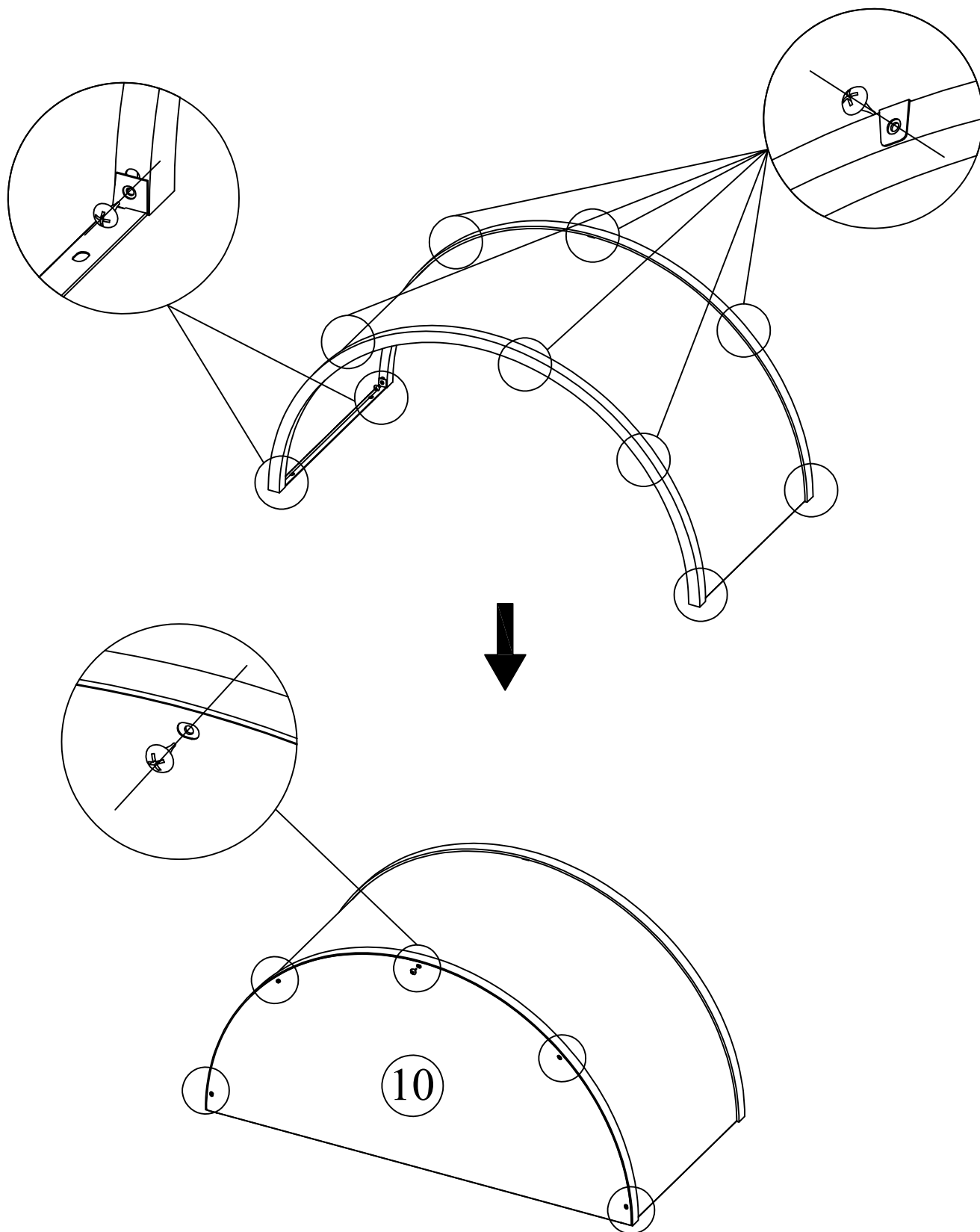

# Step 9

Fix the dome on the top of the cabinet with screws A, then adjust the feet of the cabinet

(A)  × 7

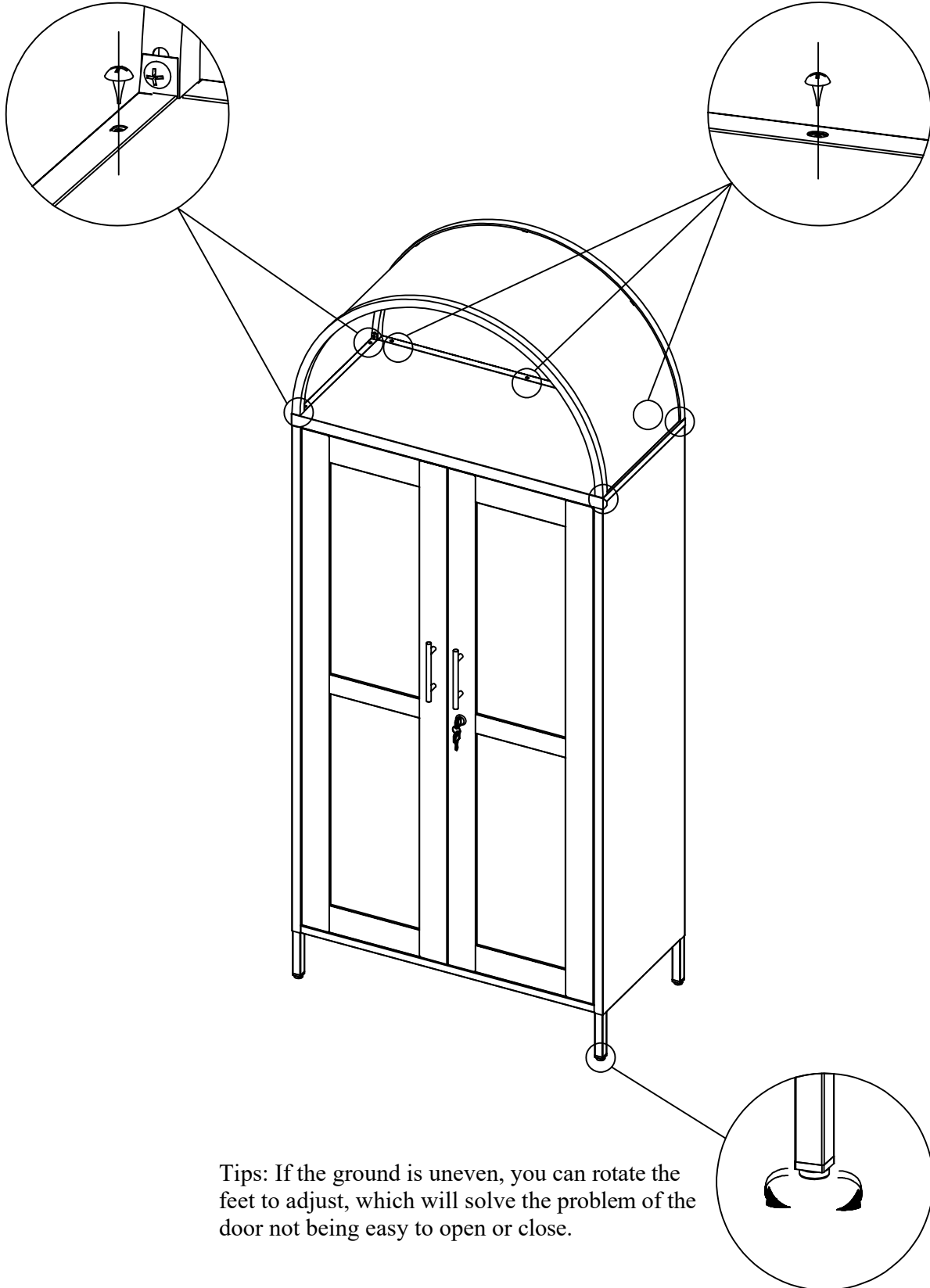

Tips: If the ground is uneven, you can rotate the feet to adjust, which will solve the problem of the door not being easy to open or close.

# Step 10

Fix the cabinet to the wall with screws  
I to prevent tipping

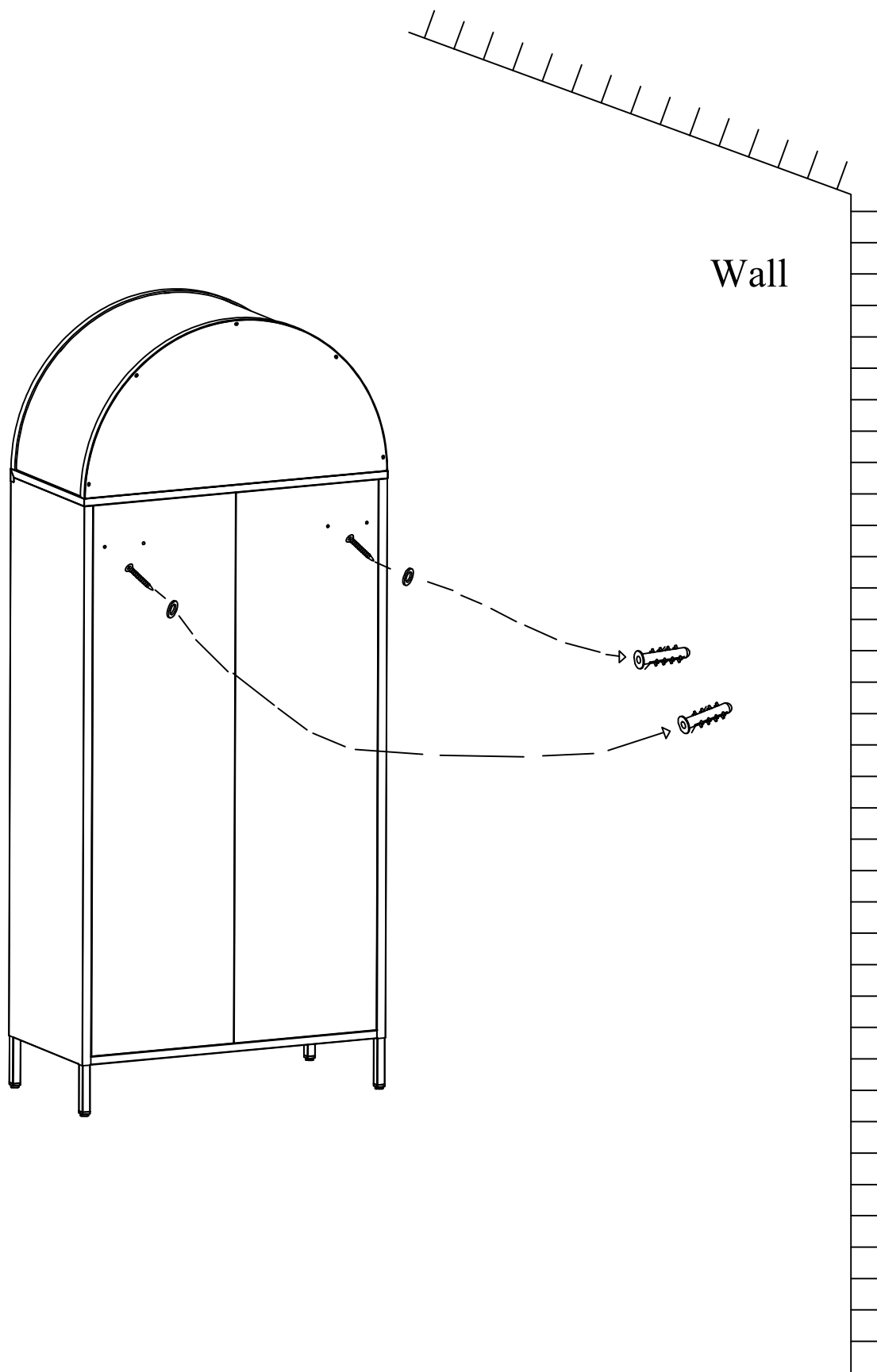
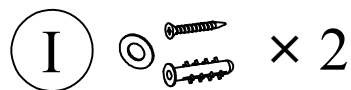

# Step 11

Attach the lights Q on the top panel 5 and shelves 6

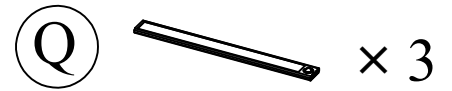

(The lights are magnetic and perceptible. The position of lights can be adjusted freely. And it's recommended to place them near the exterior to avoid obstruction of their sensing range by the lower shelf. )



The detailed instructions of the lights are on the next page.

# MANUAL

Please read the manual before use.



(Caution) Please fully charge the battery before using it for the first time.

## Product list

■ Light \* 1

■ USB Charger Cable \* 1

## Function description

Button type	Function description
	<ul style="list-style-type: none"><li>■ Press button: Cycle switching white light, warm light, neutral light Note: monochrome models do not have this function!</li><li>■ Holding button: When the light is on, the brightness can be adjust by holding the button, and release to lock the brightness. (The brightness can be memorized)</li></ul>
	<ul style="list-style-type: none"><li>■ Initially closed.</li><li>■ Press the button for the first time to enter the ON mode. (In the ON mode, the sensing function won't work and the light stays on)</li><li>■ Press the button for the second time to enter the Night sensing mode. (The night sensing mode will be entered after the light flashes three times)</li><li>■ Press the button for the third time to enter the All day sensing mode. (The all day sensing mode will be entered after the light flashes two times)</li><li>■ Press the button for the fourth time to back to off.</li></ul>

### (Special instructions for sensing mode)

1. Setting the night sensing mode, the light will only turn on when both sensing human and in low light environment, otherwise it won't turn on.
2. Setting the all day sensing mode, the light will turn on when sensing human no matter there is enough light or not.
3. The light will automatically turn off when human left the sensing range for after 25 seconds.
4. The light stays on if human keeps in the sensing range.

## Notes for sensing mode

1. The installation position such as too low, too high or the probe was blocked will affect the sensing range, it is recommended to be mounted facing the side passing by to ensure the better effect.
2. The sensing mode can be blocked by glass.

## Sensing range description

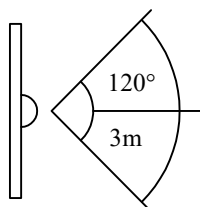

- The sensing range of the lamp is the area within 120° and 3 meters with the probe as the center point.  
However, improper installation or blocking the sensing probe will affect the sensing sensitivity.

# MANUAL

## Charging description

■ Charging voltage: DC5V      ■ Red light -- charging      Green light -- fully charged

Charging precautions:

1. Do not use a charging device with output voltage greater than 5v to charge the light!
2. In order to ensure charging safety and efficiency, please use the mobile phone charging adapter with safety certification to charge the light!
3. Do not use when charging. (The sensing mode can't work normally which effected by the charging light when charging)

## Cautions

1. Please fully charge the battery before using it for the first time, otherwise the light may not be used because of the circuit protection. (The protection is automatically released after charging)
2. Do not use the light under high temperature and humidity. This product is not suitable for outdoor.
3. The light source and battery of the product are irreplaceable. After a long time of use, when the brightness of the product is very low under full power state or the power usage duration becomes shorter under normal usage, the whole lamp shall be replaced.

## FAQs

Q: Just received the light, why can't turn it on?

A: Please fully charge the battery before using it for the first time, otherwise the light may not be turn on because of the circuit protection. (The protection is automatically released after charging)

---

Q: Why won't it turn on when sensing human? / Why it turns on at daytime? / How long will it turn off after sensing human?

A: As shown in page one (Special instructions for sensing mode)

---

Q: The sensor is not sensitive enough / only worked when you walk closer? How wide is the sensing range?

A: The sensing range of the lamp is the area within 120° and 3 meters with the probe as the center point. However, improper installation or blocking of the sensing probe will affect the sensing effect.

As shown in page one ( Notes for sensing mode )

---

Please contact the seller if the manual can not solve your problem,thank you for your choice and trust.