

ASSEMBLY INSTRUCTIONS

HYCK-011

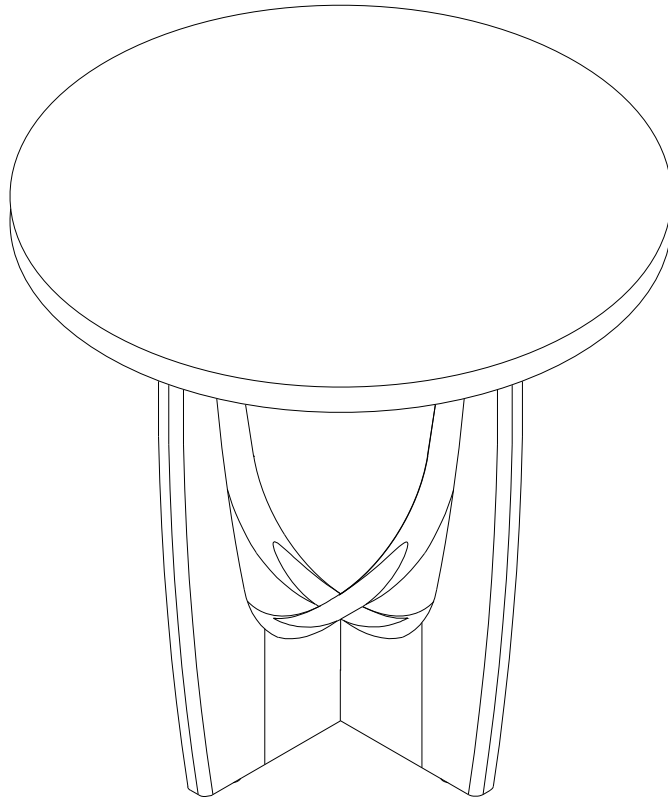

Notice:

1. Follow the installation instructions. Please confirm all accessories are preset before installation.
2. Do not fully tighten the screws during initial assembly. Fully tighten screws only once all pieces which are correctly assembled.
3. If you encounter any problems during installation, please contact our customer service.
4. Please unbox the item from the side with an open-label and put a carpet on the floor to avoid scratching it.

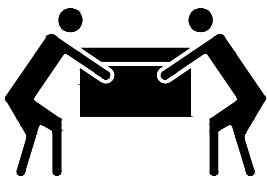

Recommended installers:2

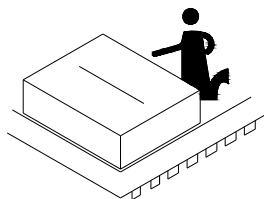

Put a carpet on the floor
before unpacking

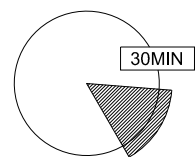



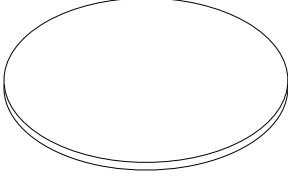
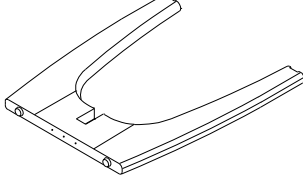
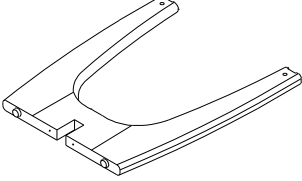

Estimate installation time:
30minutes

ASSEMBLY INSTRUCTIONS

PART LIST

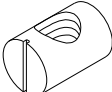
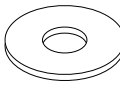
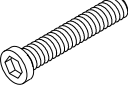
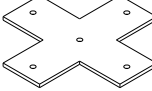
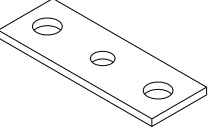
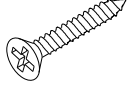
Item no.	Reference Image	Qty	Item no.	Reference Image	Qty
Ⓐ		X1	Ⓒ		X1
Ⓑ		X1			

HARDWARE LIST

Item no.	Reference Image	Qty	Item no.	Reference Image	Qty
①		X4	⑥		X8
②	 M6X40mm	X4	⑦		X1
③		X4	⑧	 Ø4X22mm	X5
④	 Ø1/4"X3/4"	X8	⑨		X1
⑤		X8			

ASSEMBLY INSTRUCTIONS

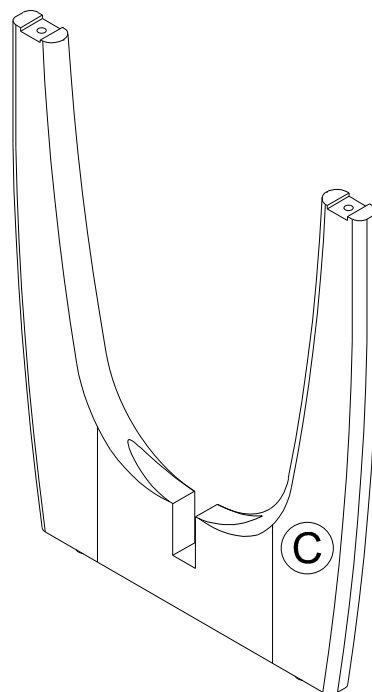
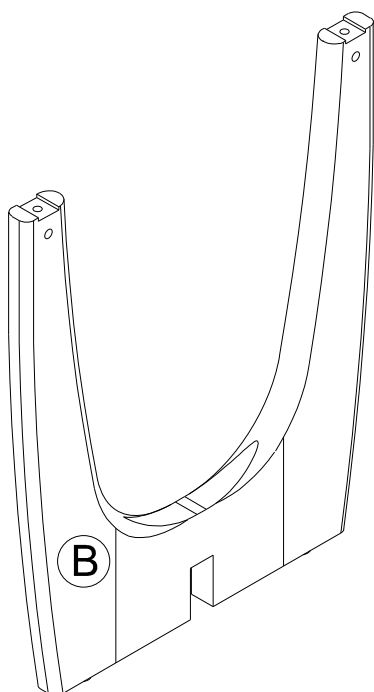
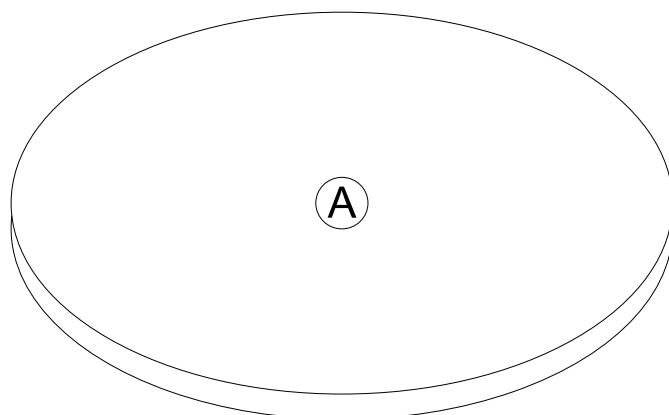

ASSEMBLY INSTRUCTIONS

1

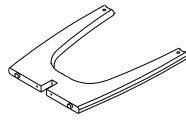

(B) 1pc

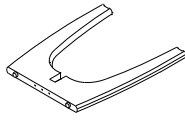

(C) 1pc

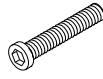

(2) 4pcs

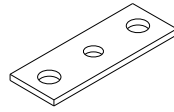

(3) 4pcs



(1) 4pcs

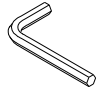

(7) 1pcs

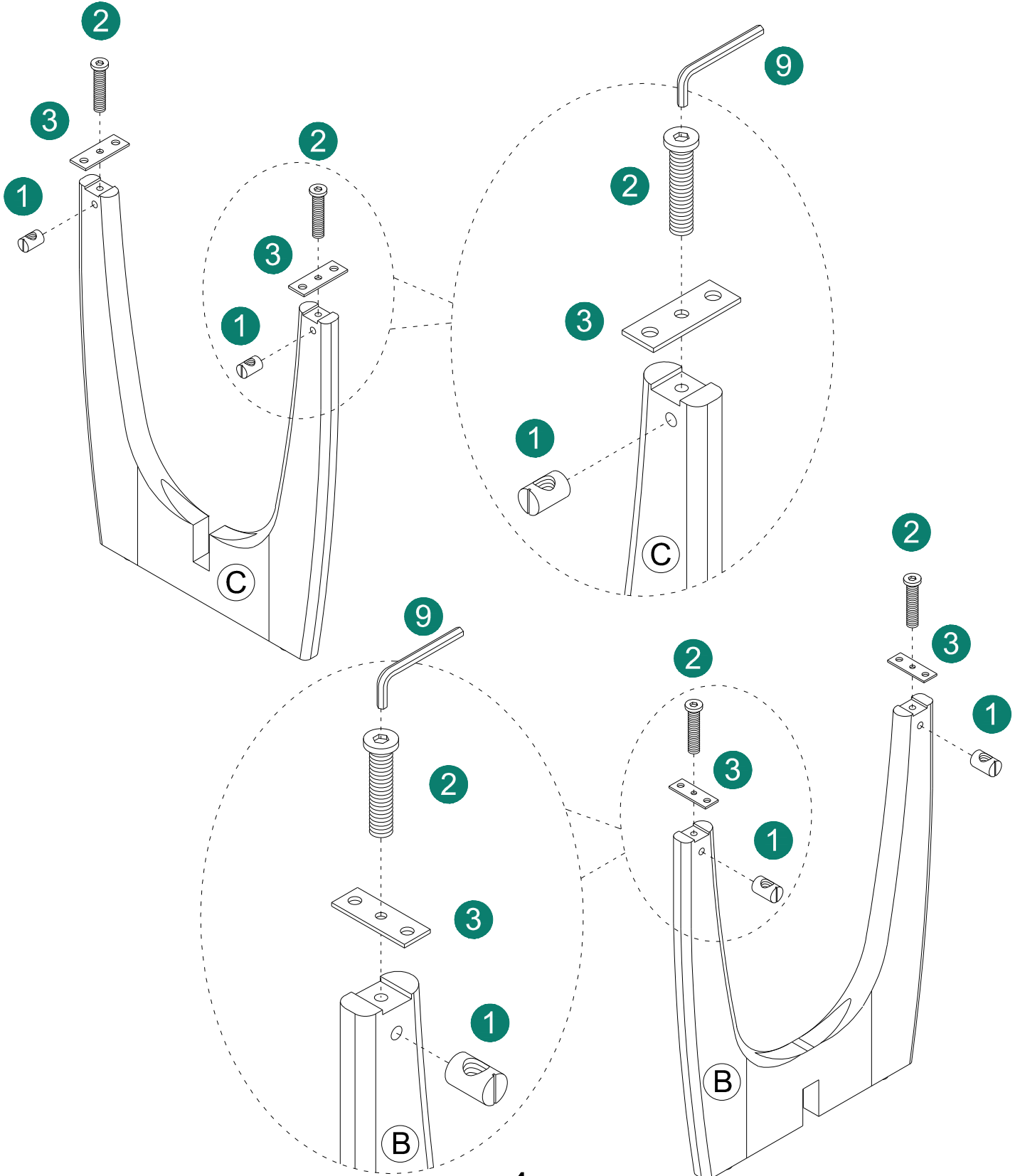

4

ASSEMBLY INSTRUCTIONS

2

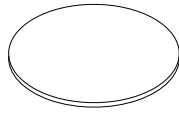

A 1pc



4 4pcs



5 4pcs

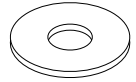

6 4pcs

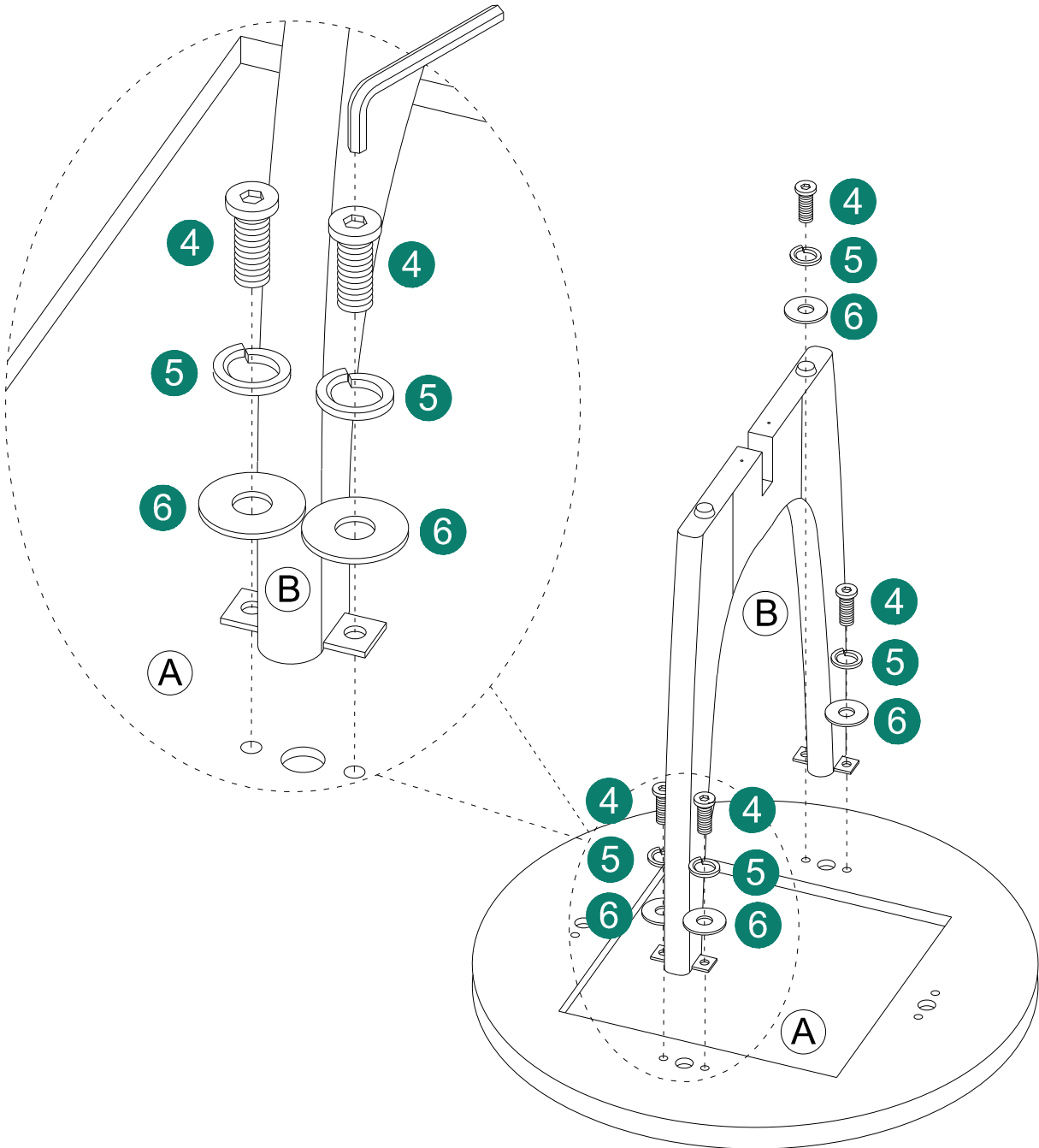

ASSEMBLY INSTRUCTIONS

3



4 4pcs



5 4pcs

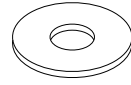

6 4pcs

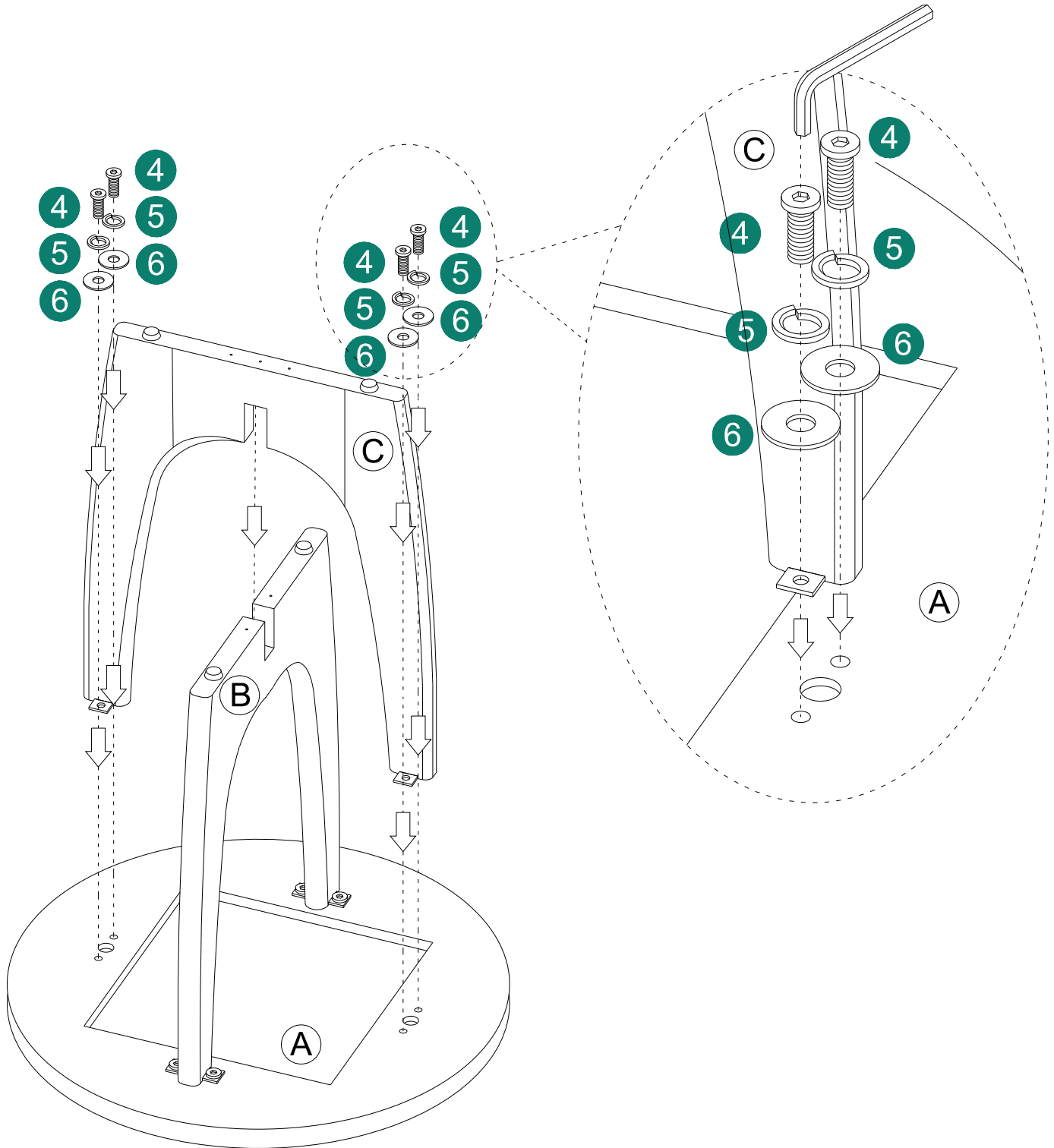

ASSEMBLY INSTRUCTIONS

4

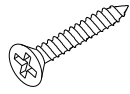

8 5pcs

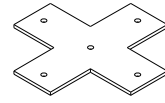

7 1pcs

