

# **Carport Canopy 10 x 20 ft**

## **Assembly Instruction**





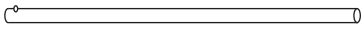
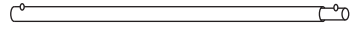
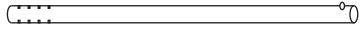
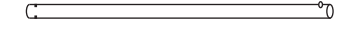
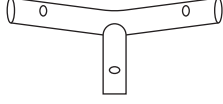

# SAFETY INSTRUCTIONS

1. The instant garage needs to be installed on a smooth surface.
2. It is recommended to wear gloves during assembly.
3. You may need to use a ladder during assembly. Please pay attention to safety.
4. If any part of the product is damaged, please do not use it.
5. Do not stand or sit on the top of the instant garage.
6. Do not smoke or use open flame devices in and around the instant garage to avoid fire.
7. Ensure that you anchor your garage with heavy material – sandbags work best – the heavier the better. If you are experiencing strong winds above level 7, we recommend you do not use the device and put it away for storage until the winds have passed.
8. It is not recommended to use it in snowy conditions.
9. Assemble in strict accordance with the instructions, and use ropes, anchor, and other accessories in the assembly process.

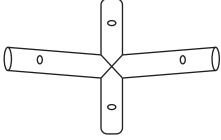
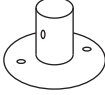
## Parts List and Diagram

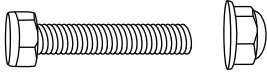
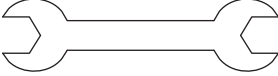
Item No.	Reference Image	Qty.	Item No.	Reference Image	Qty.
<b>1</b>		x8	<b>2</b>		x9
<b>3</b>		x17	<b>4</b>		x4
<b>5</b>		x4	<b>6</b>		x6

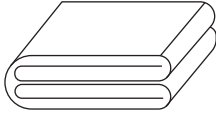
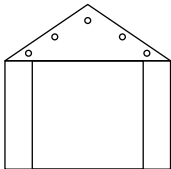
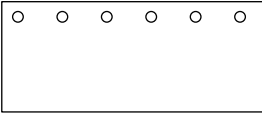
# Parts List and Diagram

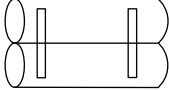
Item No.	Reference Image	Qty.	Item No.	Reference Image	Qty.
7		x6	8		x8
9		x8	10		x80
11		x8	12		x1
13		x4	14		x1
15		x2	16		x2
17		x4	18	 Sandbags	x4

# Assembly Steps

## STEP 1

Place the jacking pipe fittings.

Connect and install the top pipe fittings (#1& #2& #3) with the connectors (#6& #7).

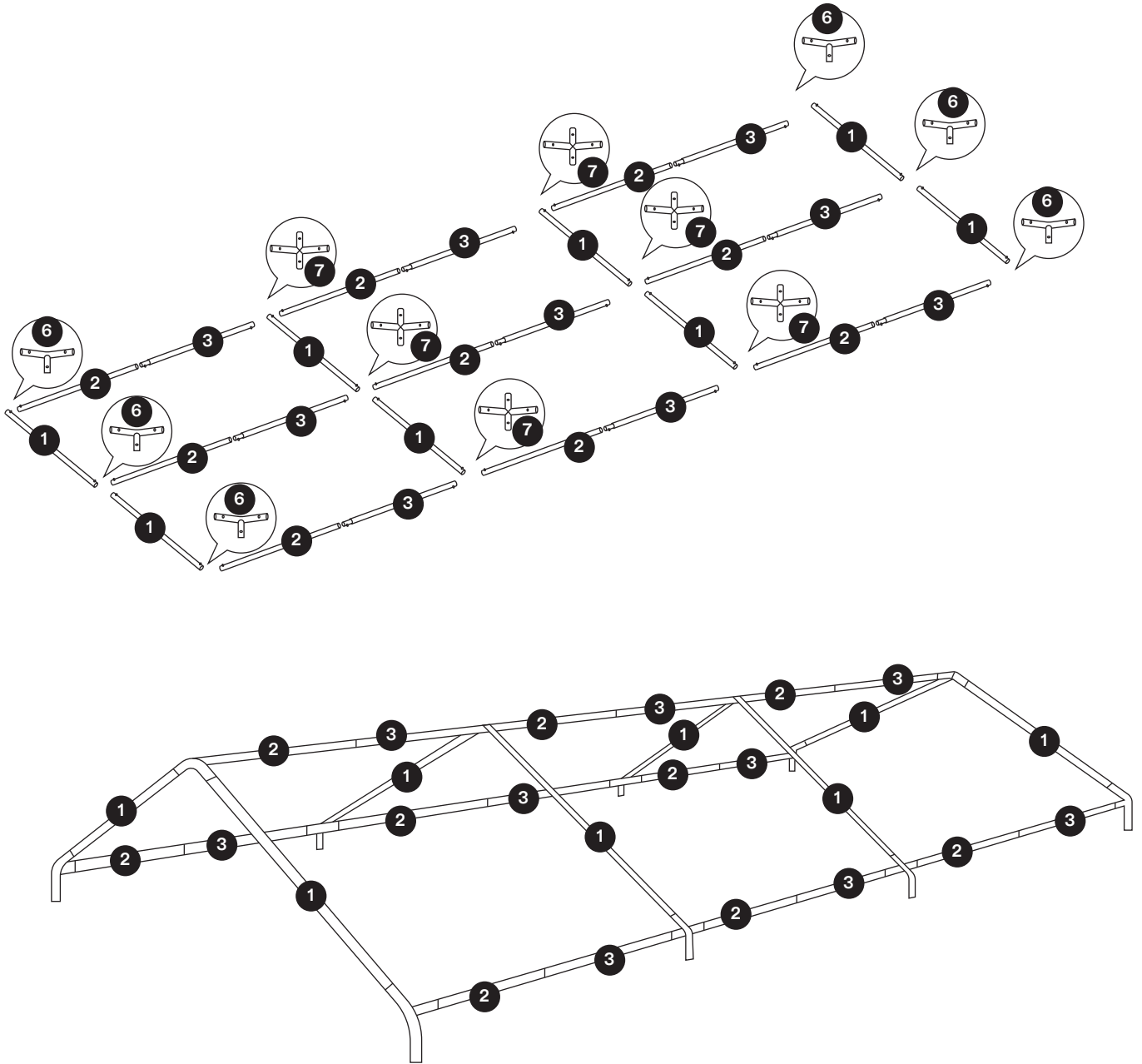

# Assembly Steps

## STEP 2

Assemble the leg tubes (#3& #4& #5) on one side first.

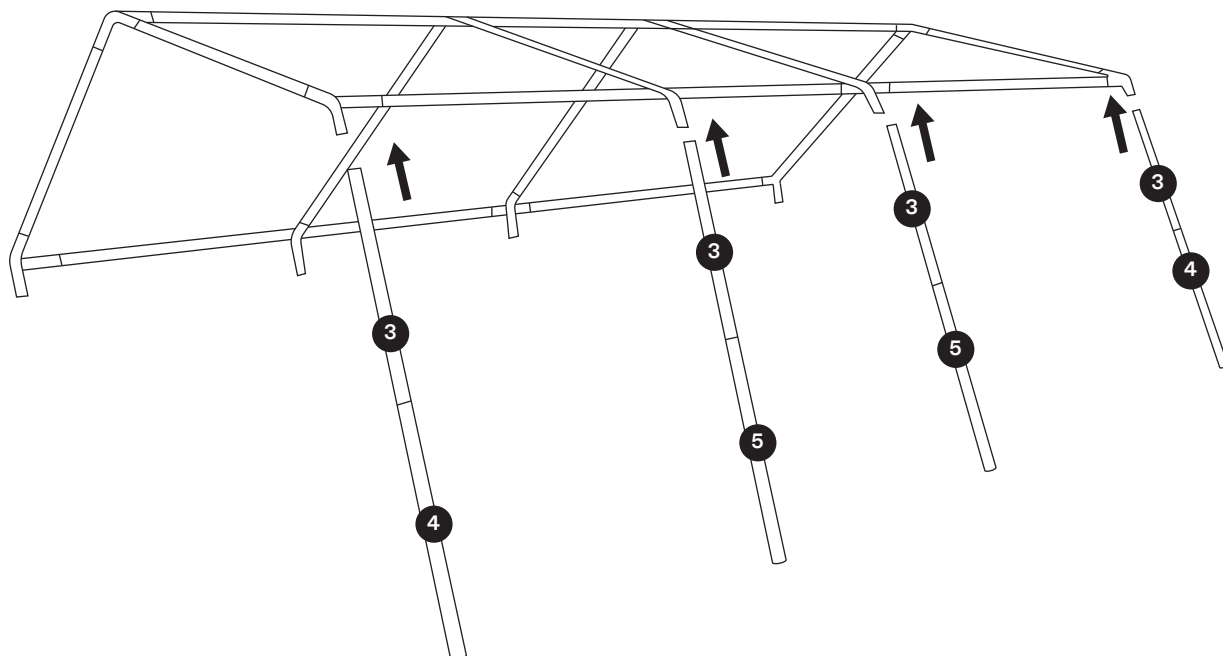

## STEP 3

Place the canopy (#14) over the trellis assembled and secure it with the elastic bands with balls (#10).

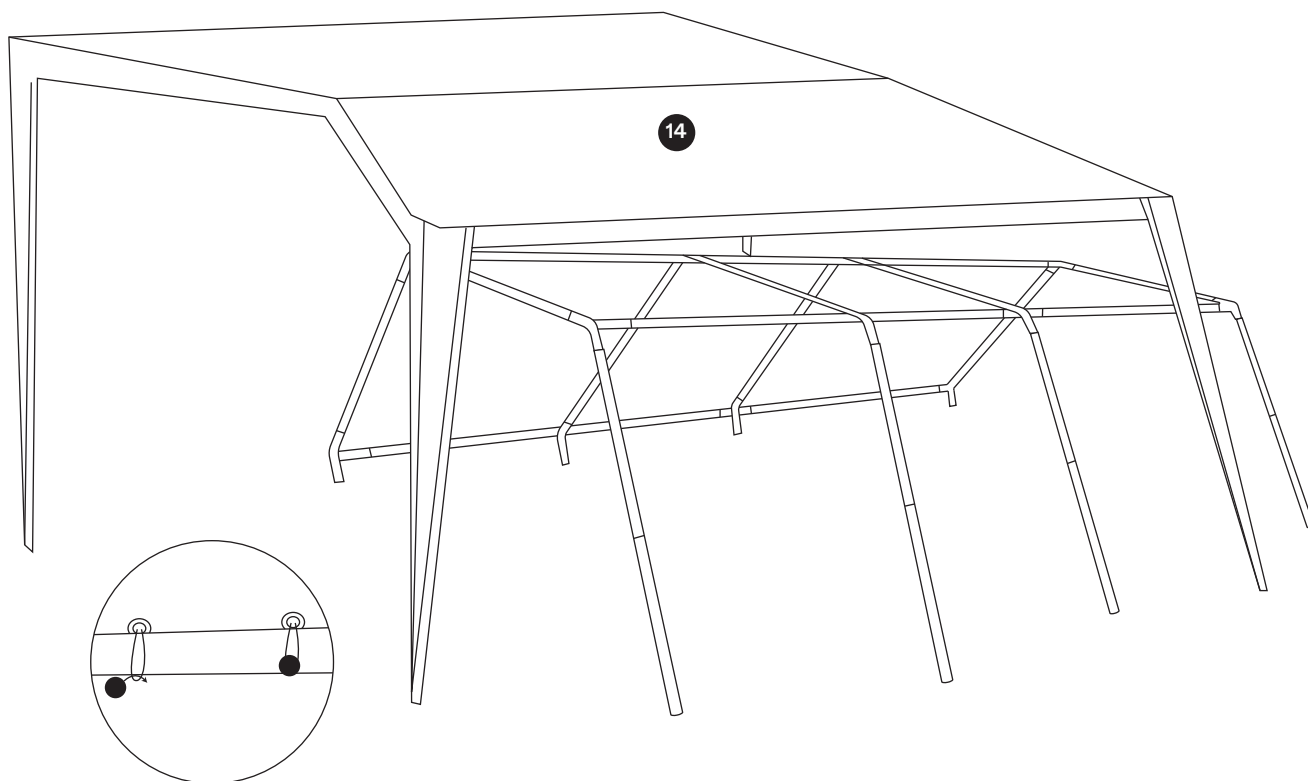

# Assembly Steps

## STEP 4

Assemble the leg tubes (#3& #4& #5) on the other side.

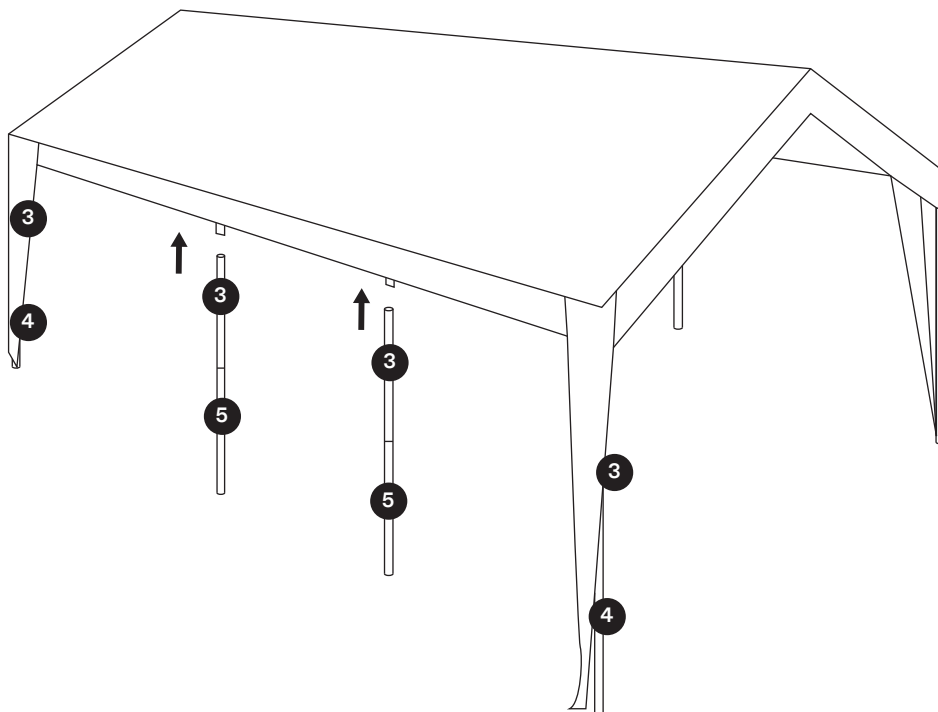

## STEP 5

Use the elastic bands with balls to tie the side clothes (#16) to the trellis.

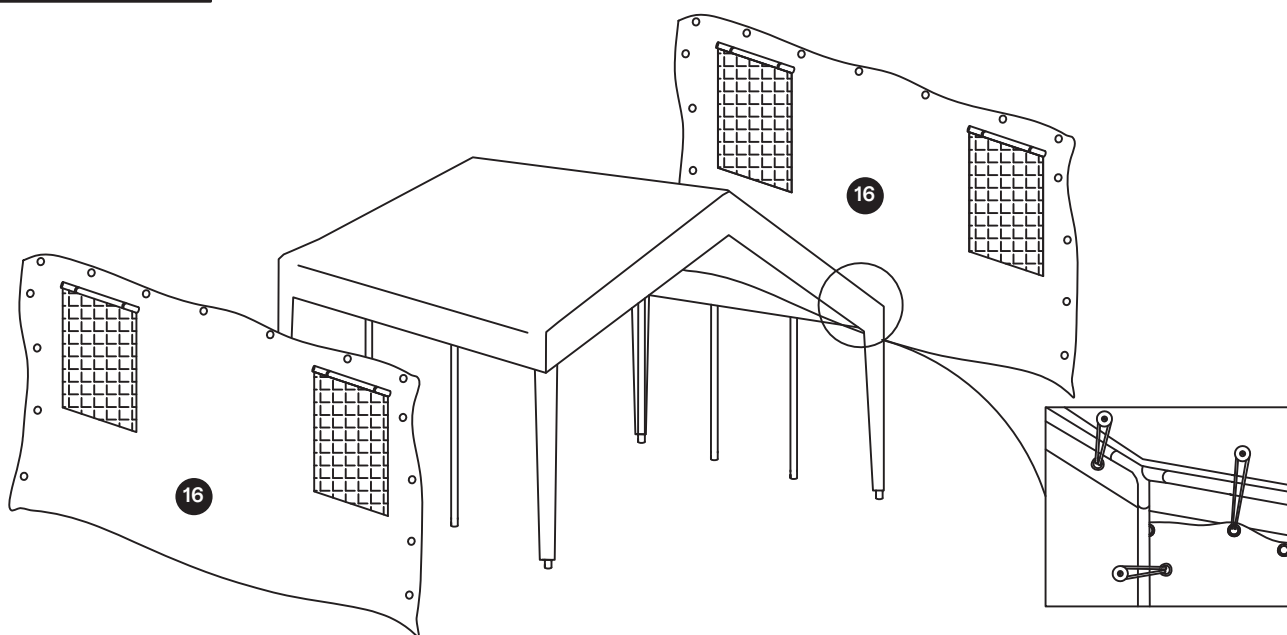

# Assembly Steps

## STEP 6

Use the elastic bands with balls to tie the front and rear doors (#15) to the trellis.

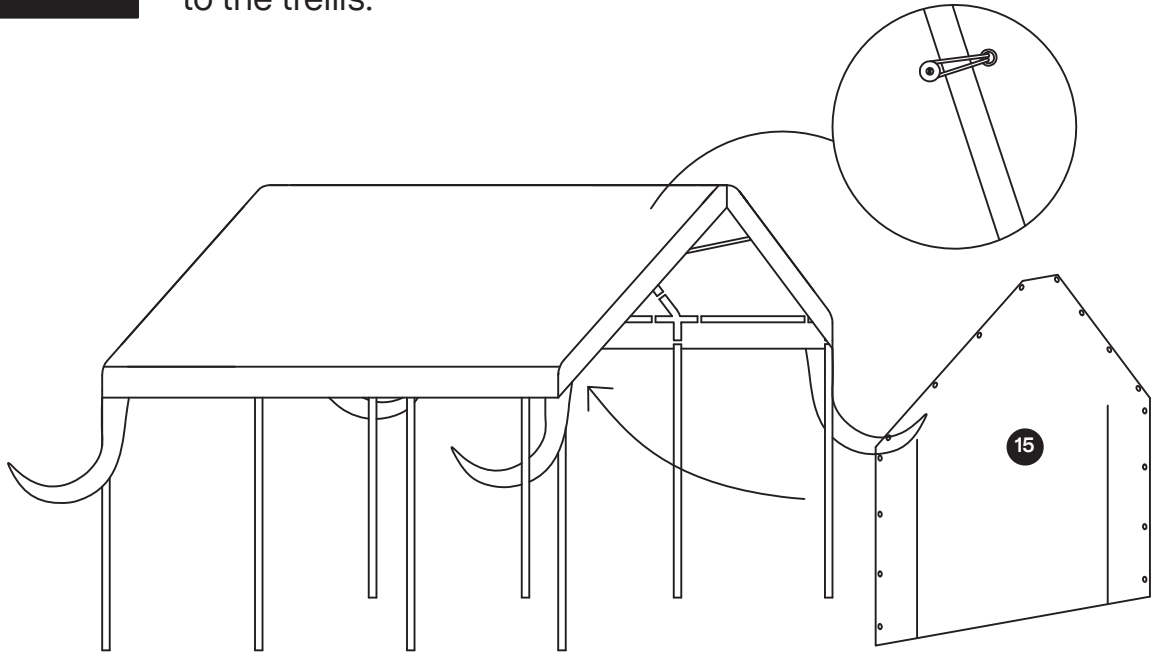

## STEP 7

Connect the lower leg tubes (#4) and the footplates (#8). Use the screws (#11) to fix them. Insert the hooks of the canopy into one of the holes of the lower leg tubes (#4).

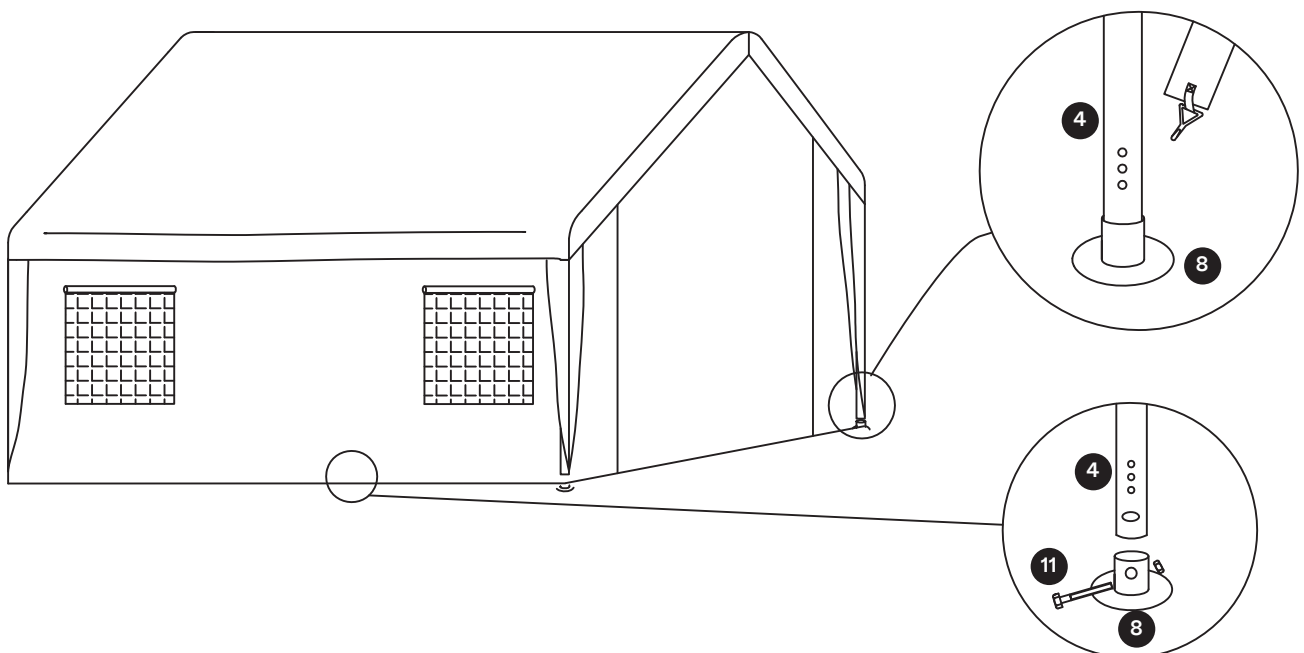

# Assembly Steps

## STEP 8

Insert the ground nails (#9) on the footplates (#8).

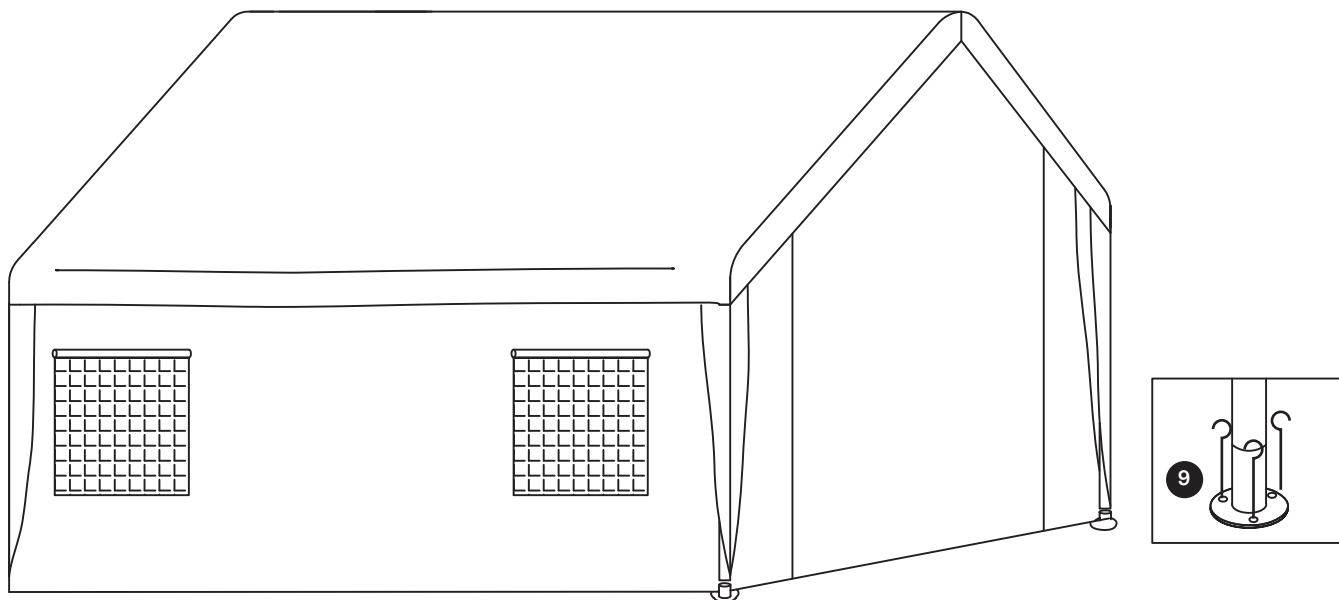

## STEP 9

Install windproof ropes (#17) and ground nails (#13).

(Note: The windproof ropes must be attached to the trellis through the copper ringlets.)

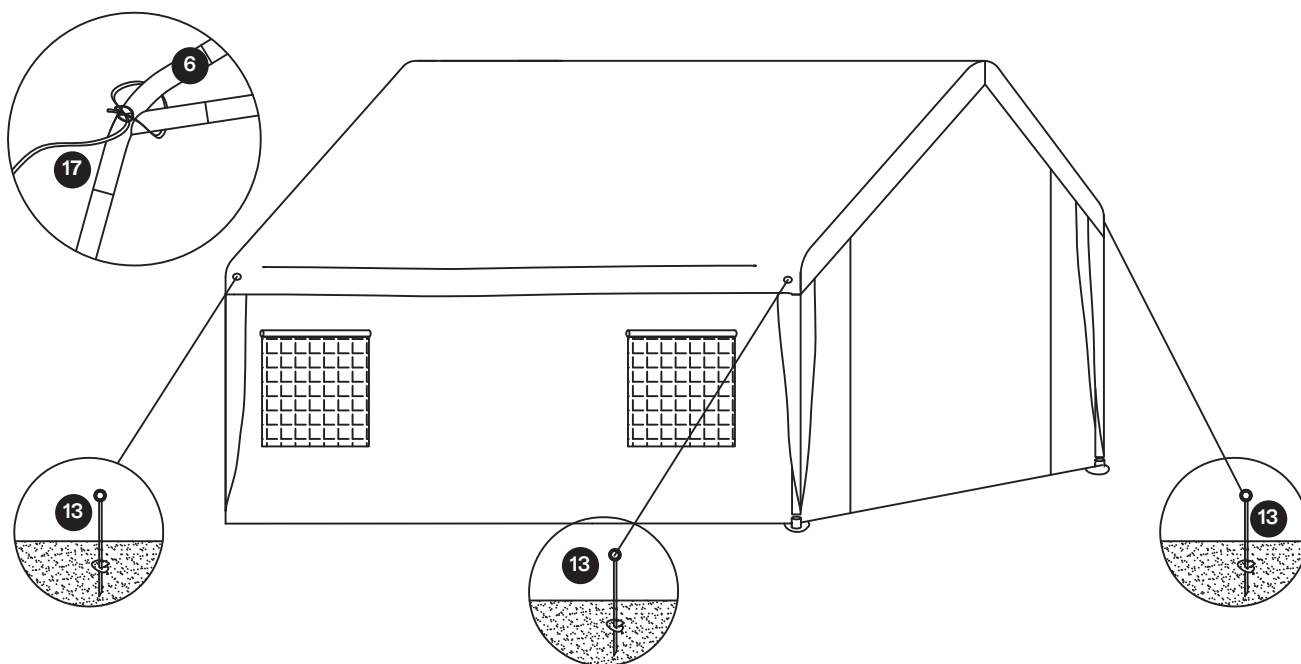

# Assembly Steps

## STEP 10

Place the sandbags (#18) on each foot of the portable garage to secure it.

The assembly finished.

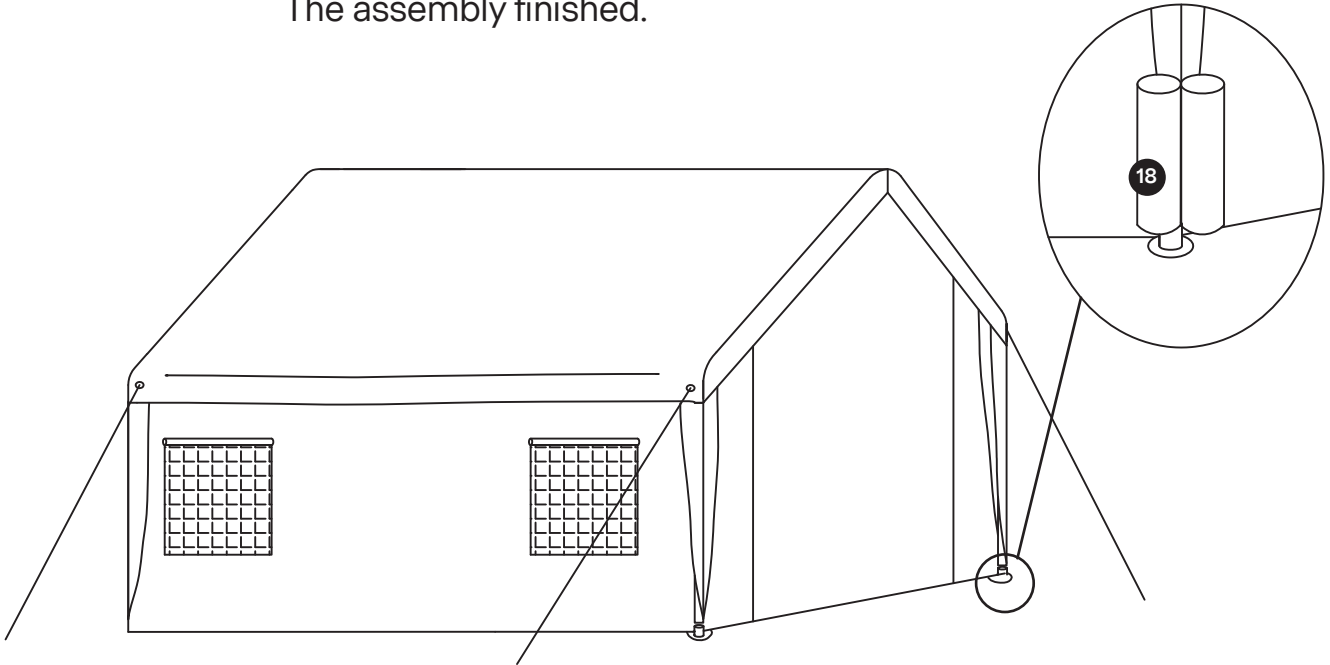

# VIVOHOME

**NOTE:**

To continuously improve its products, VIVOHOME reserves the right to modify this information without prior notification.

For any questions regarding assembly, please watch the video on the product page or contact our customer service. Our customer service will gladly assist you with any additional questions, comments, or concerns.

Thank you for using VIVOHOME products in your home!

**Thank You For Purchasing From  
VIVOHOME**

Made in China