

Assembly Menu

Assembly Menu-Small nest table set of 2

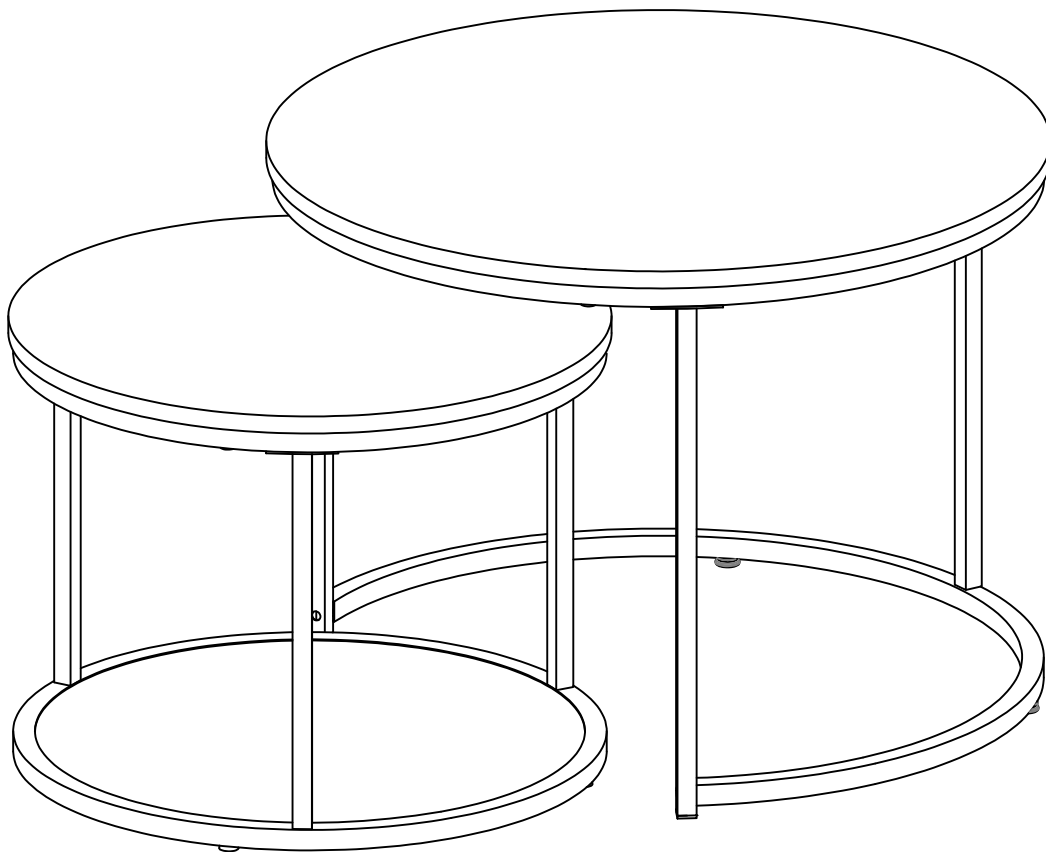

A	x 8
	
M6x28mm	

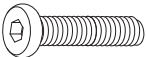
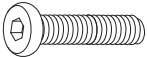

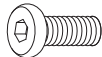

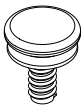

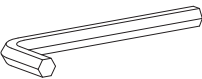
B	x 6
	
M6x35mm	

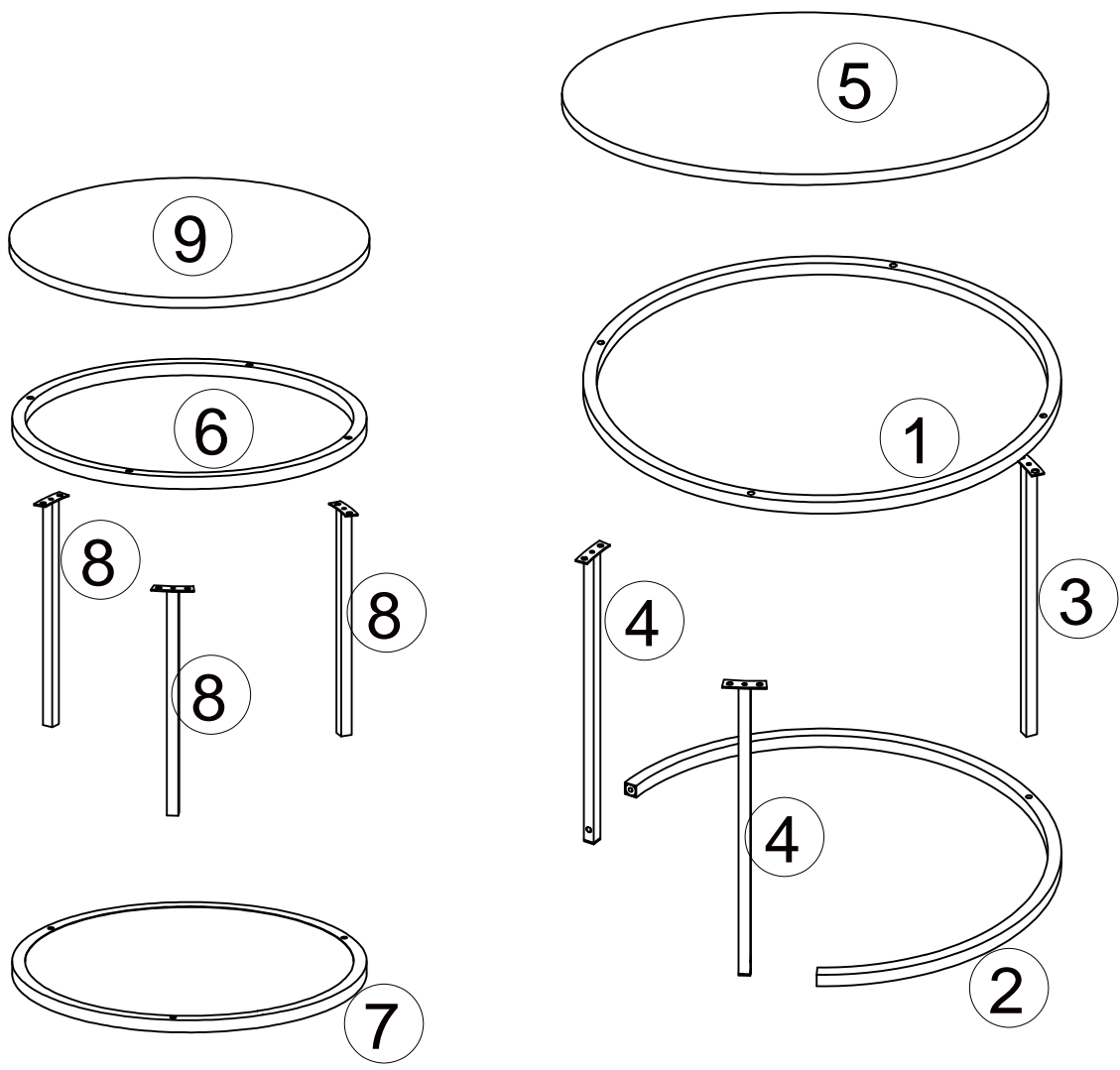
C	x 12
	
M6x10mm	

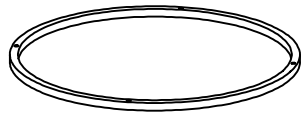
D	x 6
	

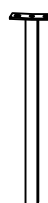
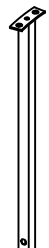
E	x 1
	
4mm	

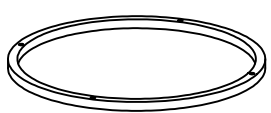
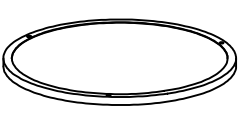
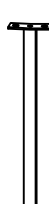

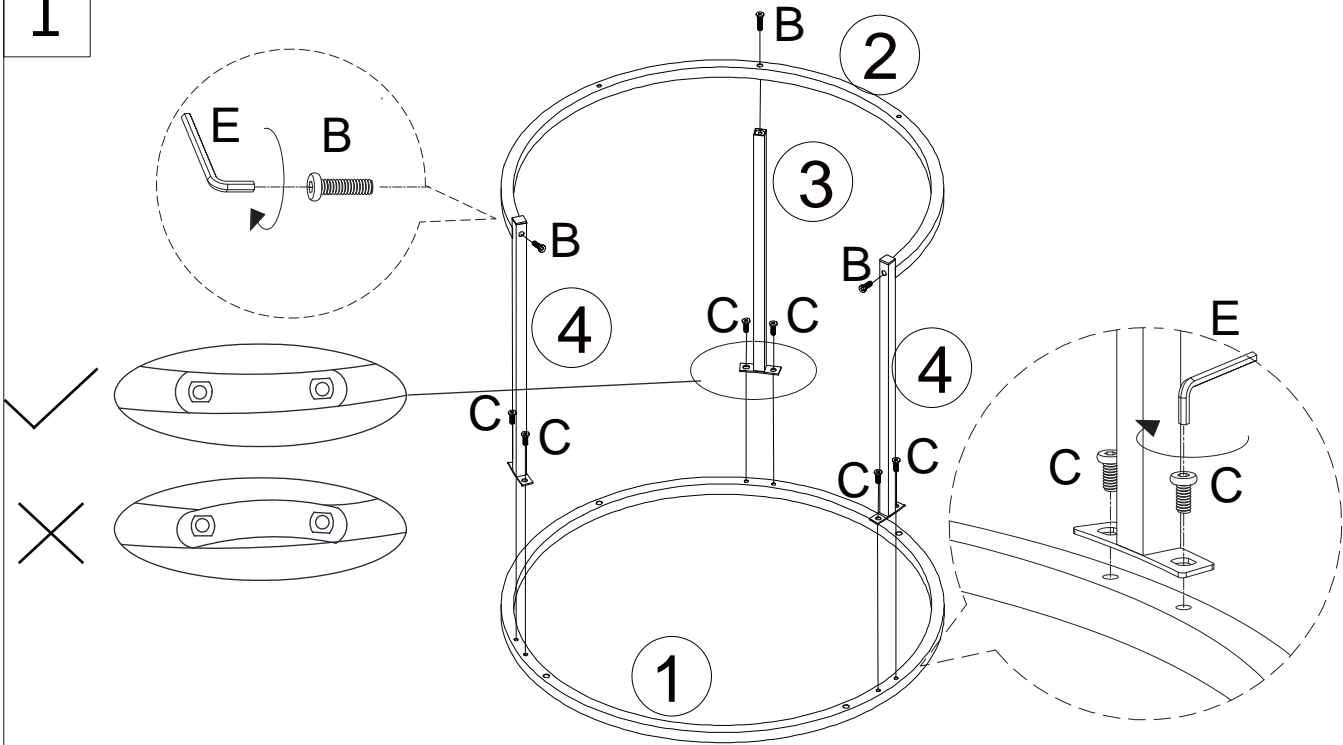

<p>1</p>  <p>1PC</p>	<p>2</p>  <p>1PC</p>	<p>3</p>  <p>1PC</p>
<p>4</p>  <p>2PC</p>	<p>5</p>  <p>1PC</p>	<p>6</p>  <p>1PC</p>
<p>7</p>  <p>1PC</p>	<p>8</p>  <p>3PC</p>	<p>9</p>  <p>1PC</p>

1



B	x 3
	
M6x35mm	

C	x 6
	
M6x10mm	

E	x 1
	
4mm	

2

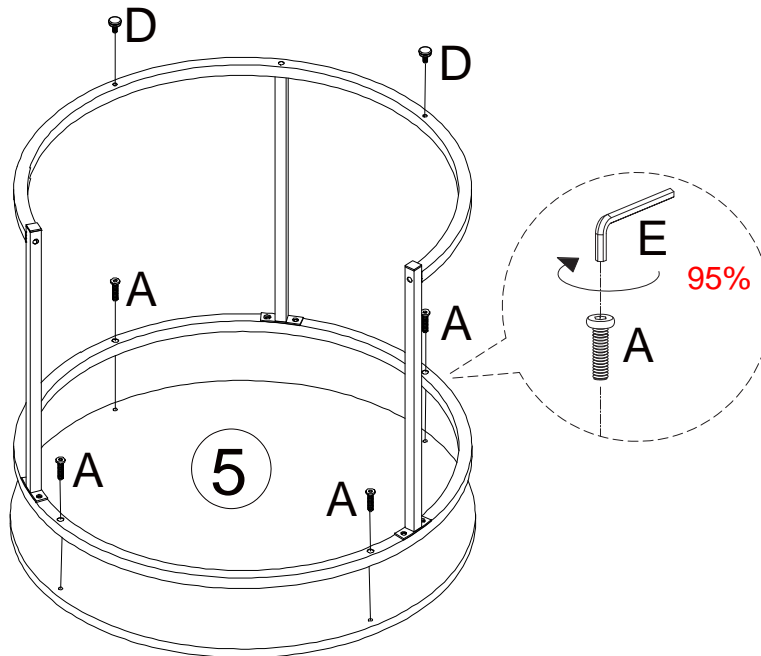

In order not to crack the table top, please not use the screws not longer than 28mm and tight 95%.

A	x 4
	
M6x28mm	

D	x 2
	

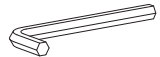
E	x 1
	
4mm	

3

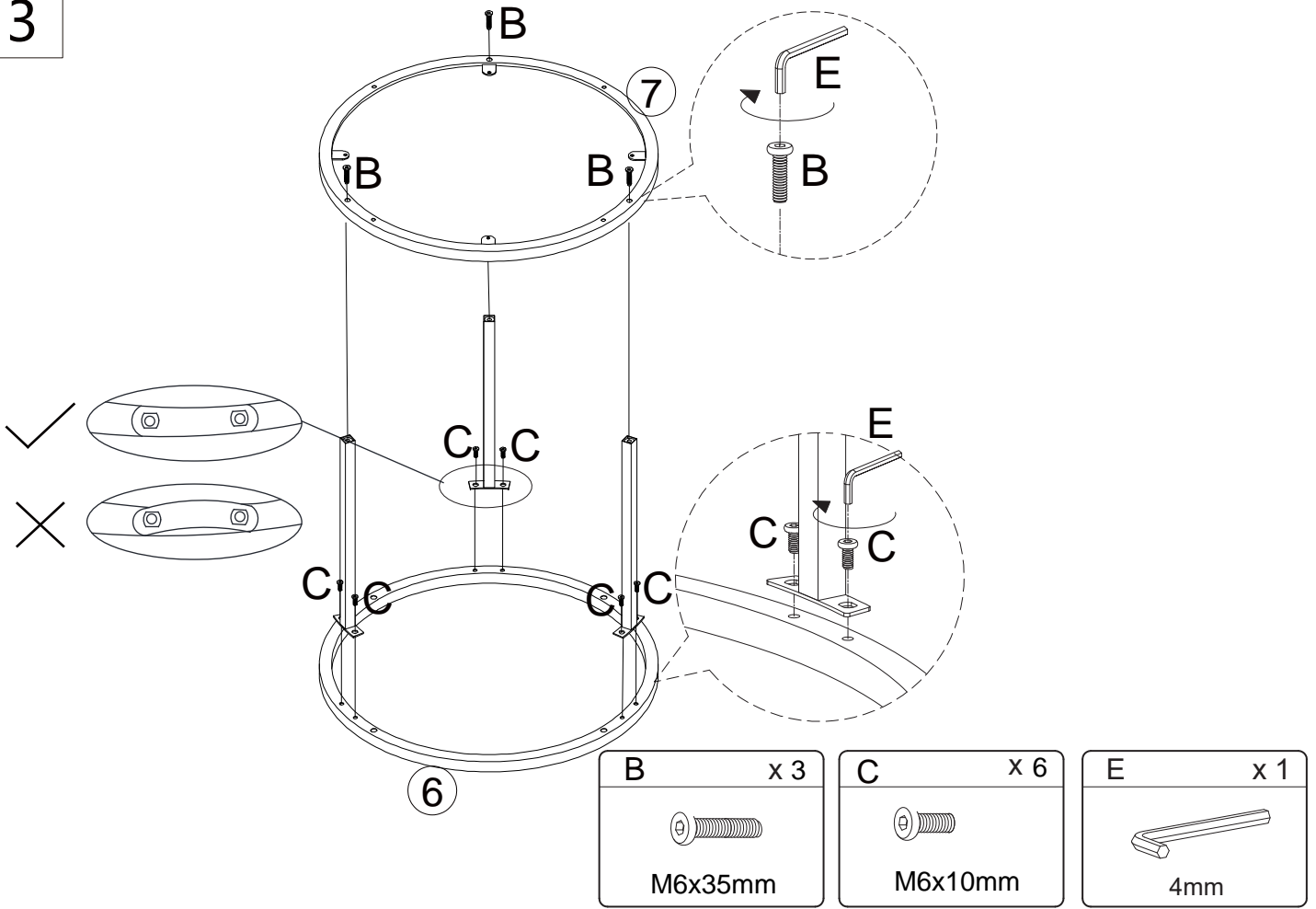

4

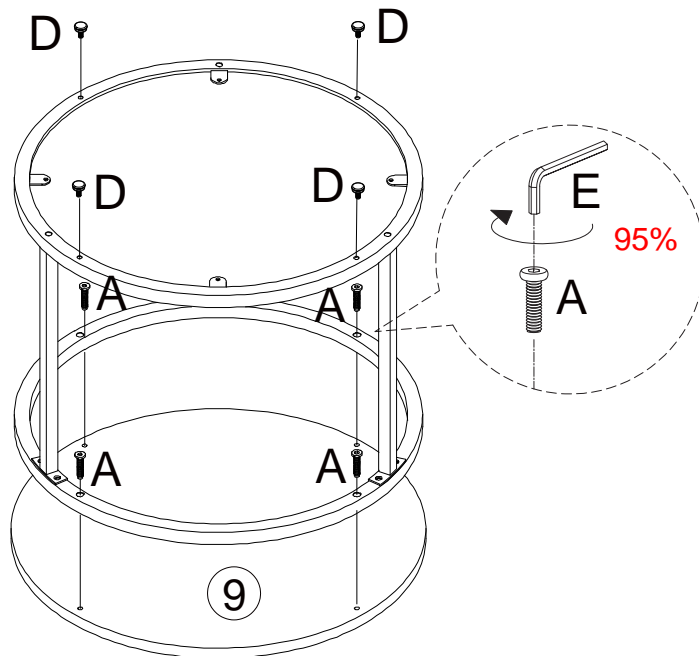

In order not to crack the table top, please not use the screws not longer than 28mm and tight 95%.

