

Assembly Instructions

7006 Sofa Group

Description
SG Recliner P3
Loveseat w/Console P3 & ZG
Sofa P3 & ZG

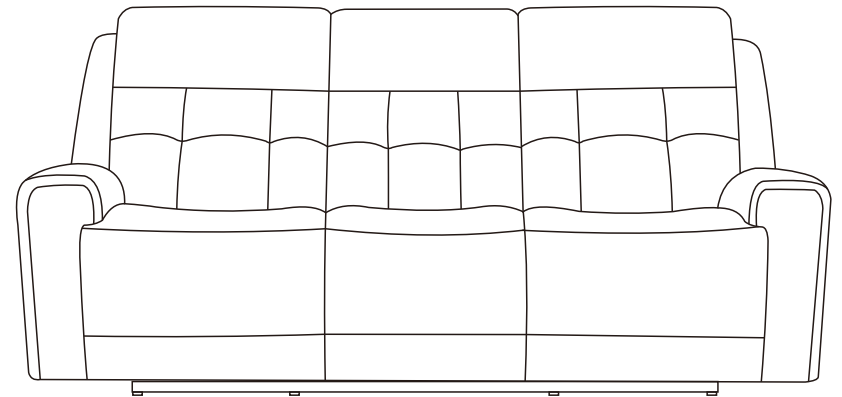
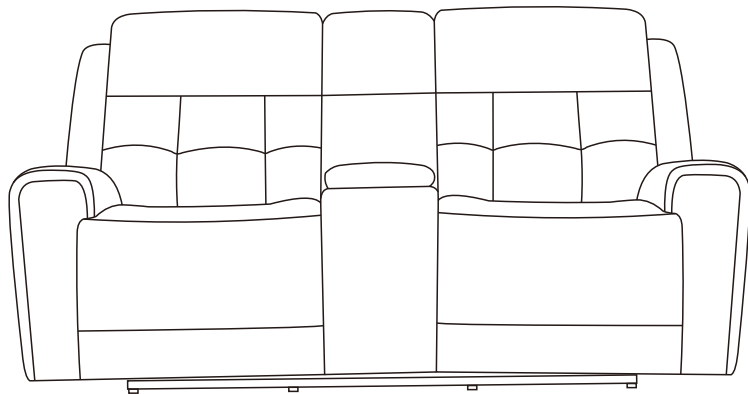
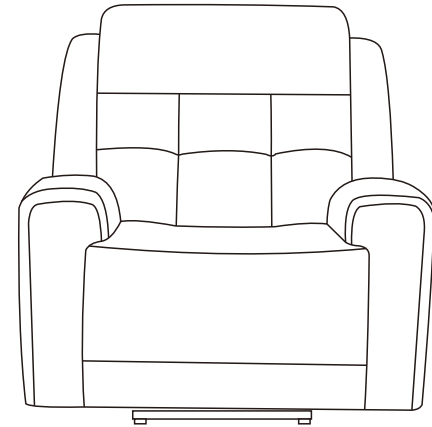

Preparations

Pre-Assembly Preparations

Before starting the assembly, please carefully review this instruction manual to ensure that you can correctly assemble and use this product. Additionally, to prevent any damage to the parts, we suggest that you first check that you have enough space to lay out all the parts.

Furthermore, it is important to assemble the unit on a clean and soft surface to avoid any damage to the parts. Please carefully inspect all parts to make sure there are no small pieces that may have come loose during shipping. Also, please ensure that all parts are present and match the parts list provided on the next page before starting the assembly.

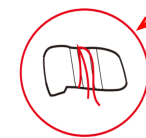
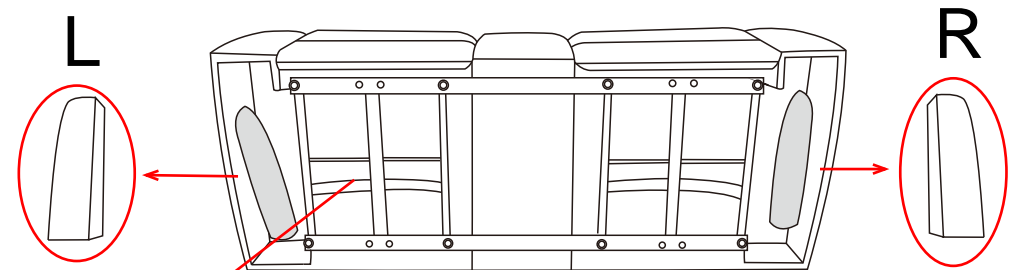

Please take out the wings and power cord located at the bottom of the sofa as shown in the diagram.

(Note: The diagram is shown using the Loveseat as an example; the location of these parts is the same for others)

Wing(L)

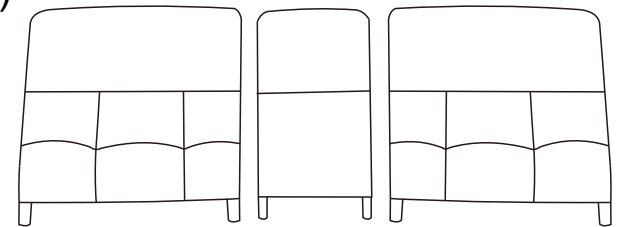



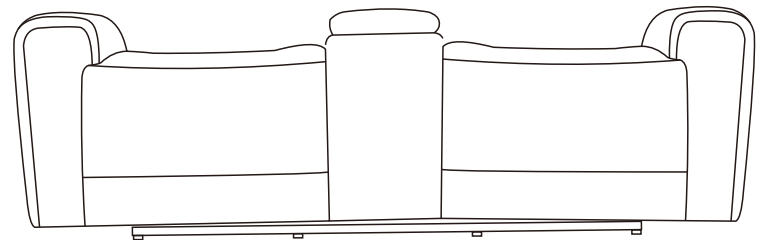

Wing (R)



List of Parts

PART LIST

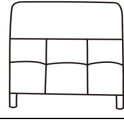
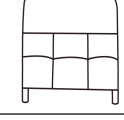
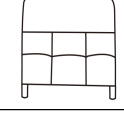
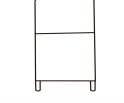
NO	Sketch	Description	Quantity	Quantity	Quantity
			Recliner	Loveseat	Sofa
A		Wing(L)	1	1	1
B		Wing(R)	1	1	1
C		Power cord	1	1	1
D		Back(L)		1	1
E		Back	1		
F		Back(R)		1	1
G		Back(M)			1
H		Back (Console)		1	

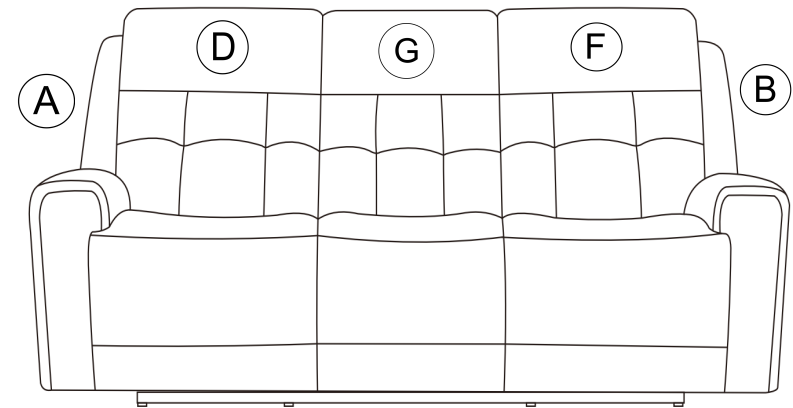
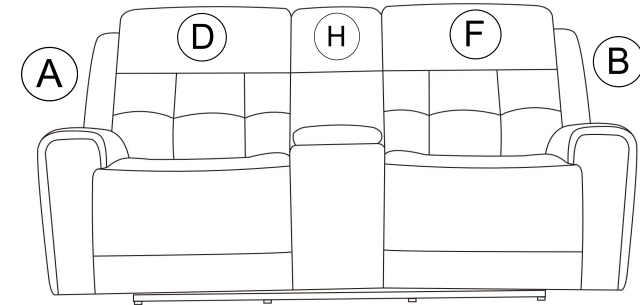
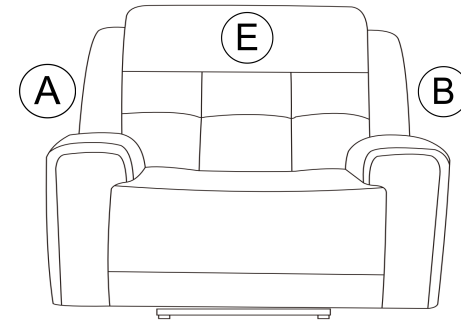

ASSEMBLY INSTRUCTIONS

STEP 1

Attaching the Sofa Back to the Body

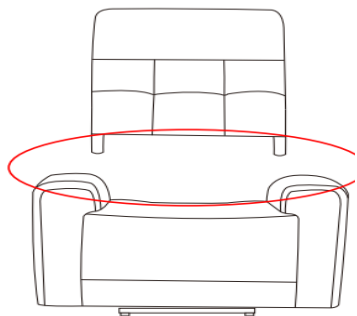

Note: The diagram is provided as an example ; the installation process is the same for other models.

STEP 2

Install the wing

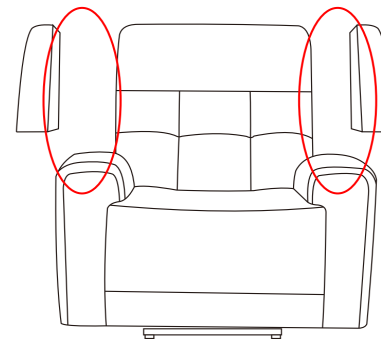

Note: The diagram is provided as an example ; the installation process is the same for other models.

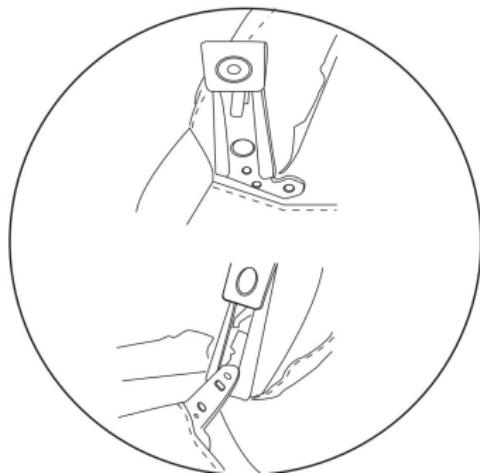

Please read the manual carefully. Find the connection slot marked in the diagram with a red circle.

After confirming the correct installation position, align the slot on the backrest with the one on the sofa body according to the diagram. Gently press down to secure the fit.

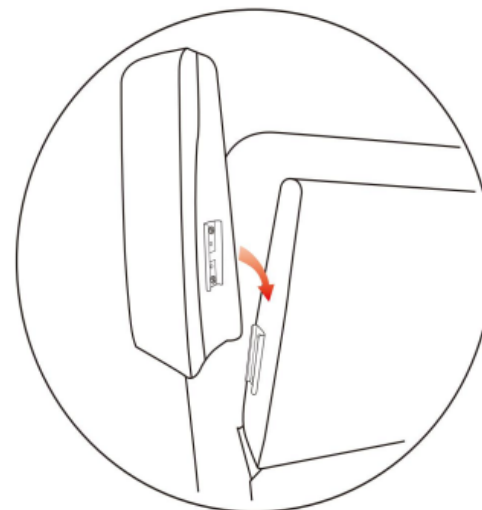

At the red circle in the picture, you can easily find the bracket used to connect the wing and the back.

Make sure to install the wing correctly on the left and right sides before connecting the bracket according to the diagram.

ASSEMBLY INSTRUCTIONS

STEP 3/4/5

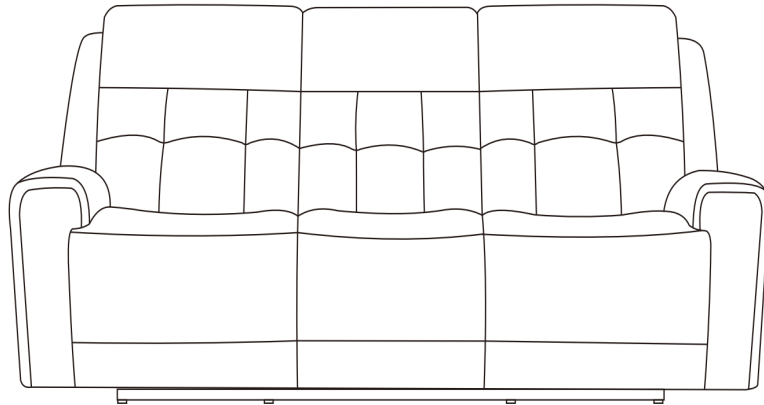
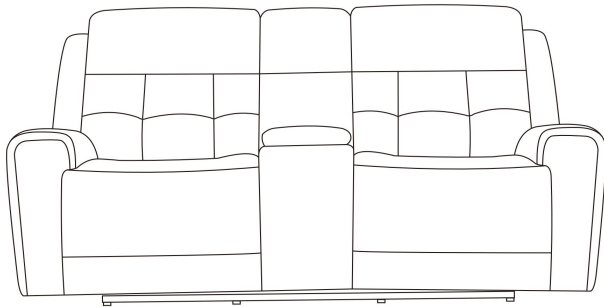
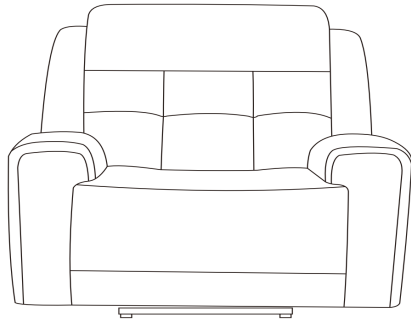

Connect the power port

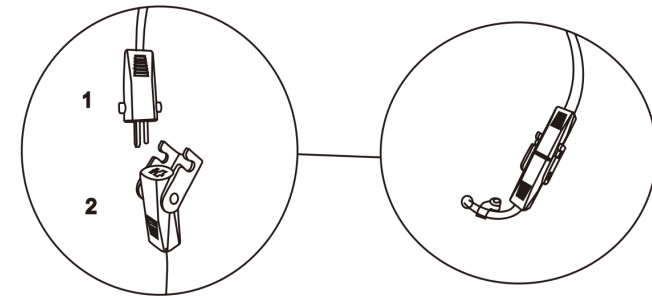
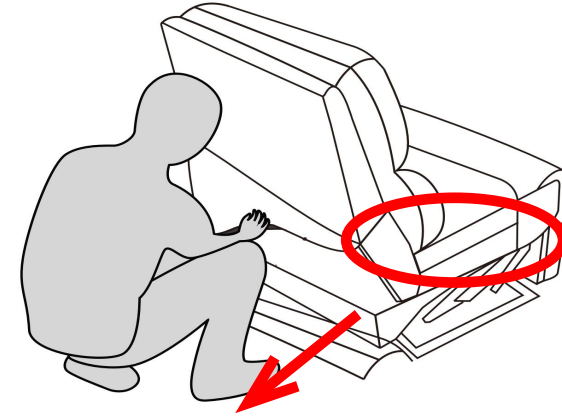

Please locate power port 1 and power port 2 at the red circles indicated in the figure. Check the size of each port before connecting them together.

ASSEMBLY INSTRUCTIONS

Fasten the Velcro

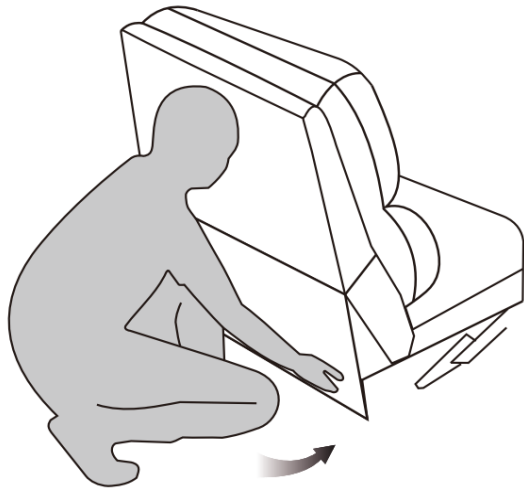

Attach the Velcro on the back of the sofa.

Connect the power supply

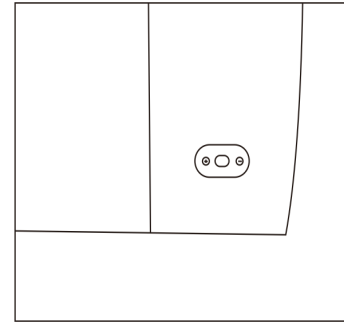

Located at the bottom of the back of the sofa.

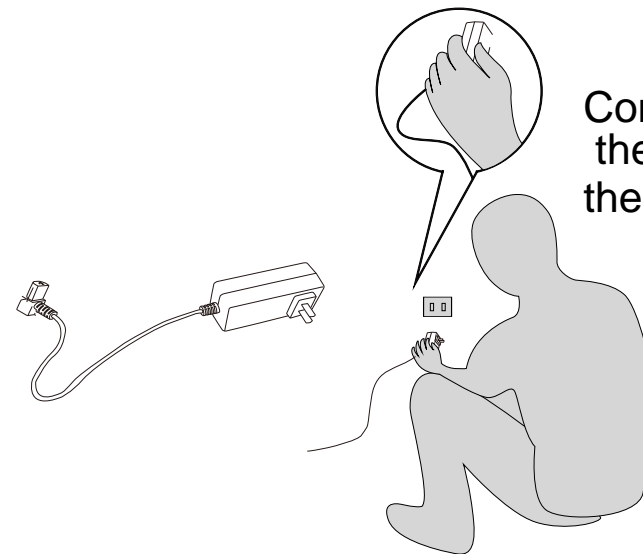

Connect the adapter to the sofa as shown in the diagram.

Functions Buttons

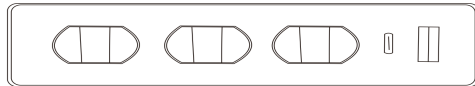
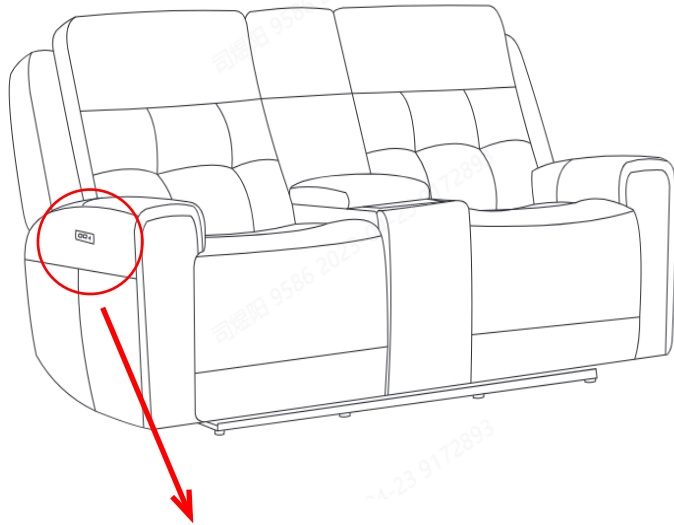

Note: The diagram is shown using the Loveseat as an example.
The location of this part is the same for others.

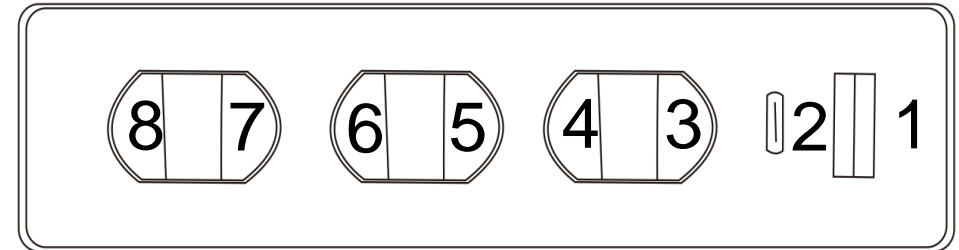

Location	Function
1	USB Port
2	Type-C Port
3	Seat Forward
4	Home Button
5	Lumbar Forward
6	Lumbar Backward
7	Headrest Forward
8	Headrest Backward