

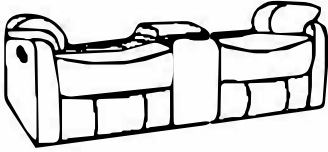
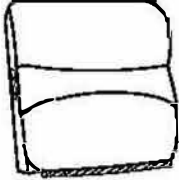
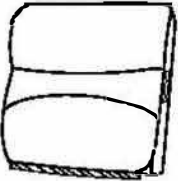
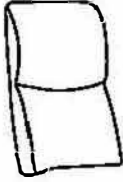
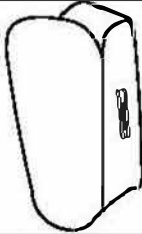

ASSEMBLY INSTRUCTION

LAY FLAT DOUBLE RECLINING LOVE SEAT WITH CONSOLE

NOTE: Do not use power tools for assembly. Power tools increase the risk of over tightening which lead to splitting or cracking the wood.

PART LIST

NO.	DRAWING	QTY	DESCRIPTION
A		1	SEAT
B		1	LSF BACK REST
C		1	RSF BACK REST
D		1	CONSOLE BACK
E		1	LSF EAR
F		1	RSF EAR

Please follow the drawings below to assemble the item

Step 1: Console back is stored in the plastic bag and put in bottom of console. please take out for assembly.

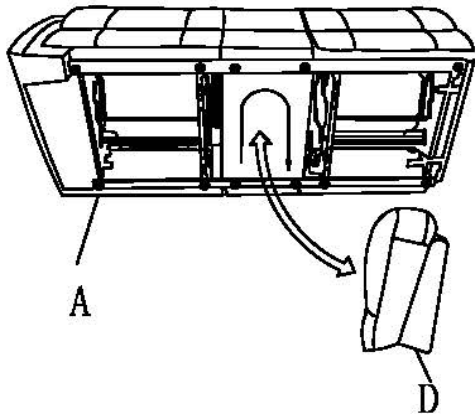

Step 2: Align the metal bracket F at the back rest onto the metal bracket M at the seat, insert and push to the end, make sure the metal bracket F+M are secured in position.

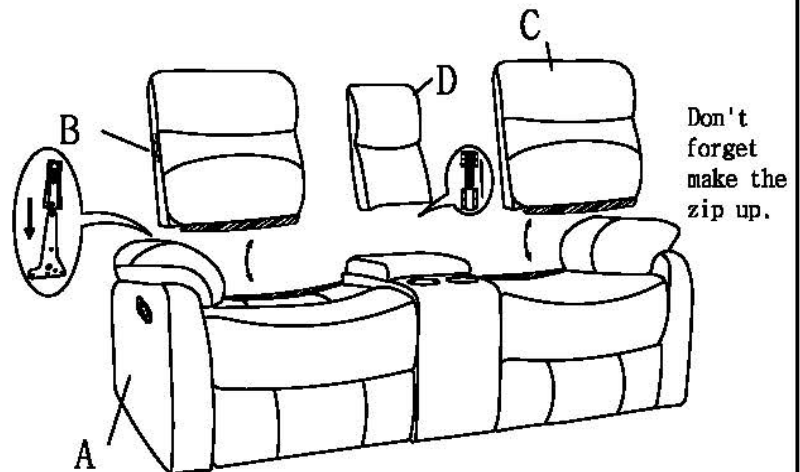

Step 3: Please insert the LSF ear and RSF ear to the back rest and make sure it is secured in position.

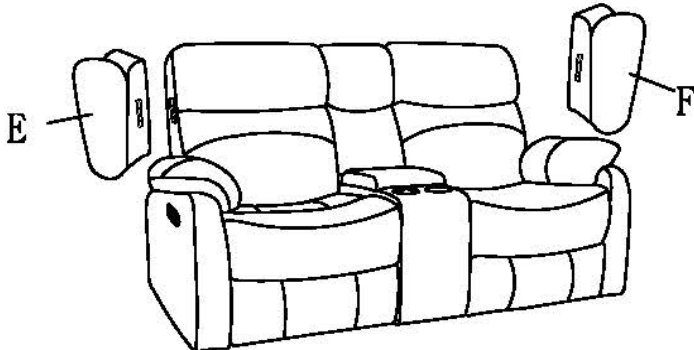

Step 4: Completed.

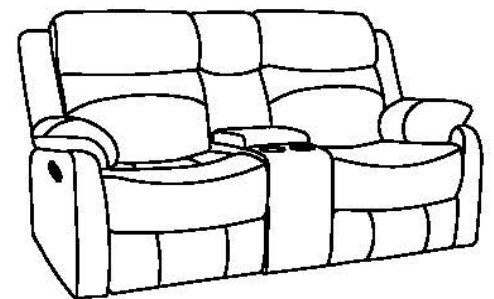

CARE INSTRUCTION FOR POLISHED MICROFIBER FURNITURE

- Avoid exposing furniture directly to sunlight or heating and air conditioning outlets. Exposure to sunlight or heating and air conditioning outlets will fade/damage polished microfiber.
- Wipe gently with a damp soft cloth to remove dust, dirt and any grime buildup.





For items use on wooden floor, hard surfaces or carpets, it is recommended to install protective pads under all legs and supports to avoid/prevent from damages/scratches and discoloration.

ASSEMBLY INSTRUCTION

LAY FLAT DOUBLE RECLINING SOFA WITH DROP-DOWN CUP HOLDERS

NOTE: Do not use power tools for assembly. Power tools increase the risk of over tightening which lead to splitting or cracking the wood.

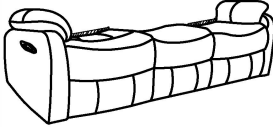
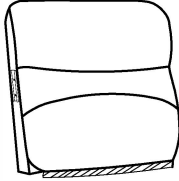
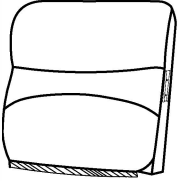
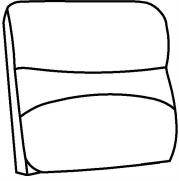
PART LIST

NO.	DRAWING	QTY	DESCRIPTION
A		1	SEAT
B		1	LSF BACK REST
C		1	RSF BACK REST
D		1	MIDDLE BACK REST
E		1	LSF EAR
F		1	RSF EAR

Please follow the drawings below to assemble the item

Step 1: Align the metal bracket F at the back rest onto the metal bracket M at the seat, insert and push to the end, make sure the metal bracket F+M are secured in position.

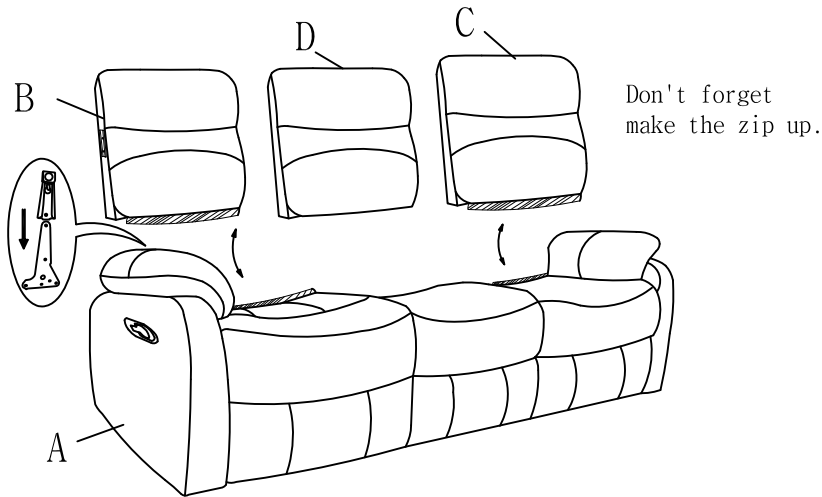

Step 2: Please insert the LSF ear and RSF ear to the back rest and make sure it is secured in position.

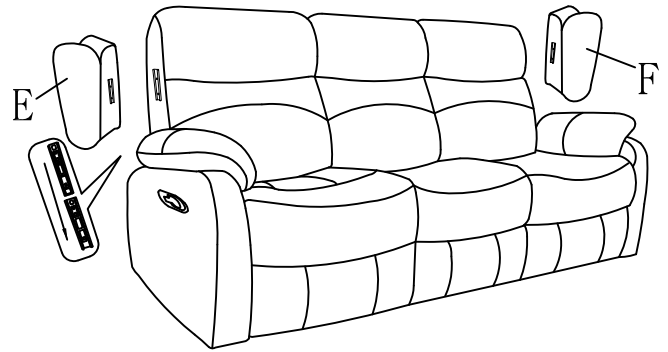

Step 3: Completed.

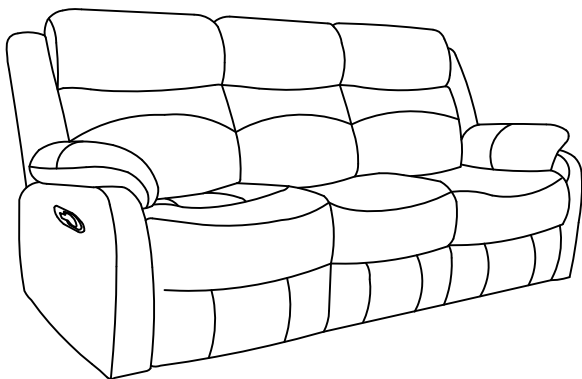

Step 4: Pull the middle back rest to the seat to use cup holder function.

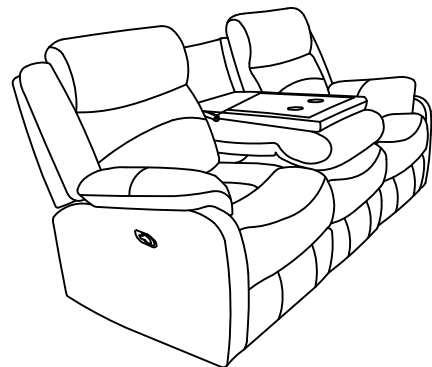

CARE INSTRUCTION FOR POLISHED MICROFIBER FURNITURE

- Avoid exposing furniture directly to sunlight or heating and air conditioning outlets. Exposure to sunlight or heating and air conditioning outlets will fade/damage polished microfiber.
- Wipe gently with a damp soft cloth to remove dust, dirt and any grime buildup.



For items use on wooden floor, hard surfaces or carpets, it is recommended to install protective pads under all legs and supports to avoid/prevent from damages/scratches and discoloration.