

HULALA

HOME

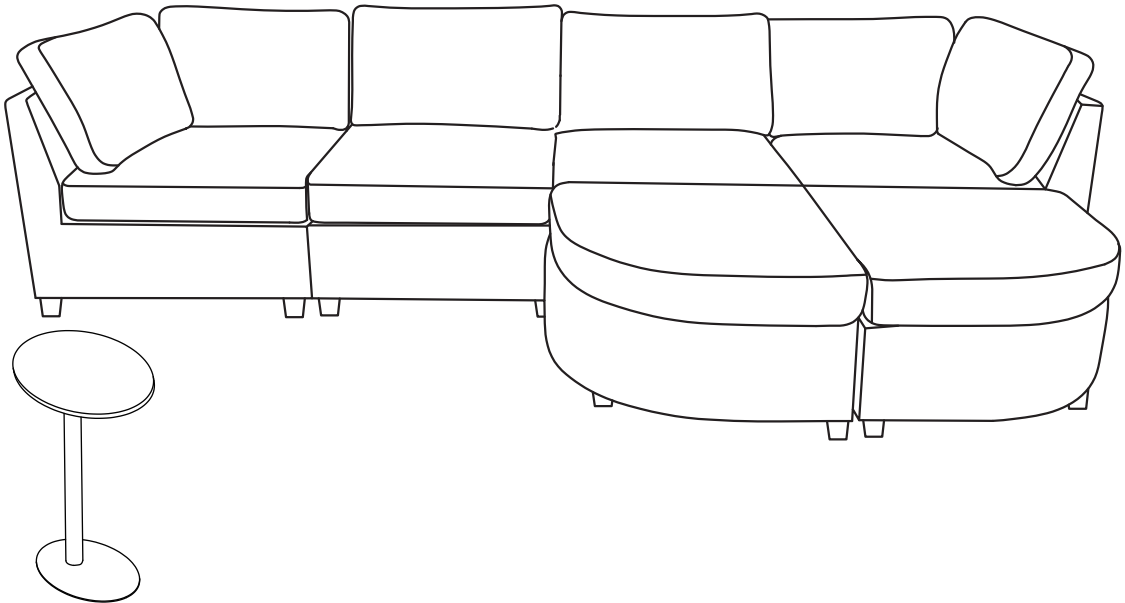

Per Seat Weight Limitation

1400LBS

ITEM NO. SFJL1057

Thank You For Choosing Our Furniture

- ▀ If you have any questions or concerns, don't hesitate to reach out to us. ▀

Call us: +1(833)324-2464
Email: hello@hulalahome.com

NOTE:







This brochure contains **IMPORTANT** safety info. Please read and keep it for future reference.

MAINTAINANCE AND WARNINGS



Before You Start

Please follow the steps below:



-  Un box the package and check if all parts and accessories are complete.
-  Place the parts of the sofa on a flat surface.
-  Ensure the sofa is placed on a stable, flat surface to prevent it from tilting.
-  Avoid placing sharp or heavy objects directly on the sofa to prevent tears or deformation.
-  Follow the assembly instructions provided to attach the cushions, backrest, and armrests securely.
-  Clean the installation area in advance and ensure the ground is level and there is enough space to avoid damaging the furniture or making installation difficult.
-  Lay a protective mat on the ground to prevent scratching the floor during installation.

After-Sales Service

- If you encounter any issues or need technical support during use, please contact our after-sales team. We offer long-term maintenance and warranty services.





Precautions

-  This sofa is for indoor use only. Do not expose it to outdoor elements or high-humidity environments.
-  Keep the product away from high heat or open flames to prevent fire hazards.
-  Do not allow children or pets to play on the sofa unsupervised to avoid accidents.



Safety Warnings





-  If you notice any loose or damaged parts, stop using the sofa immediately and contact customer service.
-  Do not attempt to disassemble or replace any components yourself, as this may affect the stability and safety of the product.

Daily Maintenance

- Regularly clean the surface of the sofa with a soft cloth to prevent dust accumulation.
- For fabric sofas, it is recommended to vacuum weekly and clean the fabrics as needed.
- For leather sofas, use a leather cleaner regularly to clean and maintain the material. Avoid direct sunlight to prevent leather aging.
- In case of spills, immediately blot the area with a clean, dry cloth

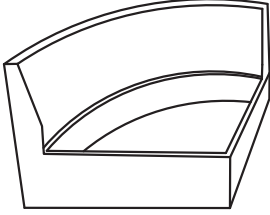
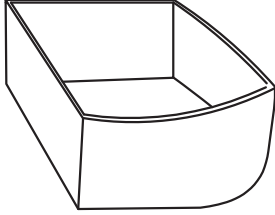
Parts List

BOX-A

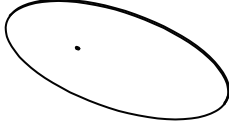
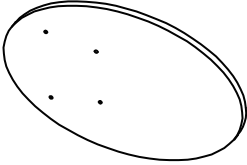
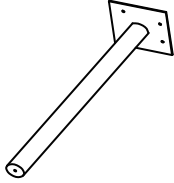
<p>A</p>  <p>x1</p> <p>Edge position</p>	<p>C</p>  <p>x1</p> <p>Pedal position</p>
<p>D</p>  <p>x2</p> <p>Seat cushion</p>	<p>G</p>  <p>x2</p> <p>Back cushion</p>
<p>J</p>  <p>x8</p> <p>Legs</p>	<p>H</p>  <p>x1</p> <p>Table bottom plate</p>
<p>I</p>  <p>x1</p> <p>Table</p>	<p>K</p>  <p>x1</p> <p>Table support</p>



Installation:
30minutes.



Two Person

Parts List

BOX-B

A

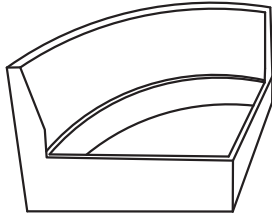

x1

Edge position

C

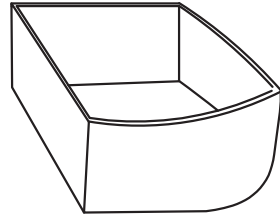

x1

Pedal position

D

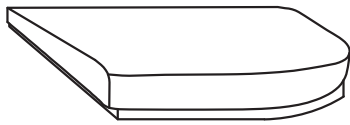

x2

Seat cushion

G



x2

Back cushion

G



x8

Legs

Parts List

BOX-C

B

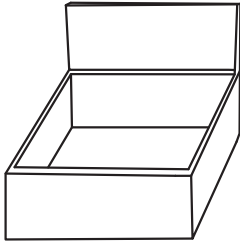

x2

Middle position

E

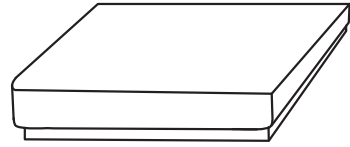

x2

Seat cushion

F

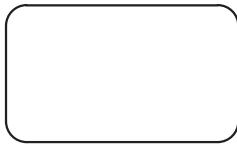

x2

Back cushion

J





x8

Legs

Hardware List

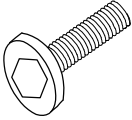
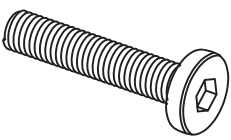
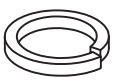
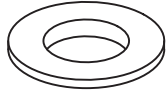
BOX-A

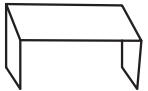
<p>1</p>  <p>x4+1</p> <p>1\4x16MM</p>	<p>2</p>  <p>x1+1</p> <p>M8x25MM</p>	<p>3</p>  <p>x4+1</p>
<p>4</p>  <p>x4+1</p>	<p>5</p>  <p>x1</p>	<p>6</p>  <p>x12</p> <p>Matal shap</p>

THREE TYPES OF SEATS

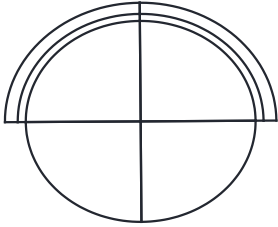

Type A
Two-Seater

Page 8-13

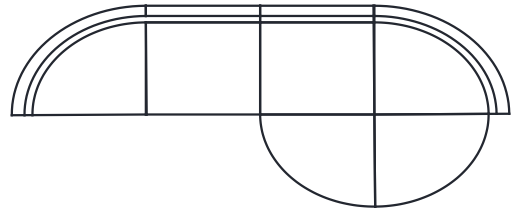



Type B
Six-Seater

Page 8-13

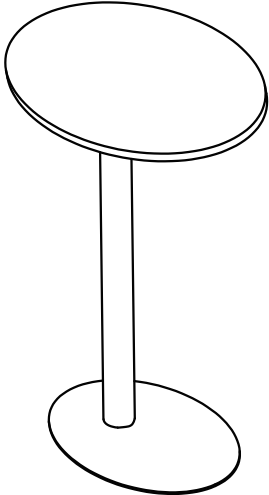
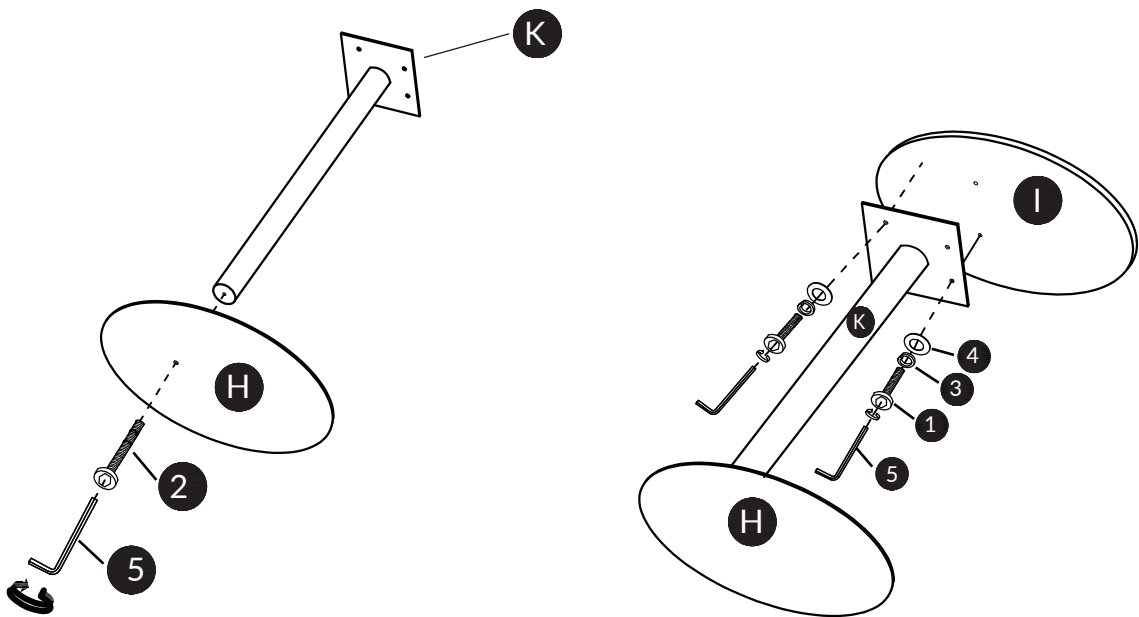
Step 1

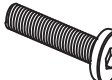
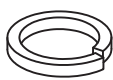

1	x4	2	x1	3	x4	4	x4	5	x1
									
1\4x16MM		M8x25MM							

Step 2

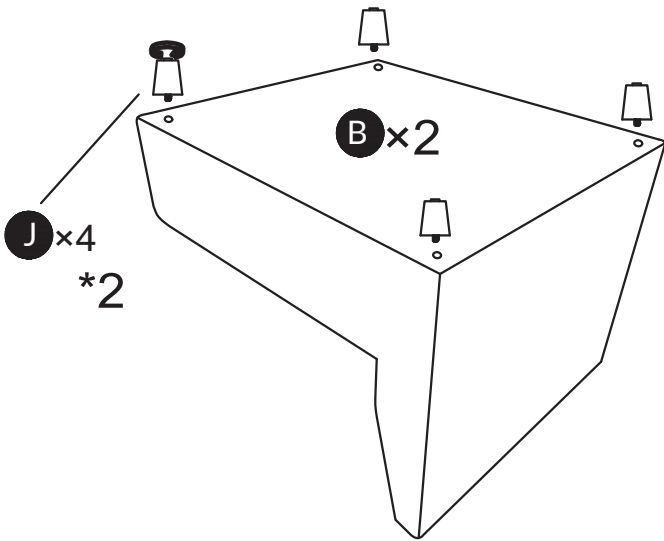
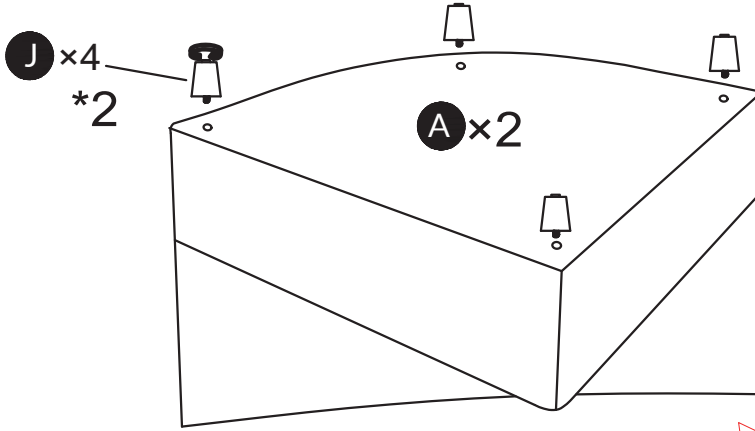

Facedown seat frame
(A/B/C) x 2

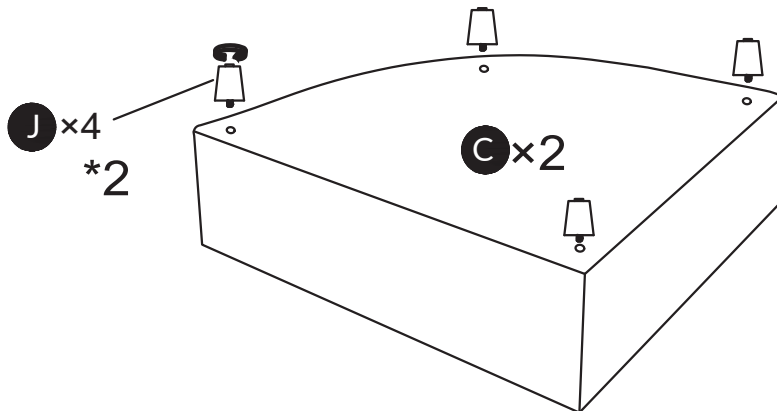

Step 3

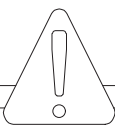

Both Edge position and Edge position are side-to-side interchange.

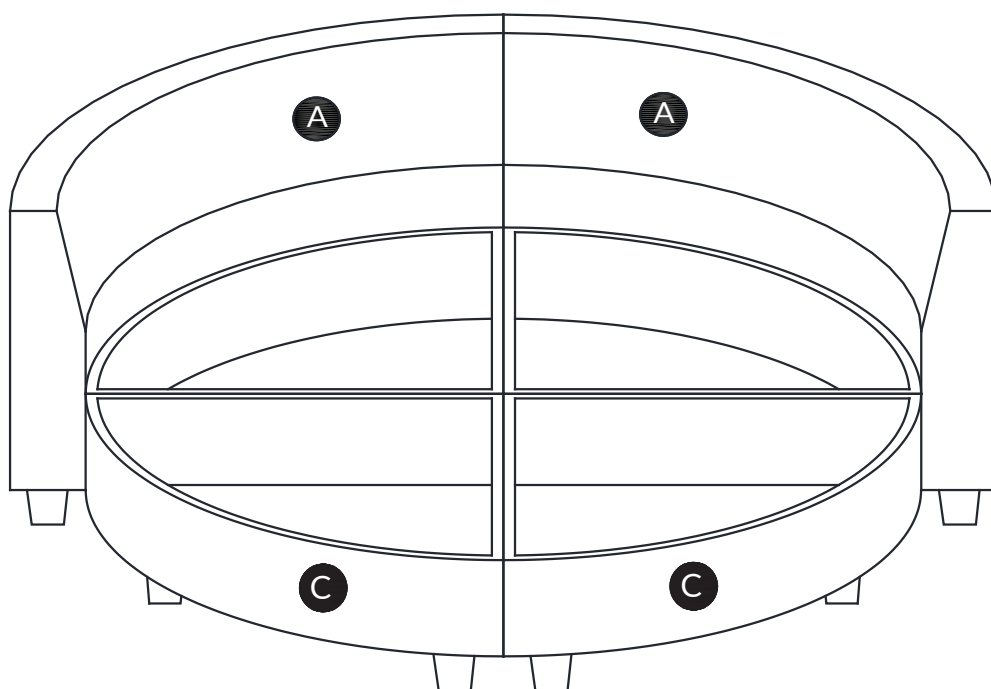
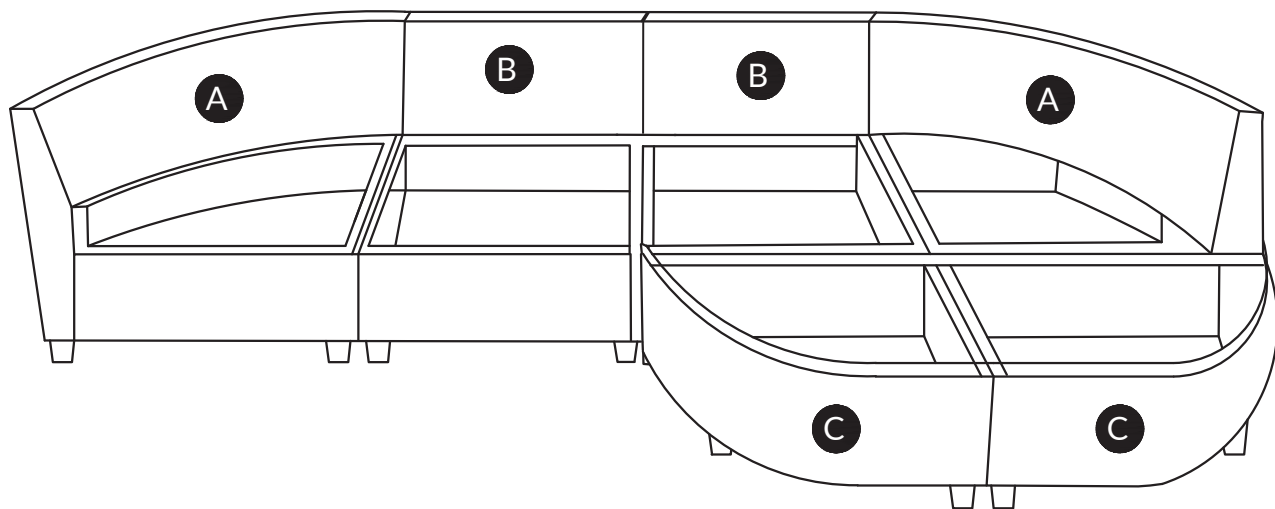

Step 4



Secure the ABCs with metal clasp

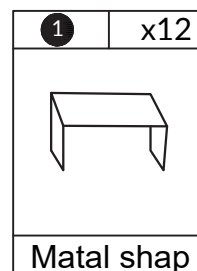
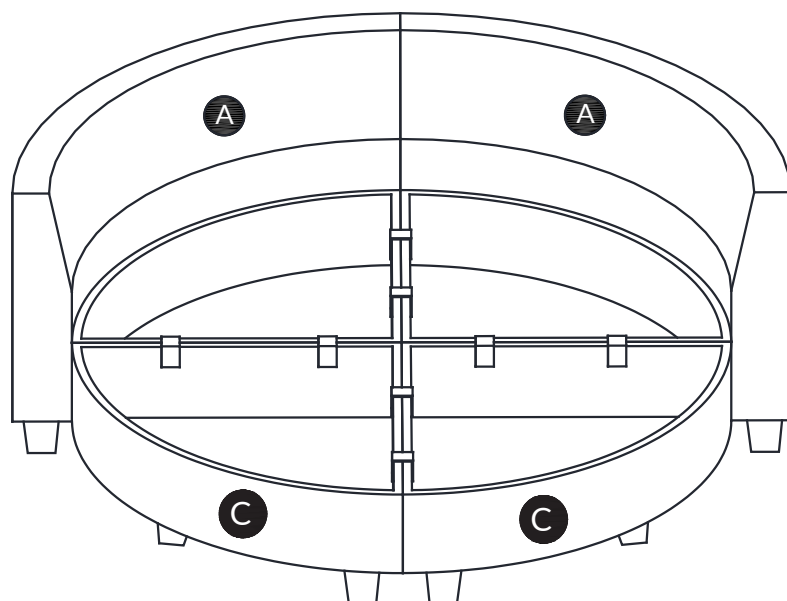
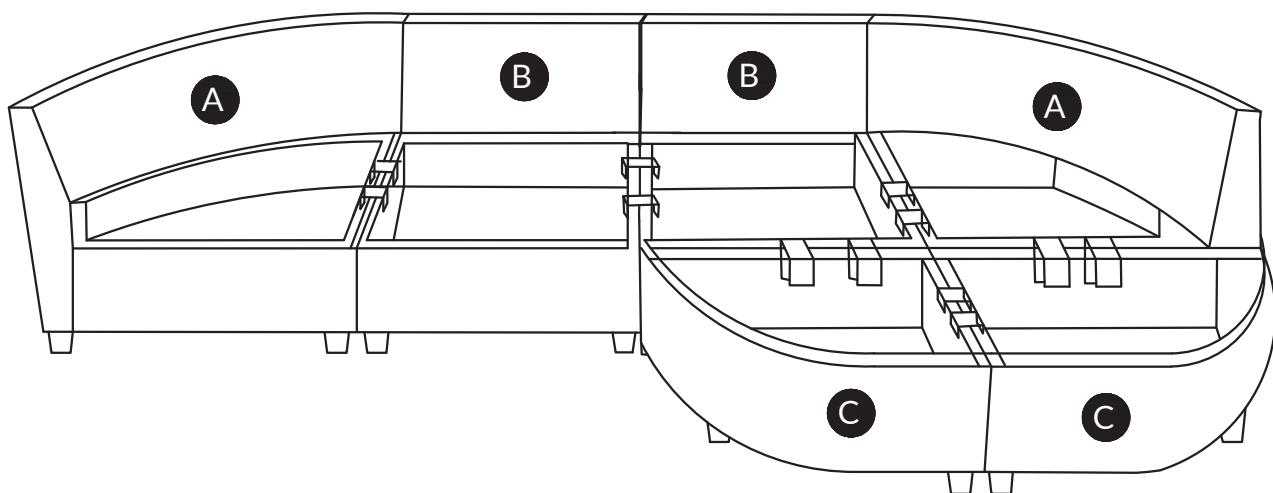

Step 5

Edge position and Edge position's
Seat cushion are interchangeable.

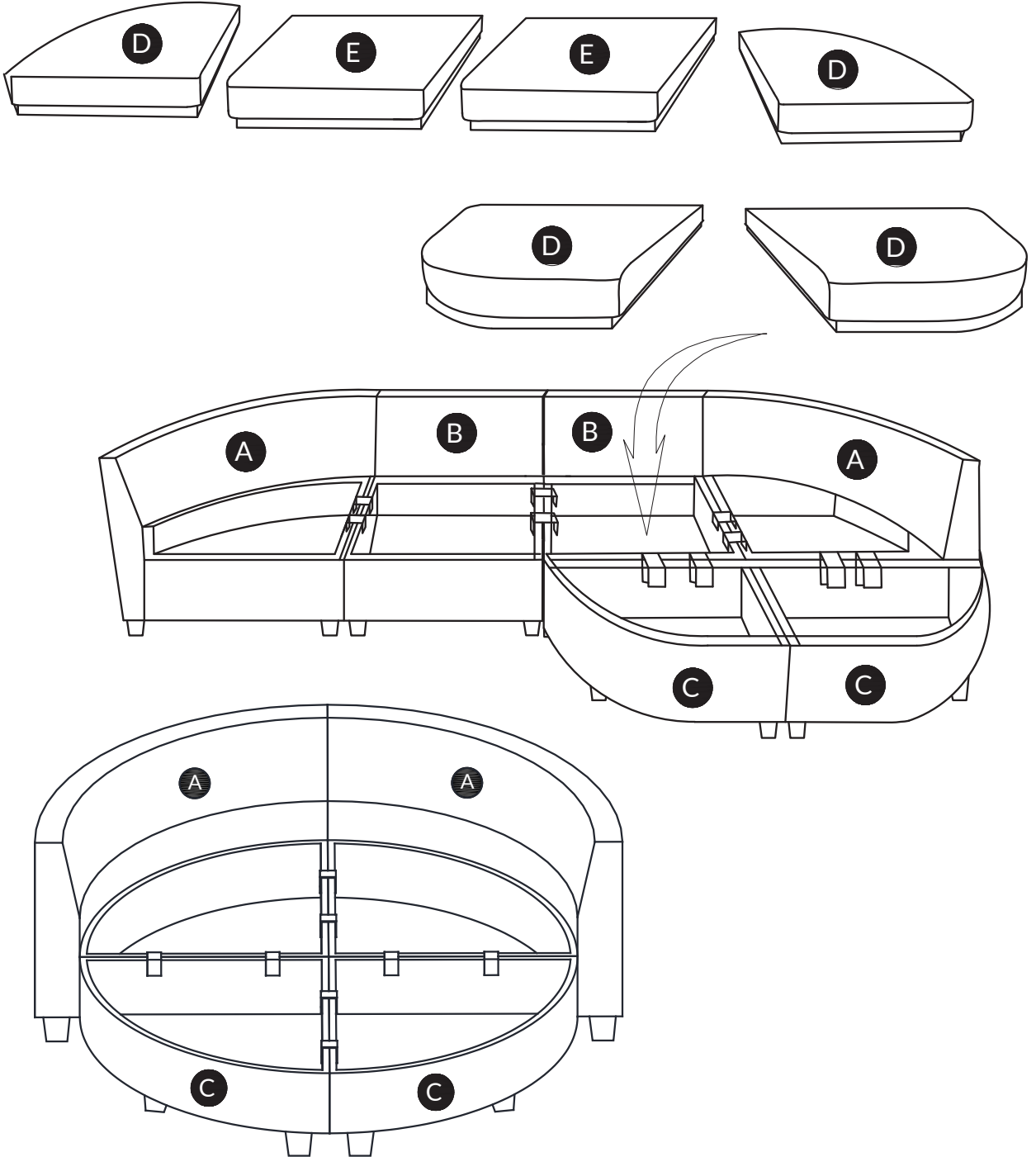

Step 6

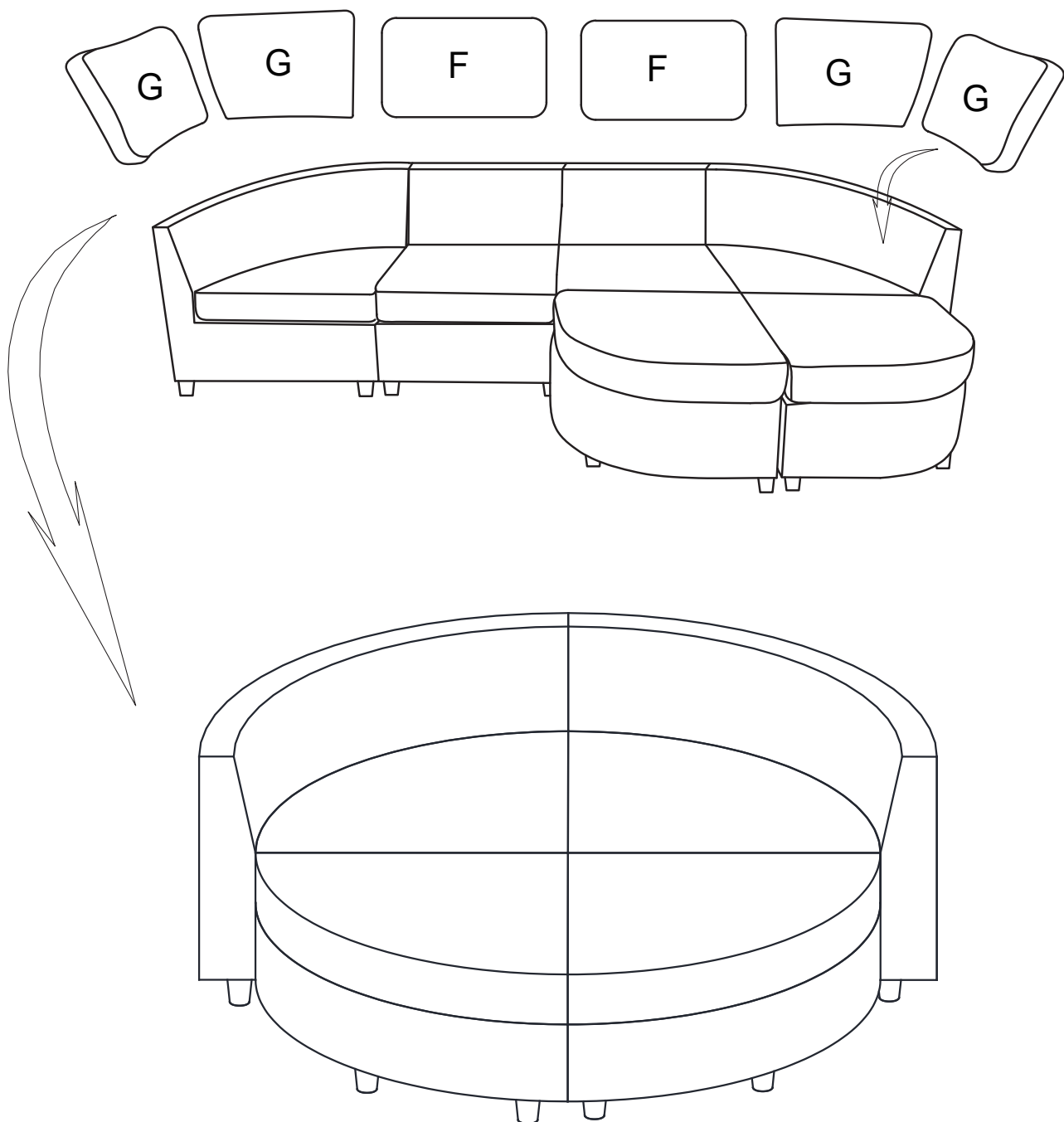

Step 7

Assemble Step-A

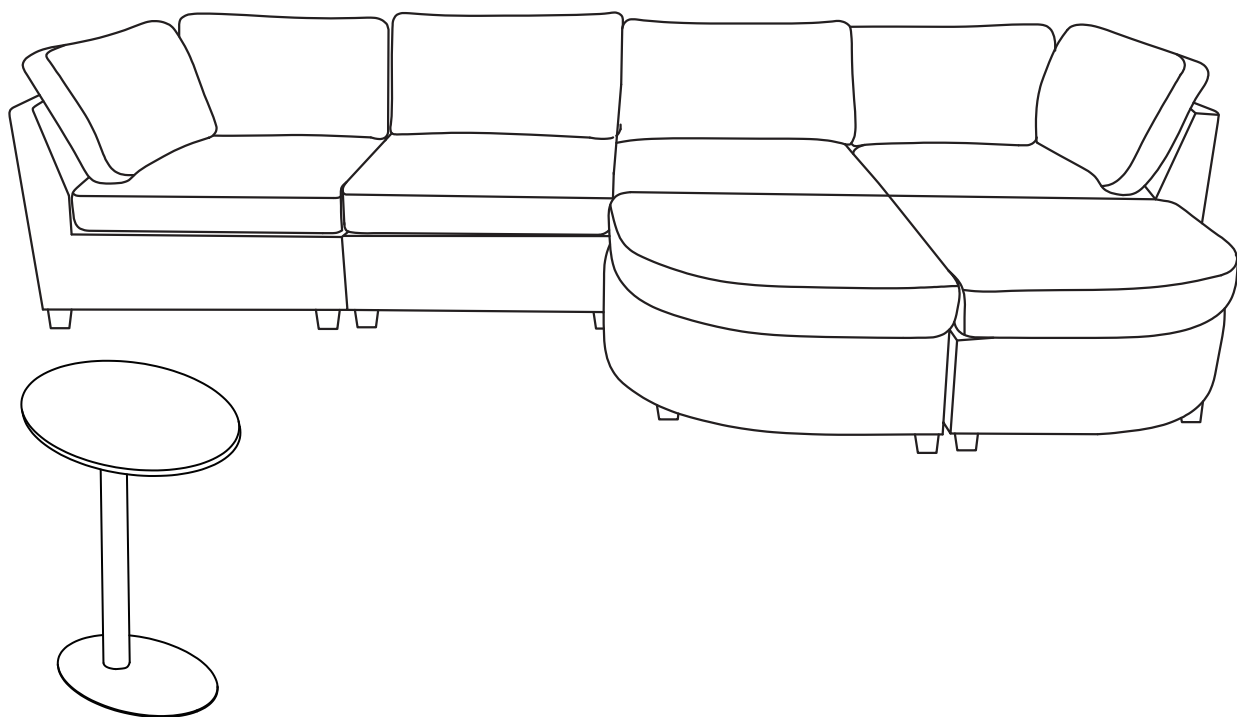

Assemble Step-B

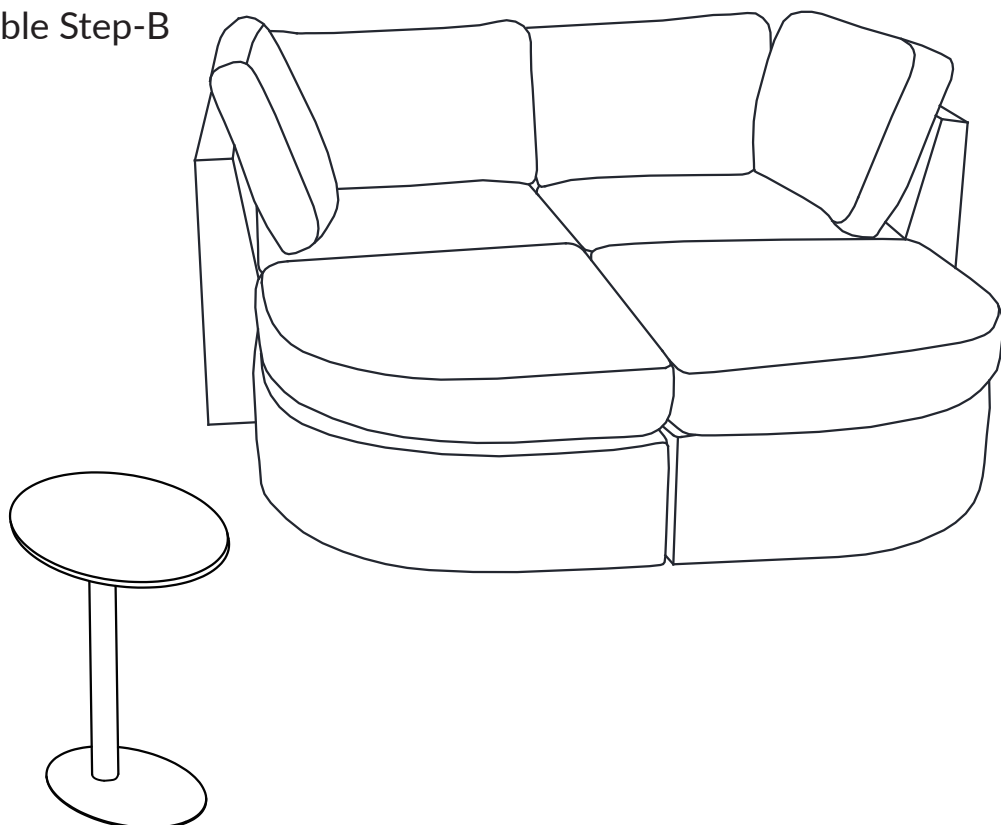

WARRANTY

- We strive to offer quality products, and we also try our best to satisfy every customer who orders from us with products or services as needed.
- We provide 30 days warranty starting from the time you receive the item. Each customer must provide a record of their orders such as the order number, or item receipt for any items that are out of the warranty period you may also still receive.
- Replacement parts by purchasing them from our company if they are available.
- For return, please check the return policy with the retailer or market place you bought from

Are you having difficulty

With assembly? Missing parts?
Please send an email with your order No.to
hello@hulalahome.com

Appreciate your purchasing from us.
Pop up your life by our furniture piece!