

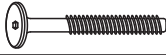









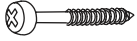





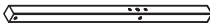
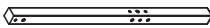

# ASSEMBLY INSTRUCTIONS

## Bed Twin

Avoid using sharp objects such as a knife to cut open packing as you may accidentally damage the item.

### PARTS LIST

ITEM	DESCRIPTION	SKETCH	QUANTITY
HW1	Screw : 1/4x80mm		8x
HW2	Dowel : 10x40mm		16x
HW3	Screw : 4,0x30mm		6x
HW4	Screw : 7,0x80mm		8x
HW5	Screw : 4,0x45mm		6x
HW6	Allen Key		1x
HW7	Elliptical Nut : 1/4x25mm		8x
HW8	Dowel : 8x30mm		34x
A	Upper Grid Crossbar		2x
B	Lower Grid Crossbar		2x
C	Large Grid		7x
D	Small Grid		7x
E	Large Left Foot		1x
F	Large Right Foot		1x
G	Small Left Foot		1x
H	Small Right Foot		1x
I	Side Rails		2x
J	Top Bar		2x
K	Slat		1x

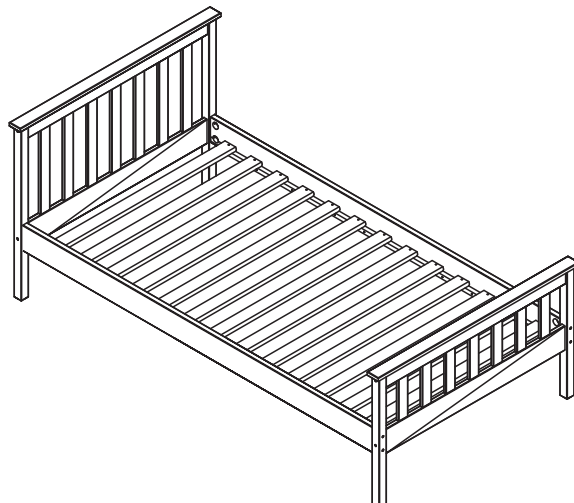

# ASSEMBLY INSTRUCTIONS

Do not fully tighten bolts until assembly is complete.

## Step 1

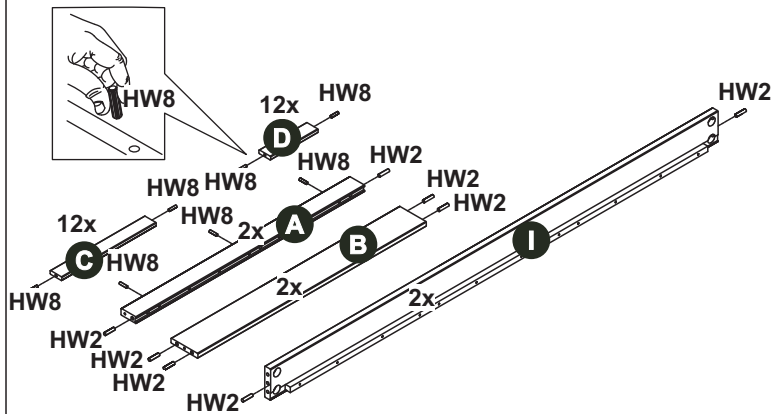

Step 1: Insert the dowels in parts A, B, C, D and I

## Step 2

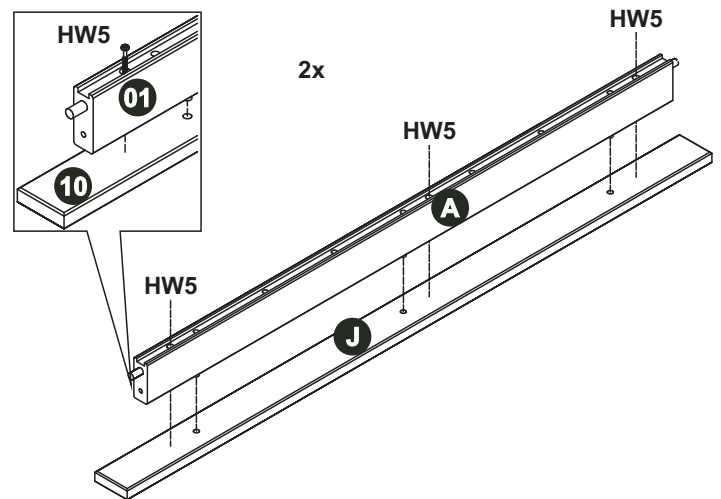

Step 2: Join part A and J with HW5 screw

## Step 3

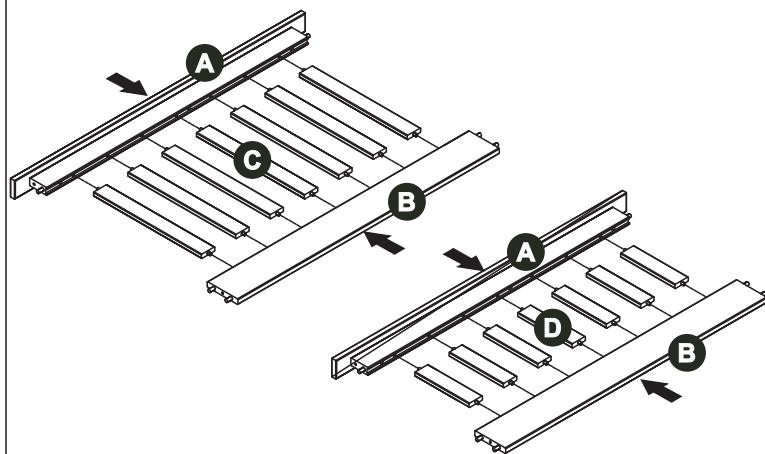

Step 3: Fit parts A and B, on the grid C and D

## Step 4

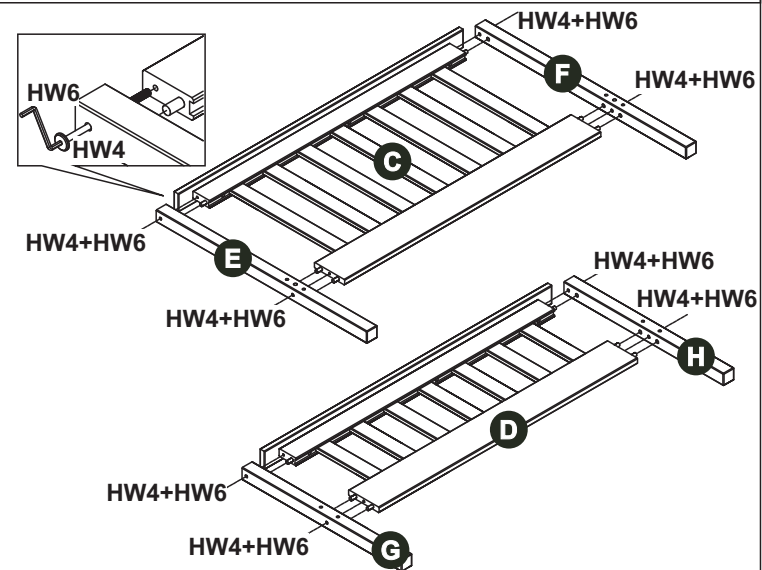

Step 4: Join grid C with feet E + F with HW4 screw and HW6 key  
Join grid D with feet G + H with HW4 screw and HW6 key

## Step 5

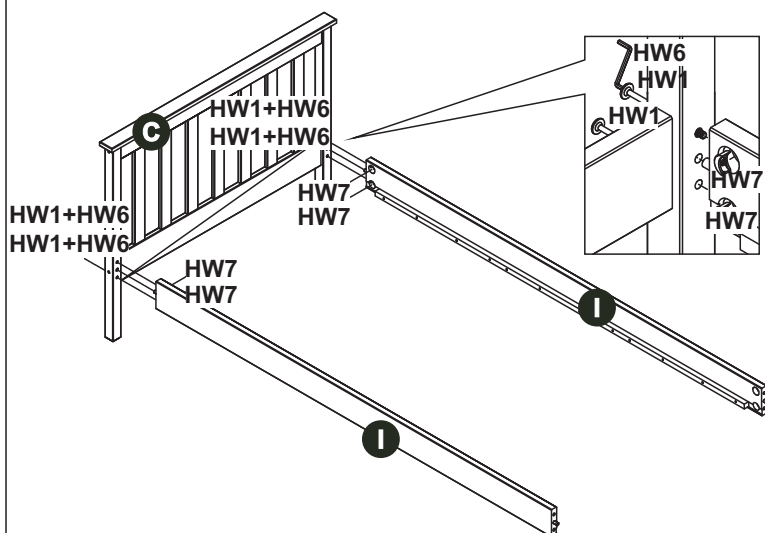

Step 5: Join the mounted grid C with the bars I, use screw HW1 with key HW6 and nut HW7

## Step 6

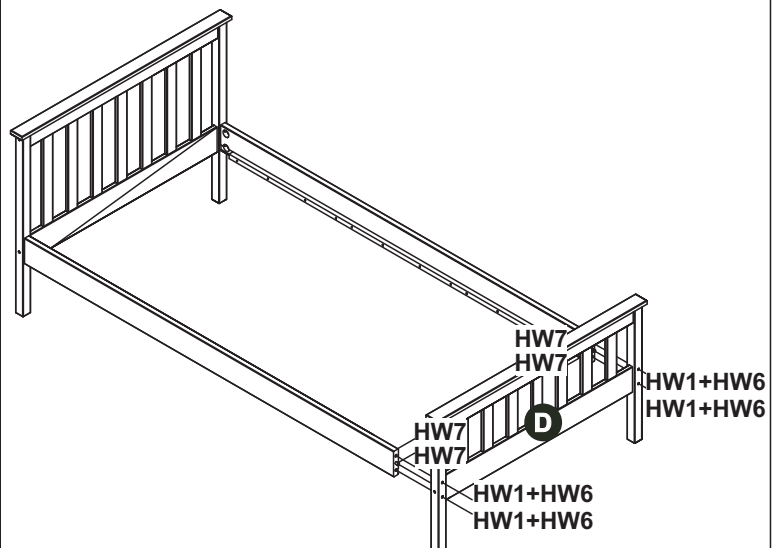

Step 6: Join the mounted grid D with the bars I, use screw HW1 with key HW6 and nut HW7

# ASSEMBLY INSTRUCTIONS

Do not fully tighten bolts until assembly is complete.

## Step 7

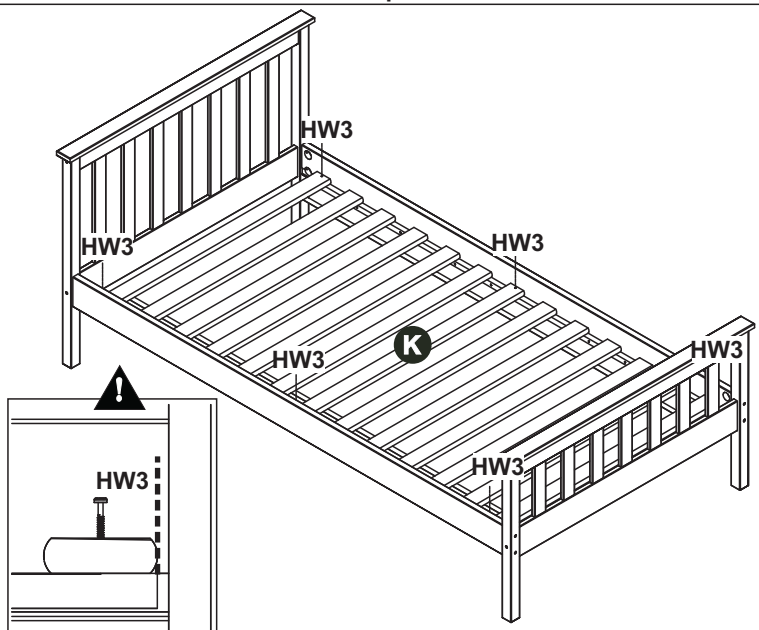

Step 7: Fit the platforms K and fix with screws HW3

**CLEANING INSTRUCTIONS:** Clean with Soft cloth, brush, or lightly vacuum.

### ADULT ASSEMBLY REQUIRED

If you are missing any parts or have any questions regarding assembly, do not return this item to the retailers store. Please call our toll-free, customer service number and have this assembly manual open to the parts list ready to provide the model name, number and part name or number.



**WARNING:** This product may contain small components, please ensure they are kept away from small children.