



**INSTRUCTIONS D'ASSEMBLAGE  
ASSEMBLY INSTRUCTIONS**

---

**TABLE D'APPOINT -  
BLANC LUSTRE ET METAL CHROME**



**ACCENT TABLE -  
GLOSSY WHITE WITH CHROME METAL**



**POUR DE L'ASSISTANCE OU POUR COMMANDER  
DES PIÈCES CONTACTEZ NOTRE DÉPARTEMENT  
DE SERVICE À LA CLIENTÈLE.**

**FOR ASSISTANCE OR TO ORDER PARTS  
CONTACT OUR CUSTOMER SERVICE DEPARTMENT**

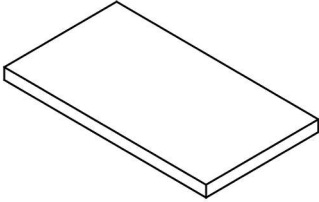
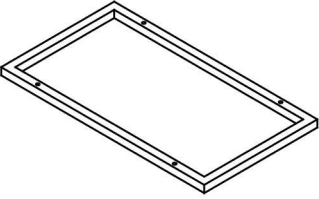
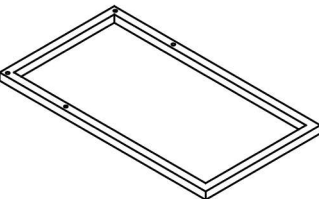
**LISTE DES PIÈCES**  
**PARTS LIST**

PIÈCE / PART #	IMAGE	DESCRIPTION	QTY / QTÉ
<b>1</b>		<b>TABLE TOP SURFACE DE TABLE</b>	<b>1</b>
<b>2</b>		<b>TOP FRAME CADRE DE SURFACE</b>	<b>1</b>
<b>3</b>		<b>BOTTOM FRAME CADRE DU BAS</b>	<b>1</b>
<b>4</b>		<b>FRONT FACING LEFT LEG PATTE AVANT GAUCHE</b>	<b>1</b>
<b>5</b>		<b>FRONT FACING RIGHT LEG PATTE AVANT DROITE</b>	<b>1</b>

**LISTE DES PIÈCES DE MONTAGE**  
**HARDWARE LIST**

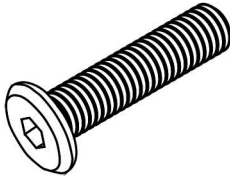
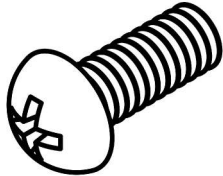
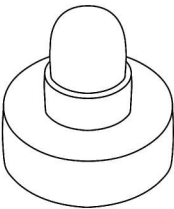
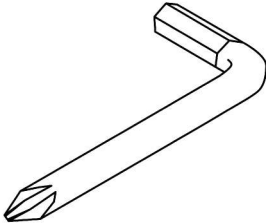
PIÈCE / PART #	IMAGE	DESCRIPTION	QTY / QTÉ
<b>A</b>		ASSEMBLING SCREW - Ø3/8" X 1 1/4" VIS D'ASSEMBLAGE - Ø3/8" X 1 1/4"	4
<b>B</b>		ASSEMBLING BOLT - Ø1/4" X 7/8" BOULON D'ASSEMBLAGE - Ø1/4" X 7/8"	4
<b>C</b>		ASSEMBLING BOLT - Ø1/8" X 1/2" BOULON D'ASSEMBLAGE - Ø1/8" X 1/2"	4
<b>D</b>		FLOOR PROTECTOR - Ø1/4" PROTECTEUR DE PLANCHER - Ø1/4"	4
<b>E</b>		HEX KEY CLÉ HEXAGONALE	1

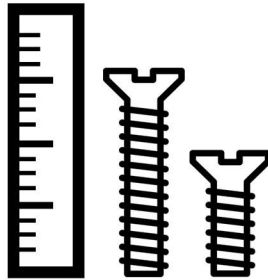

OUTIL DE VÉRIFICATION DE DIMENSIONS DES PIÈCES  
HARDWARE DIMENSIONS VERIFICATION TOOL

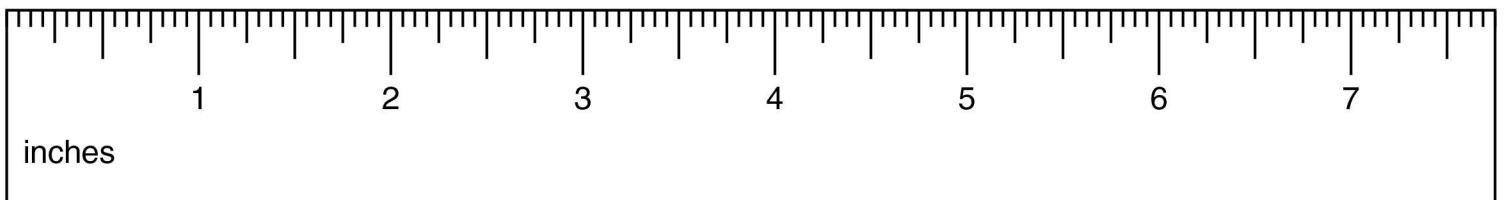

ÉTAPE / STEP 1

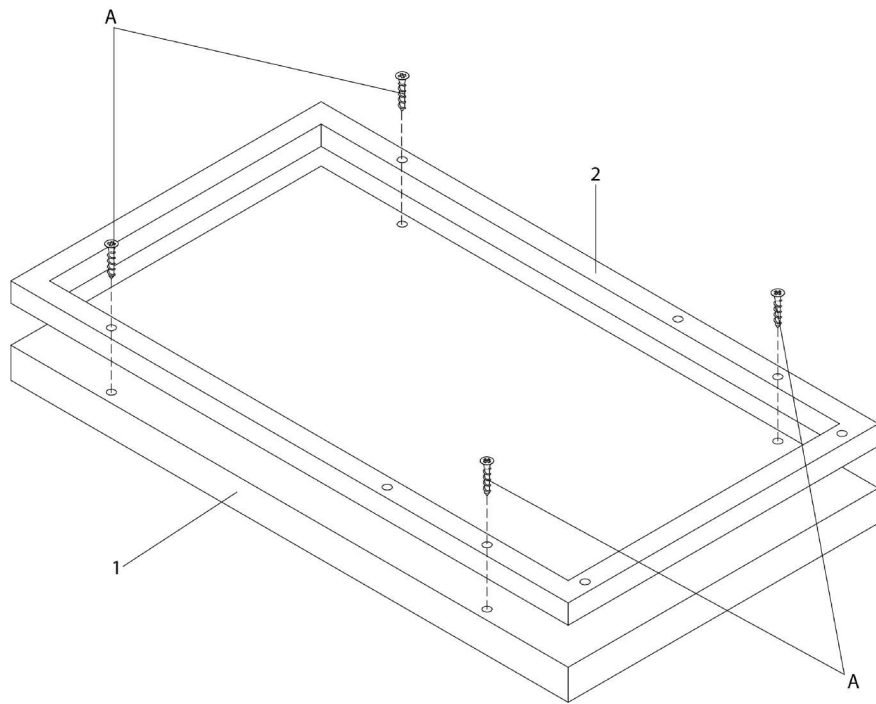

ÉTAPE / STEP 2

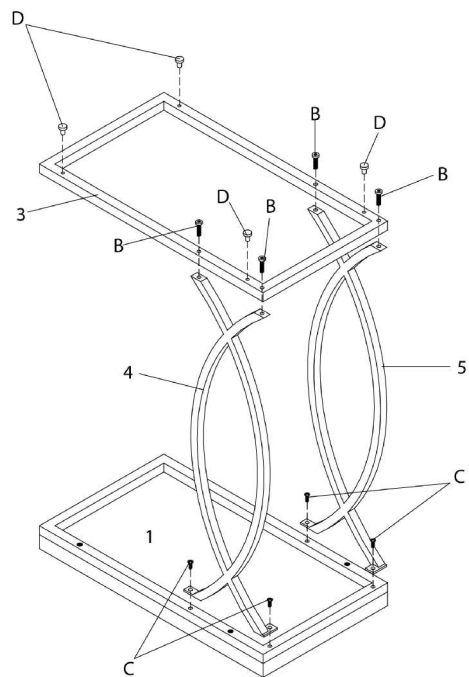

ÉTAPE / STEP 3

