



ASSEMBLY INSTRUCTION FOR ACME FURNITURE





MODEL #27973

Thank you for purchasing this quality product. Be sure to check all packing material carefully for small parts which may have loose inside the carton during shipment. Separate, identify and count all parts and metal hardware. Compare with all parts list to be sure all parts are present. If any part(s) are missing or damaged, please contact your local furniture dealer. For efficient and speedy service, please indicate the model number and code letter of part(s) needed.

Do not fully tighten screw until fully assembled



COMPONENT PARTS		
DESCRIPTION	PART NAME	Q'TY (PCS)
(A)	NIGHTSTAND 	1
(B)	BUN FOOT 	2
(C)	METAL LEG 	2

HARDWARE REQUIRED

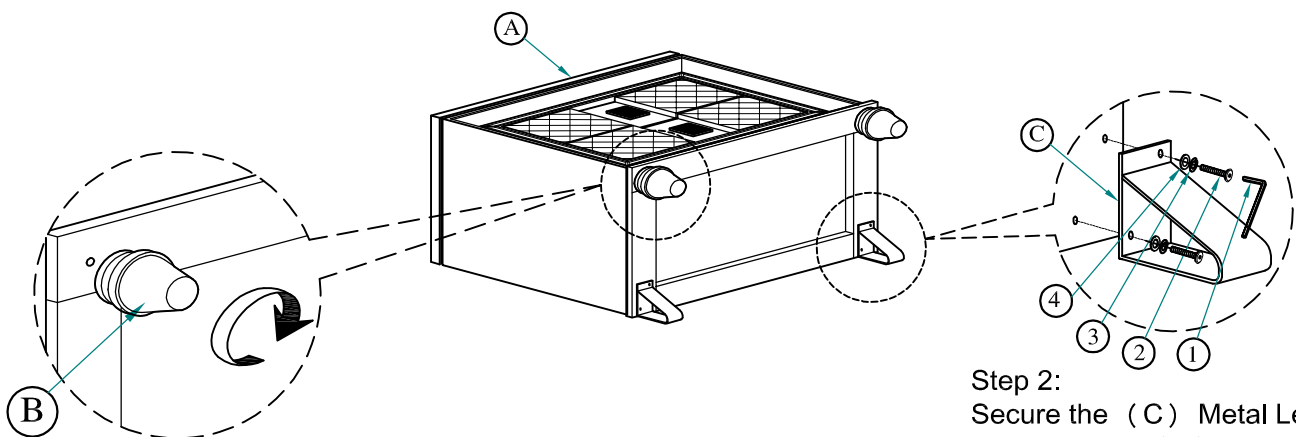
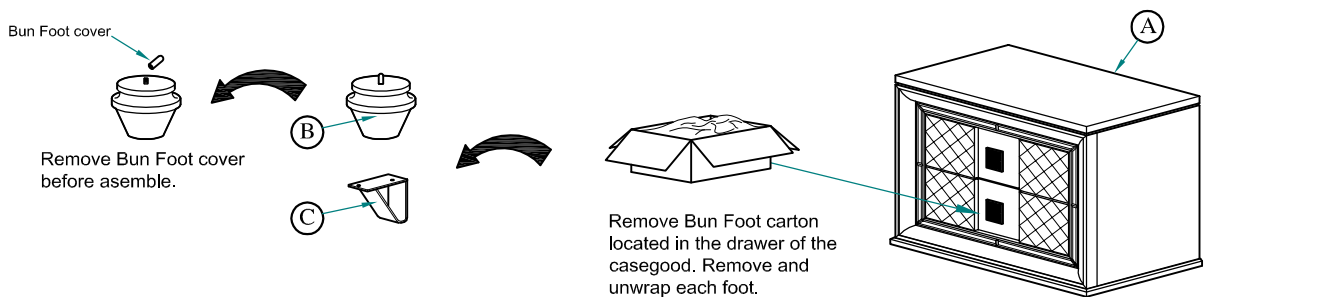
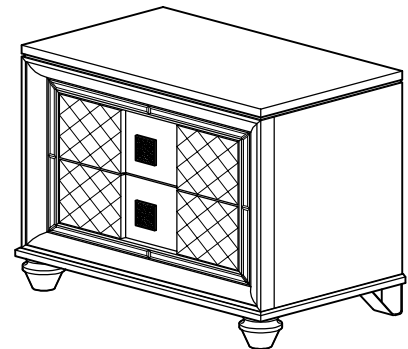
NO	NAME	PART	QTY
1	Allen Key		1pc
2	JCBC - M6 x 20mm		4pcs
3	M6 Spring Washer		4pcs
4	M6 Flat Washer		4pcs



HARDWARE LIST (ANTI TIPPING)

NO	DRAWING	DESCRIPTION	QTY
1		Bracket	2pcs
2		Tie Wrap	1pc
3		Screw (Long)	1pc
4		Screw (Short)	1pc

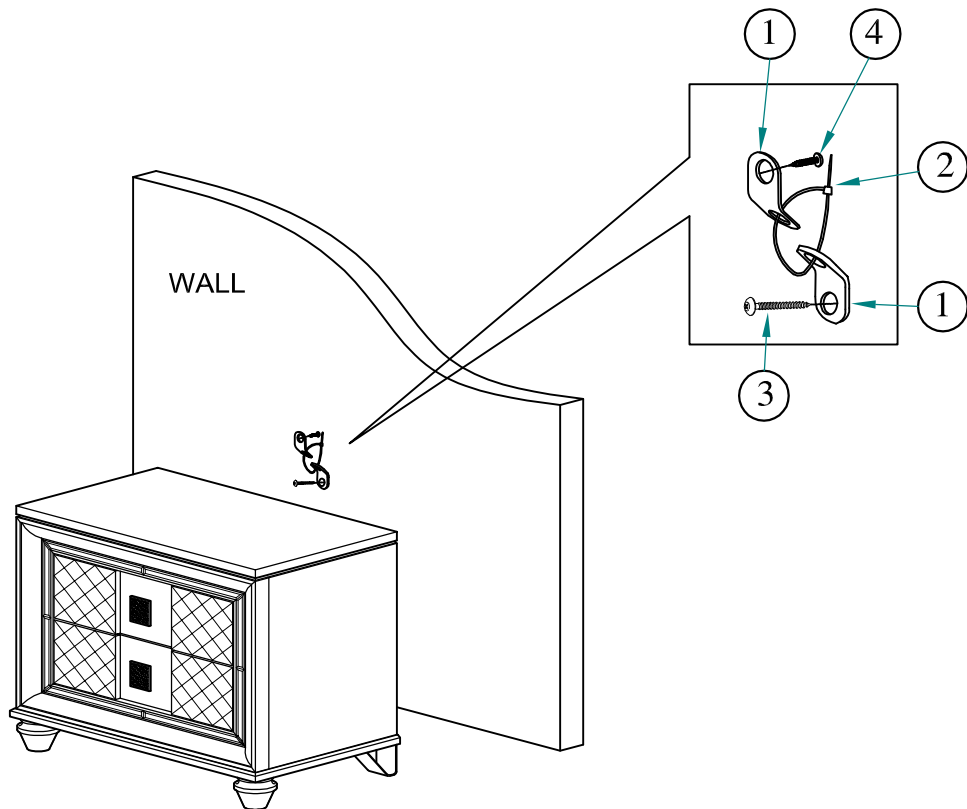

Assembly completed