

# ASSEMBLY AND INSTALLATION INSTRUCTIONS

**WARNING: TO AVOID RISK OF ELECTRICAL SHOCK, BE SURE TO SHUT OFF POWER WHILE INSTALLING OR SERVICING THIS FIXTURE.**

## NOTES:

1. Before installing, consult local electrical codes for wiring and grounding requirements.
2. Read and save these instructions.
3. Always switch off the electricity supply and allow to cool for 10 minutes before changing the light bulbs.

## 1- LIGHT OUTDOOR WALL SCONCE

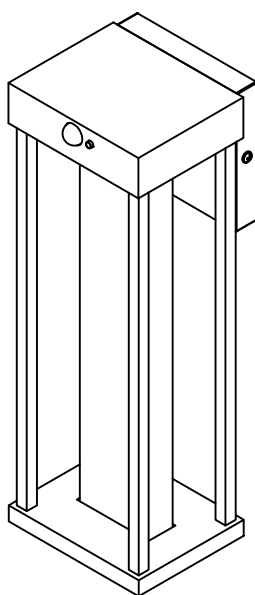

## TOOLS REQUIRED

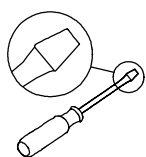

Flathead  
Screwdriver



Phillips  
Screwdriver

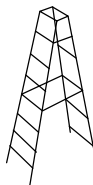

Ladder

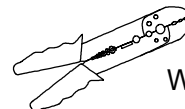

Wire Strippers



Pliers



Electrical  
Tape

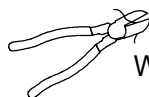

Wire Cutters



Safety Glasses

## PREPARATION

Before beginning assembly of product, make sure all parts are present. Compare parts with package contents list and hardware contents list. If any part is missing or damaged, do not attempt to assemble the product. When the lamp is not installed finish, please don't throw away the package, so as not to leave the parts in the package.

## PART LIST AND HARDWARE LIST

PIECE	DESCRIPTION	QUANTITY
A	Wire Nut	3
B	Mounting Plate	1
C	Outlet Box Screw	2
D	Green Ground Screw	1
E	Rubber Pads	2
F	Mounting Screw	2
G	Fixture Body	1
H	Crystal	1
I	Iron Square Box	1
J	Screw	2

## INSTALLATION

1. Attach the Mounting plate (B) to the Outlet box with outlet box screw (C) then fix it.
2. Take out the crystal (H) and insert it into the square hole at the bottom of the Fixture Body (G) until it reaches the square hole at the top. Cover it with an iron square box (I) and tighten it with screws (J)
3. Attach the supply circuit ground wire (green or bare copper wire) to the the fixture ground wire, black to (black) and white to (white).
4. Use mounting screws (E.F) to connect the fixture body (G) to the mounting plate (B).

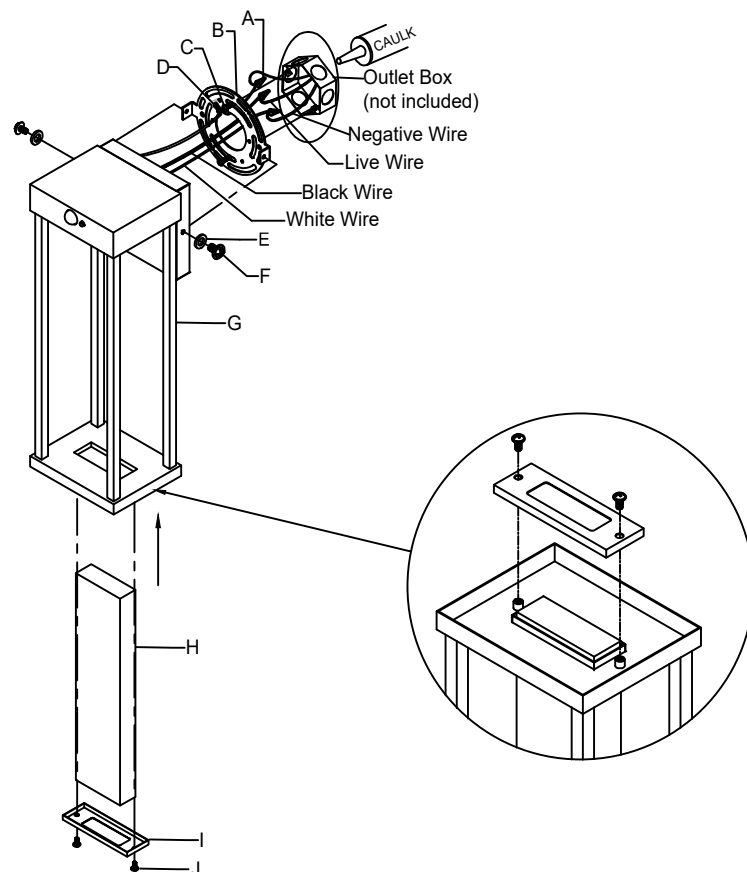

If you have any issues with use this product, please email us. Be sure to include your order number and photos of the issues. This will help us provide you with faster support and solve your problem.

# Function and Operation

## MODES OF OPERATION

Mode	Works at	ON time	Shut off delay time	Explanation
	Day & Night	15 Sec	/	Turn on the power at the main fuse or circuit breaker box, the light will turn on immediately. Wait for about 15 seconds to allow the sensor to warm up, then the light will automatically enter into the Dual-bright test mode or ON/OFF test mode.
	Day & Night	As motion existing	5 Sec	<p><b>Dual-bright test mode:</b> The light will turn on at low-level brightness (Default setting is 40% brightness, low-level brightness can be adjusted from 15~50%, See FIG.1) in the test mode. When motion is detected, the light will turn to high-level brightness (100% brightness), and stay on as long as the motion is continuing. The light will revert to low-level brightness about 5 seconds after motion is no longer detected.</p> <p><b>ON/OFF test mode:</b> The light will turn on at high-level brightness (100% brightness) when motion is detected, and stay on as long as the motion is continuing. The light will turn off in about 5 seconds after motion is no longer detected.</p> <p><b>If you need to switch between Dual-bright test mode and ON/OFF test mode, please press the tact switch on front of the sensor(See FIG.2)</b></p> <p><b>Note: The time of TEST mode is approximately 120 seconds, then light will automatically enter into the Dual-bright mode or ON/OFF mode.</b></p>
	Night only	As motion existing	2 Min.	<p><b>Dual-bright mode:</b> At dusk, the light will turn on at low-level brightness (Default setting is 40% brightness, low-level brightness can be adjusted from 15~50%, See FIG.1). When motion is detected, the light will turn to high-level brightness (100% brightness), and stay on as long as the motion is continuing. The light will revert to low-level brightness about 120 seconds after motion is no longer detected. Until dawn, the lights will turn off in about 30 seconds.</p> <p><b>ON/OFF mode:</b> At dusk, the light will turn on at high-level brightness (100% brightness) when motion is detected, and stay on as long as the motion is continuing. The light will turn off in about 120 seconds after motion is no longer detected.</p> <p><b>If you need to switch between Dual-bright mode and ON/OFF mode, please press the tact switch on front of the sensor, then the motion sensor will enter into ON/OFF test mode or Dual-bright test mode (See FIG.2)</b></p> <p>There is one red LED on motion sensor flashing 1 times when motion is detected.</p>
	Night only	Manual override operate	8Hrs or Turn off at dawn	<p>In "Dual-bright" mode or "ON/OFF" mode, to shift to the manual override mode, turn the wall switch "OFF", and turn it "ON" within 2 seconds. The light will turn on and stay on for approximately 8 hours, or until the Dusk-to-Dawn sensor detects light in the morning. Once the Dusk-to-Dawn sensor detects light for more than 30 seconds, the manual override mode will automatically go back to "Dual-bright" mode or "ON/OFF" mode. (See FIG.3)</p> <p>Note:</p> <ol style="list-style-type: none"> <li>To make sure the above functions operate properly, always keep the wall switch in the "ON" position (including the daytime).</li> <li>Turn the wall switch "OFF", wait over 10 seconds and then switch it "ON" again, the light will revert to warm-up period again.</li> </ol>

FIG.1 Low level brightness dimming Operating Diagram



Note: Press tact switch continuously for more than 2 seconds except Warm up mode, the PIR motion sensor will enter the low-level brightness dimming function. Release tact switch immediately after adjusting to the desired brightness, and the sensor will remember this brightness to work in **Dual-bright Test mode**.

The following problems can be solved by low-level brightness dimming:

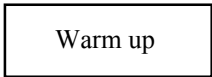
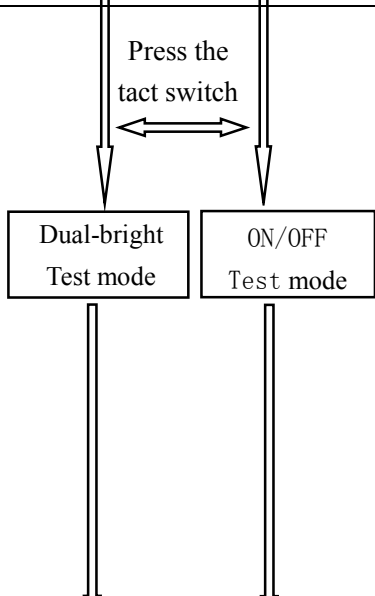
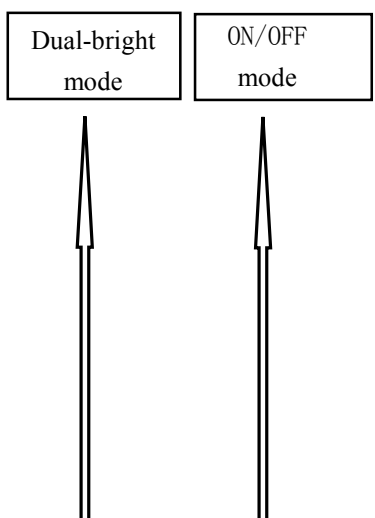
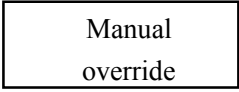
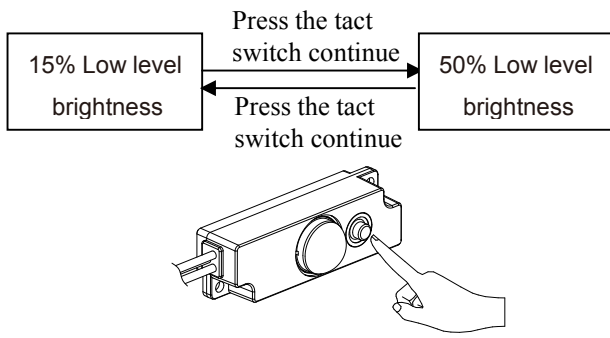
1. You can reduce the low-level brightness to increase the difference from full brightness.
2. You can avoid light source flickers points of low-level brightness of a small number of bulbs by dimming

FIG.2 Mode Operating Diagram

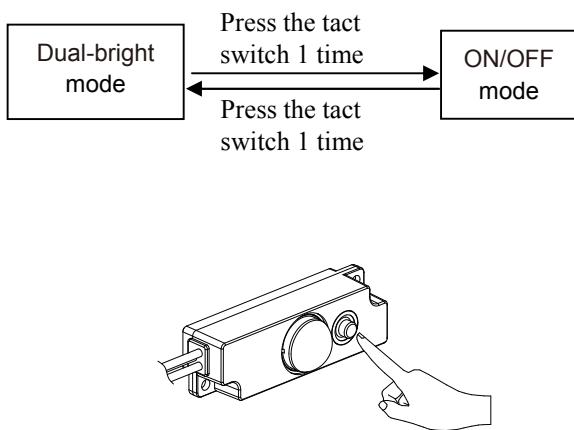
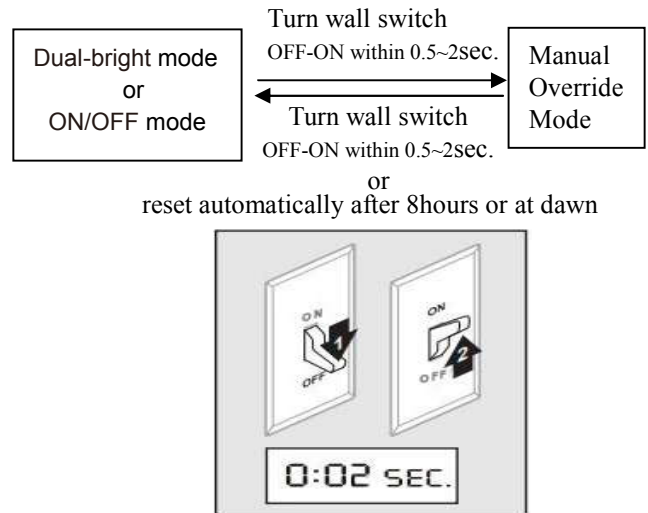

FIG.3 Manual Override Operating Diagram



**NOTE:**

1. The sensitivity of the motion sensor will increase as the environmental temperature gets cooler. For best performance, gently clean the lens with a soft cloth every 1 or 2 months to assure maximum sensitivity.
2. For best performance, install fixture at 6~8 feet above the ground. At such a height, the lantern will provide a detection distance of up to 25 feet at 77 degrees Fahrenheit.(See Fig.4)
3. The sensor detects across a detection range of 120 degrees.(See Fig.5)
4. The sensor will be more sensitive to motion across its detection path than motion directly towards it. (See Fig.6)
5. To reduce possible nuisances, do not mount the fixture near a heat source like an air conditioner, vent or furnace exhaust, or in a direction facing any reflecting object or other light source.

FIG. 4

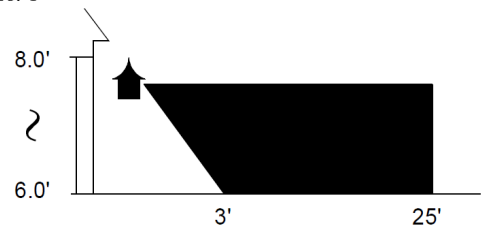

FIG. 5

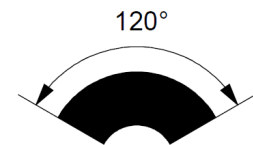
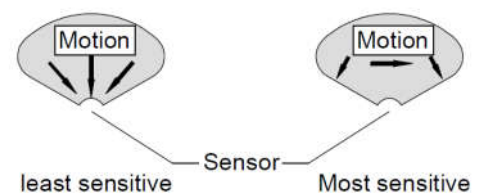

FIG. 6



# Troubleshooting

SYMPTOM	Possible Cause	Solution
The light doesn't work in Test Mode	Wall switch or circuit breaker is off The wiring is mistake	Turn on a switch or circuit breaker. Check wire connections.
In Dual-bright mode or ON/OFF mode , the lighting fixture does not turn on when there is motion	Wall switch or circuit breaker is off	Turn on a switch or circuit breaker.
	Light bulb may be dead.	Test the light bulb in a known working light fixture
	Light bulb is loose.	Tighten the light bulb in the socket.
	Incorrect or loose wire connections.	Check wire connections.
	Too much sunlight is shining into the Dusk-to-Dawn sensor in the early evening.	Relocate fixture away from a western facing wall.
	Too much light is shining onto the Dusk-to-Dawn sensor due to another light source, such as a street lamp or other light fixture.	Eliminate or turn off other light source, block other light source from shining onto Dusk-to-Dawn sensor, or relocate fixture.
In Dual-bright mode or ON/OFF mode , the lighting fixture stays on at 100% brightness continuously.	False triggering caused by a heat source, such as street or sidewalk traffic, a heater or dryer vent, or air conditioning vent, or heated swimming pool.	Eliminate heat source or relocate fixture
The lighting fixture comes on at 100% brightness for no apparent reason	False triggering caused by a heat source, such as street or sidewalk traffic, a heater or dryer vent, or air conditioning vent, or heated swimming pool.	Eliminate heat source or relocate fixture
The lighting fixture comes on during the daytime or too early in the evening	The fixture may be installed in a shaded area, such as under a porch or eave, preventing daylight from shining onto the Dusk-to-Dawn sensor.	Relocate the fixture
The LED bulb or fluorescent bulb flickers when the lighting fixture is dimmed down to the stand-by dimming level.	Non-dimmable LED bulb or fluorescent bulb is used on the lighting fixture.	Replace dimmable LED bulb or fluorescent bulb, or incandescent bulb
	A small number dimmable LED bulbs or fluorescent bulbs do not match.	Press the tact switch continuously to change the low-level brightness to avoid the flickers point.
In Dual-bright mode, the standby brightness is close to the full brightness.	A small number dimmable LED bulbs or fluorescent bulbs do not match.	Press the tact switch continuously to reduce the low-level brightness to increase the difference from full brightness.
In Manual override, the light stays on after dawn	The ambient light level is too low	Relocate the fixture