

Assembly Instruction

CAUTION: Read instruction carefully and turn electricity off at main circuit breaker panel before beginning installation.

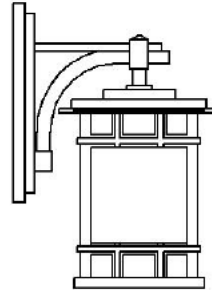

Care and Cleaning

To clean the outside of the fixture, use a dry or slightly dampened clean cloth (use clean water, never a











To clear the inside of the fixture, first disconnect power to the fixture by turning off the circuit breaker or

by removing the fuse at the fuse box. Next, use a dry or slightly dampened clean cloth (use

Do not use any cleaners with chemical, solvents or harsh abrasives. Use Only a dry soft cloth to dust or

Estimated Assembly Time: 20 minutes

Part List and Hardware List

PIECE	DESCRIPTION	PICTURE	QUANTITY	PIECE	DESCRIPTION	PICTURE	QUANTITY
A	mounting bracket		1X	G	mounting screw		2X
B	machine screw		2X	H	ground screw		1X
C	backplate		1X	J	bulb		1X
D	washer		4X	k	Frame		1X
E	Cap Nut		2X	M	Studs		2X
F	wire connector		3X				

Installation

Step 1

Loose the Studs(M) to remove the polyfoam from the Frame(K)

Step 2

Install the mounting bracket(A) to the junction box with machine screw (B)

Step 3 Wire connection

Make wire connections, with wire connectors(F), following the reference chart listed below.

Connect,Hot,Black or Red outlet Supply Wire to:	Connect,Neutral,White Outlet Supply Wire to:
Black	White
*Parallel Cord(round&smooth)	*Parallel Cord(square&ridged)
Clear,Brown,Gold or Black without Tracer(colored stripes)	Clear,Brwn,Gold or Black without Tracer(colored stripes)
Insulated Wire(not green)with copper metal conductor	Insulated Wire(not green)with Silver metal conductor

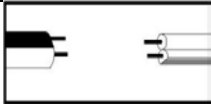

*Note: When parallel wire(SPTI&SPTII)is used. The neutral wire is square shaped and ridged and the hot wire will be round in shape and smooth.(See illustration on left)



Grounding Instructions:

- For installation in the United States: Wrap ground wire from outlet box around green ground screw on mounting bracket, no less than 2" from wire end. Tighten ground screw. If fixture is supplied with a ground wire, connect to outlet ground wire with a wire connector.
- For installation in Canada: If fixture is supplied with ground wire, wrap ground wire around green grounding screw on mounting bracket. Tighten ground screw.

Step 4

Attach the backplate(C) to the junction box and fix it by turning the washer(D) and screw (E) clockwise

Step 5

Insert the bulbs (J) into the socket (I).

Step 6

connect Frame(K) to the Top Hood(L)by using 2pcs Studs(M) and washer(D) .

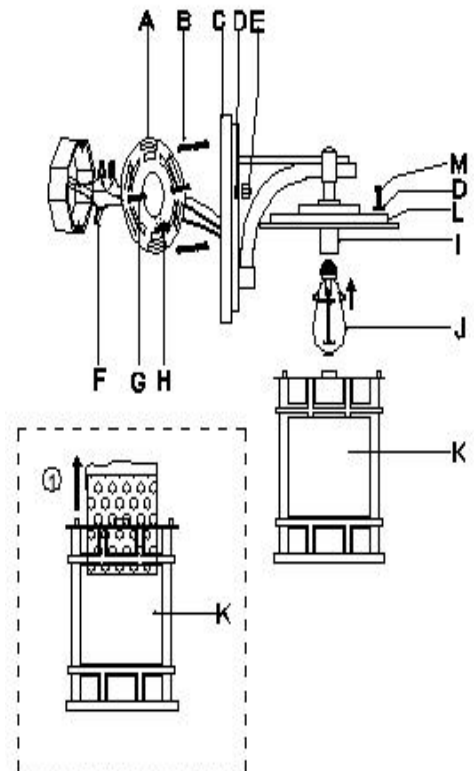

PLEASE USE TYPE"C" BULB MAX 40-WATT OR CFL BULB MAX 13-WATT OR LED BULB MAX 9-WATT THERE IS 1PC ST58 4 WATT LED BULB IN THE BOX

ENJOY YOUR LAMP