

ASSEMBLY INSTRUCTIONS



Wine Cabinet

ASSEMBLY INSTRUCTIONS

ASSEMBLY TIPS:

1. Remove hardware from box and sort by size.
2. Please check to see that all hardware and parts are present prior to start of assembly.
3. Please follow attached instructions in the same sequence as numbered to assure fast & easy assembly.



WARNING!

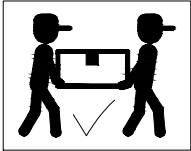

1. Don't attempt to repair or modify parts that are broken or defective. Please contact the store immediately.
2. This product is for home use only and not intended for commercial establishments.





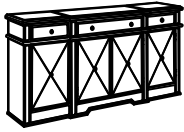

ASSEMBLY TIME

30 MINUTES

PARTS IDENTIFICATION

A	CABINET		1PC
B	LEG		6PCS

Z HARDWARE IDENTIFICATION

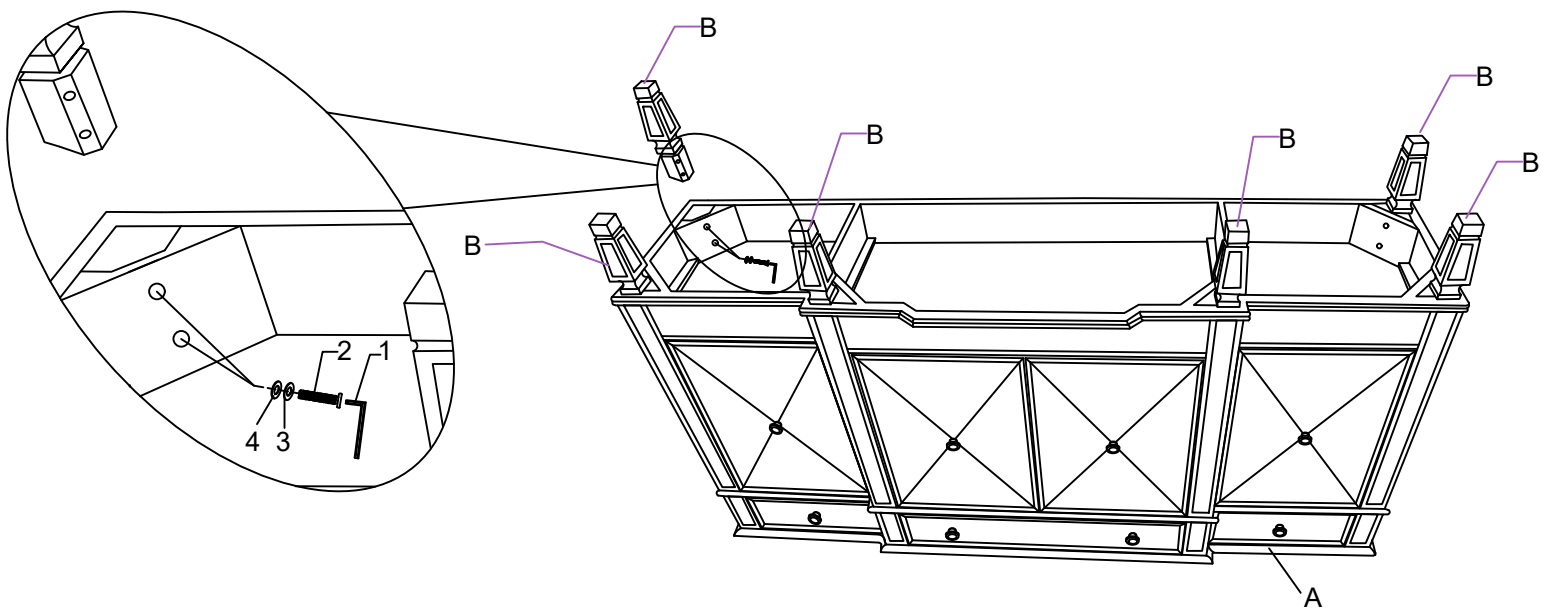

1	ALLEN WRENCH		Ø5mm	1PC
2	BOLT		Ø8*40mm	12PCS
3	LOCK WASHER		Ø8mm	12PCS
4	FLAT WASHER		Ø8mm	12PCS

STEP 1

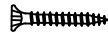

Please install the Anti tipping hardware as shown in the drawing - this can help to prevent any tipping issues.

Z HARDWARE PACKAGE

NO.	DESCRIPTION	FIGURE	SIZE	Q'TY
1	PLUG			2PCS
2	LARGE SCREW		Ø8x2"	1PC
3	TIGHTWIRE			1PC
4	SHORT SCREW		Ø8x3/4"	1PC

ATTENTION: Anti tipping safeguard

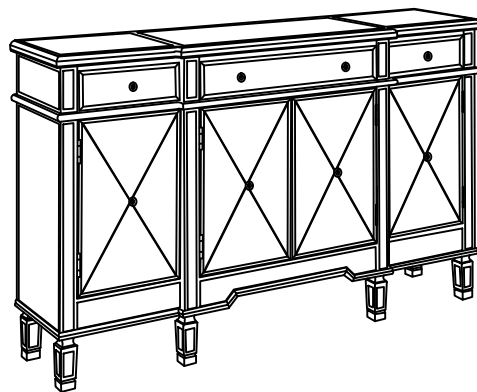
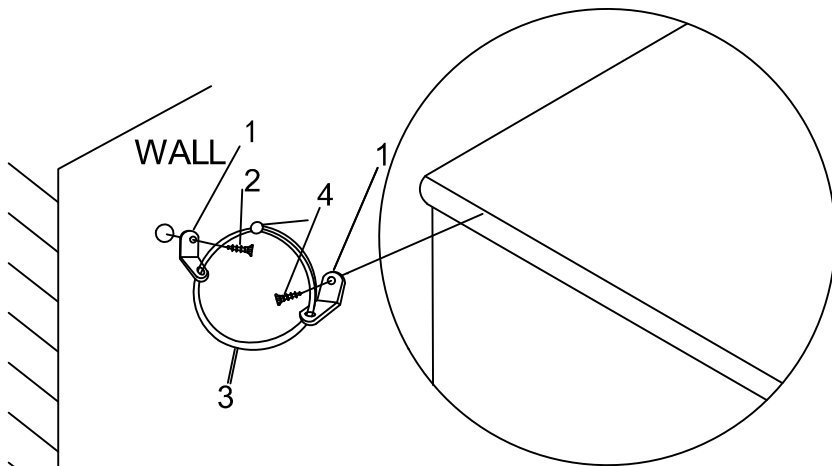

FURNITURE TIPPING RESTRAINT

WARNING

Injury may result from tipping furniture
 This restraint is not a substitute for proper adult supervision
 This restraint may provide protection against tipping furniture.
 Do not allow children to climb on furniture.
 Failure to detach this restraint before moving furniture may
 result in injury and damage

