

INTERIOR DOOR ASSEMBLY GUIDE

5P-Slab Door Installation Instruction

5P-Slab Door Assembly Detail		
A	Side Stile	2
T1	Top Rail	1
T2	Middle Rail	2
T3	Middle Rail	2
T4	Bottom Rail	1
P	MDF Panel	5
D	3.93" Carriage Bolts	12
E	Plastic CAP	12
F	Wood Plug	8
G	Hex Key	1

The diagram illustrates the assembly of the 5P-Slab Door. It shows a central vertical stack of components: a Top Rail (T1), followed by five MDF Panels (P), and four rails (T2, T3, T3, T2) alternating with the panels. Two Side Stiles (A) are attached to the left and right sides of the assembly. Hardware components are shown to the right: D (3.93" Carriage Bolt), E (Plastic CAP), F (Wood Plug), and G (Hex Key).

TIPS: For assistance with installation, please contact our customer support team. We offer several sizes of boards, Let's look at them from different perspectives.

Details of accessories

Stile Side Views

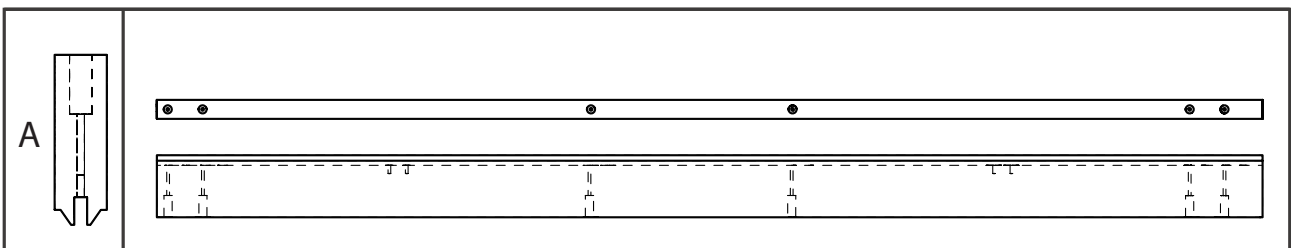

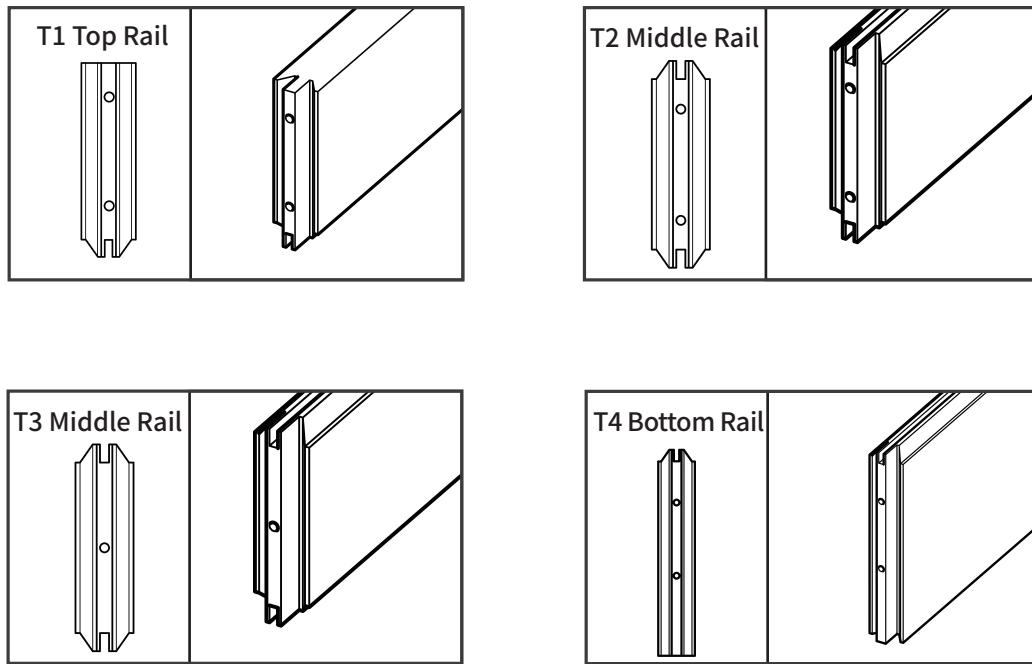

Instructions

Step-1

Place the Left Side Stile (**A**) on a smooth and clean surface with the groove facing to the right. Get Top Rail (**T1**), Middle Rail (**T3**), and Bottom Rail (**T4**), insert their tongues into the grooves of (**A**), and align the pre-drilled holes of (**A**) and pre-installed anchors of (**T1/T3/T4**). Get 3.93" Carriage Bolts (**D**), insert into the outside holes of (**A**), use Hey Key (**G**) to fasten bolts (**D**) to the pre-installed anchors in (**T1/T3/T4**).

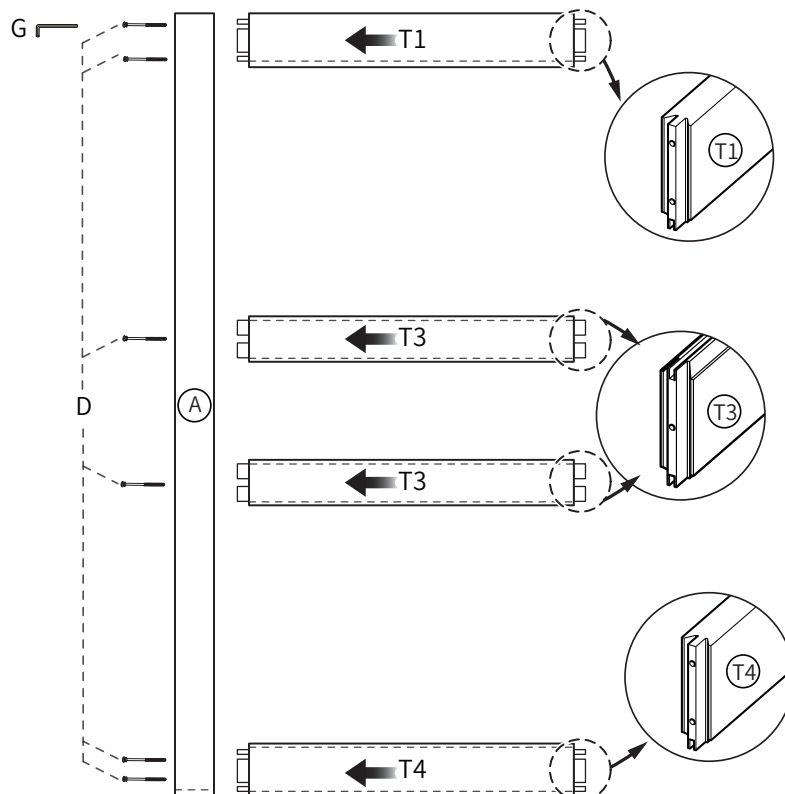

Step-2

Get Middle Rail (**T2**), insert Wood Plug (**F**) into the 8 pre-drilled holes on each **T2**, and then insert the left end into the inside pre-drilled hole on (**A**).

The pre-drilled holes' location is as indicated in the instruction.

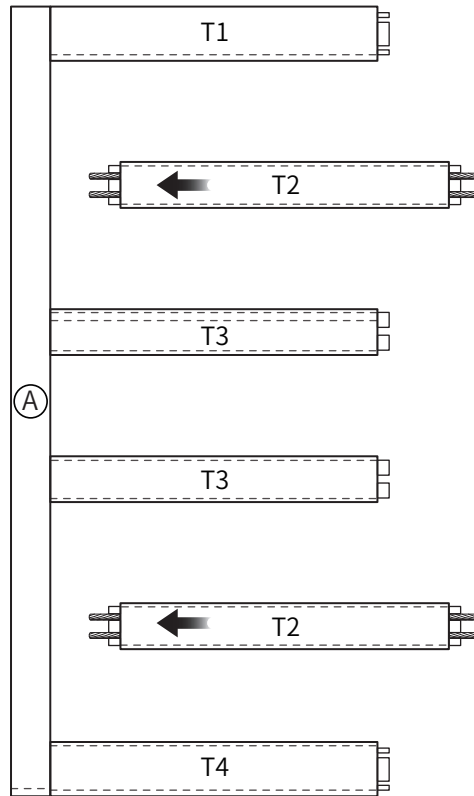

Step-3

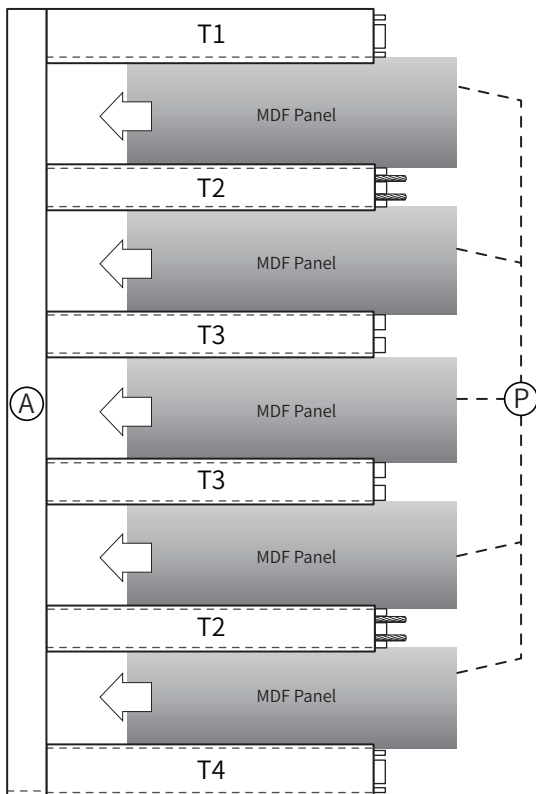

Get Mdf Panel (**P**), slide it along the grooves between T, and make sure to insert it into the groove of (**A**).

Please wear gloves to prevent cuts on your hands.

Step-4

Get Right Side Stile (**A**), make the groove side cover all tongues and the edge of the slats.

Then get 3.93" Carriage Bolts (**D**), insert to the holes on the outside of A, and use Hey Key.

(**G**) to fasten bolts (**D**) to the pre-installed anchors in (**T1/T3/T4**).

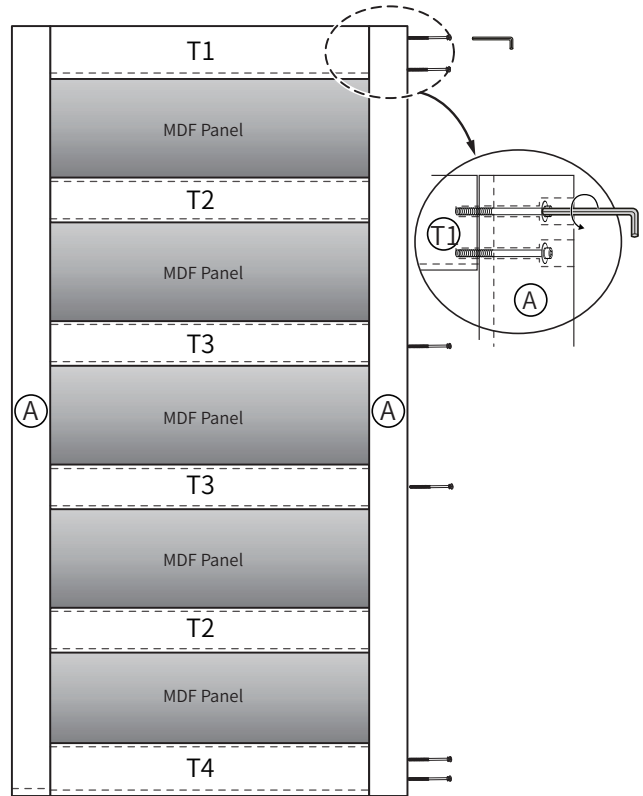

Step-5

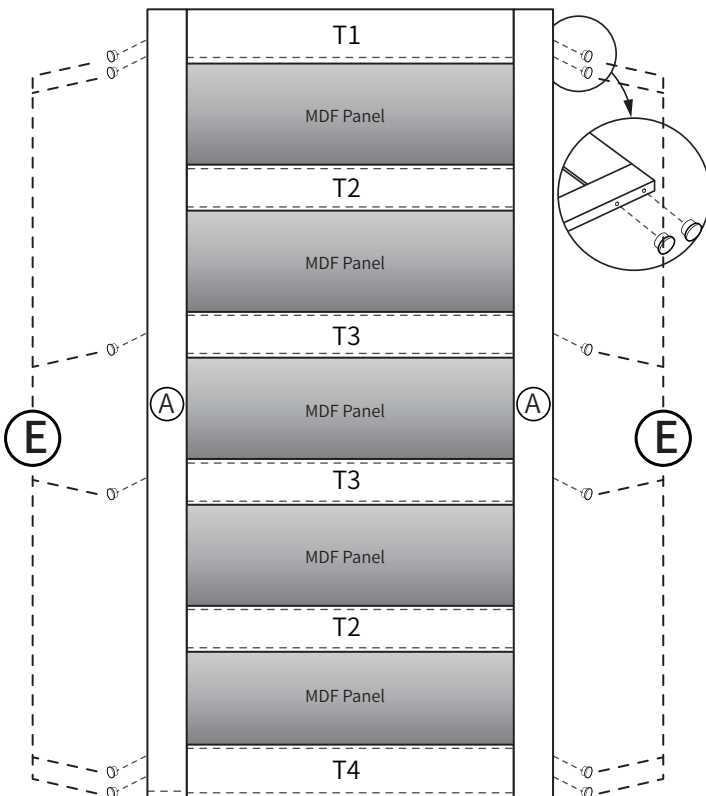

Get Plastic CAP (**E**), insert it into all the holes on the outside of Side Stile A, then the door. installation is complete.

WARNING

Failure to wear proper safety gear (i.e., eye protection) may result injury or death. Always wear proper safety gear before using any power tools.

Improper operation of power tools may result in loss of control, serious injury or death. Always ensure you have complete control of the power tool and the work area is hazard-free before operating any power tools.

Lack of secure clamping of the door may result in unexpected movement of the door, loss of power tool control and serious injury or death. Always securely clamp the door in place before cutting or drilling the door.

Lack of, or improperly installed anti-jump pad may result in the door coming off the track and cause serious injury or death. Installation of anti-jump pads are required for safe operation of this hardware. Installed properly, these anti-jump pads will keep the door securely attached to the track.

CAUTION

Mishandling of heavy objects (i.e., doors) may cause a los of balance and serious injury. Always be sure to have a secure hold on the object and are balanced before moving the object. Always wear safety shoes when lifting heavy objects.

Getting body parts (i.e., hair, fingers) caught in moving parts may cause pinching and serious injury. Do not put fingers in parts that may move and always remove or contain anything on your body that may become entangled with a moving part.

Closing sliding doors with your hand on the end of the door may result in your hand, or fingers, getting caught between the door and other solid objects (i.e., another door, molding) causing serious injury. Always use the door handle to close doors.

Usage Statement:

Use of excessive force when opening, and closing, the door(s) may result in damage to the hardware. Always hold the handle and gently open and close the door(s) .

Warranty Statement:

1 year straight unconditional warranty service enables every single hardware's durability coverage during its life time.

Warranty

Our products come with a 1 year warranty from the date of purchase. In any event that the product arrives damaged or missing parts, we are more than happy to provide you with replacement part(s). Register your product on our website to enjoy extended warranty!!

Easy Return

We work hard to make sure order arrives safe and secure, but rest assured we will take care of it if it is not up to standard. If you need replacement parts, Contact us we will send you replacements with no hassle.



Contact Us

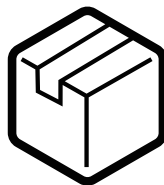

Replacement

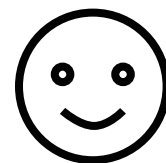

You

You don't have to worry about re-packaging / schedule pick-up.