

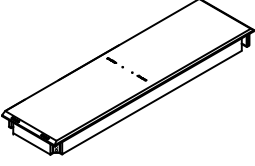











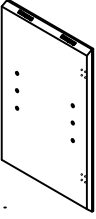
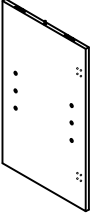
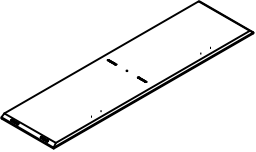
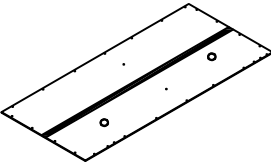
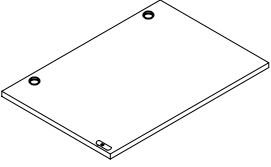
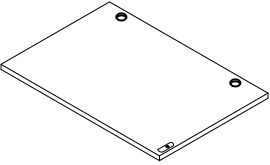
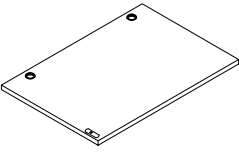
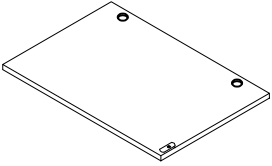
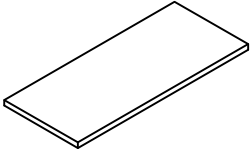
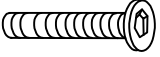

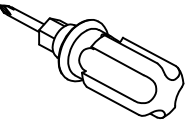
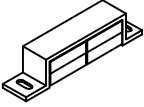

Thank you for purchasing , Please read the instructions and warnings carefully before use, to ensure safe and satisfactory operation of this product. We are committed to making great products possible. From our in-house Design Team, to our Buyers, we work together to bring great designs to life. Our expert Product Technologists work collaboratively with our buyers and suppliers to assure the legality, safety and quality of the product we sell. We are all committed to designing and developing products to the highest industry standards. We hope you are happy with your product and welcome any feedback or comments you may have.

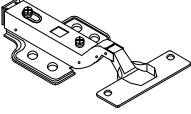
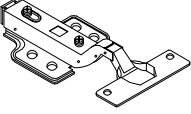

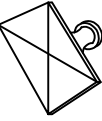
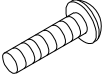
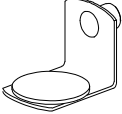
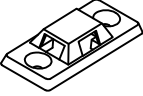
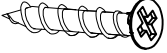
PARTS LIST

| | | | | |
|--|---|---|--|---|
| <p>A x1</p>  <p>Bottom Panel</p> | <p>B x4</p>  <p>Leg</p> | <p>C x1</p>  <p>Middle Leg</p> | <p>D x1</p>  <p>Left Side Panel</p> | <p>E x1</p>  <p>Right Side Panel</p> |
| <p>F x1</p>  <p>Middle Vertical Panel</p> | <p>G x1</p>  <p>Top Panel</p> | <p>H x1</p>  <p>Back Panel</p> | <p>I x1</p>  <p>Left Door</p> | <p>J x1</p>  <p>Right Door</p> |
| <p>K x1</p>  <p>Middle Left Door</p> | <p>L x1</p>  <p>Middle Right Door</p> | <p>M x2</p>  <p>Shelf Panel</p> | | |

HARDWARE LIST

| | | | | | | | | | |
|---|-----|--|-----|---|----|--|----|--|-----|
| 1 | x8 | 2 | x8 | 3 | x8 | 4 | x1 | 5 | x1 |
|  | |  | |  | |  | |  | |
| Allen Bolt Ø1/4"x 2" | | Spring Washer | | Flat Washer | | Allen Wrench | | Screw driver | |
| 6 | x 2 | 7 | x28 | 8 | x4 | 9 | x4 | 10 | x48 |
|  | |  | |  | |  | |  | |
| Magnet | | Screw Ø3*15MM | | Hinge | | Hinge | | Screw Ø3*15MM | |
| 11 | x4 | 12 | x4 | 13 | x8 | 14 | x4 | 15 | x4 |
|  | |  | |  | |  | |  | |
| Knob | | Knob Bolt Ø5/32" x 3/4" | | Shelf Support | | Bracket | | Screw Ø3* 20MM | |
| 16 | x4 | 17 | x4 | 18 | x2 | | | | |
|  | |  | |  | | | | | |
| Anchor | | Screw Ø4* 38MM | | Tie | | | | | |





SPARE

| | | | |
|---|----|---|----|
| 7 | x2 | 10 | x2 |
|  | |  | |
| Screw Ø3*15MM | | Screw Ø3*15MM | |

Be sure to check all packing material carefully for small parts, which may have come loose inside the carton during shipment.

ASSEMBLY INSTRUCTION

STEP 1

| | | |
|---|---|----|
| 1 |  | x8 |
| 2 |  | x8 |
| 3 |  | x8 |
| 4 |  | x1 |

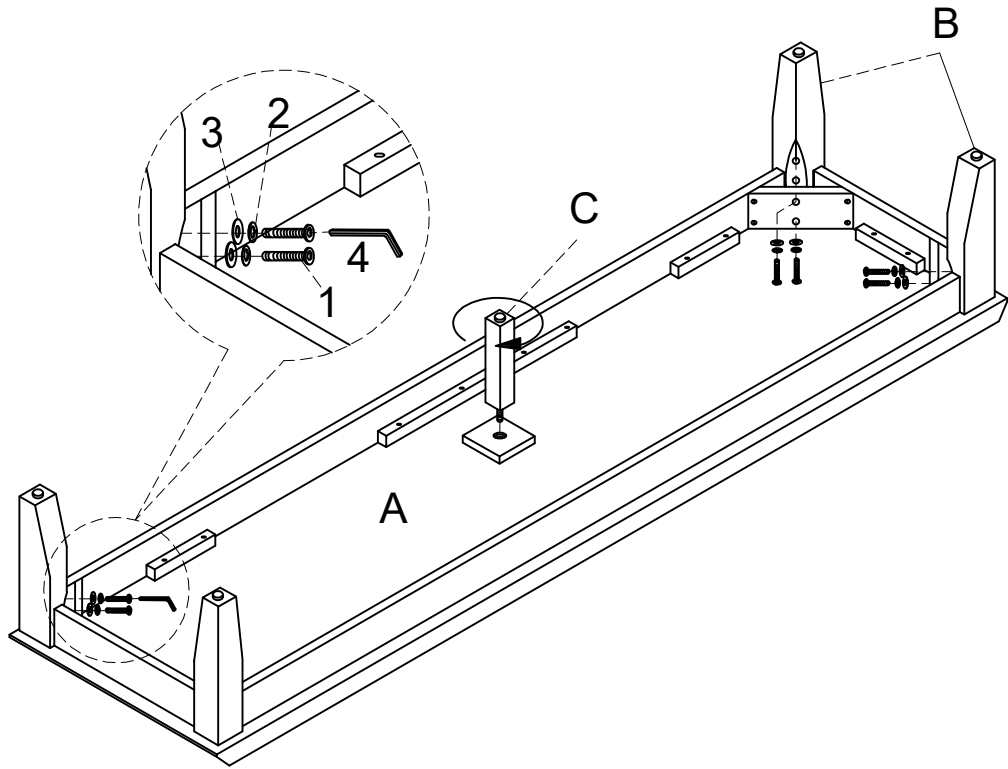

Attach leg(B/C) to bottom panel(A) with bolt(1) and flat washer(3) and spring washer(2), tight it with Allen wrench(4).

STEP 2

| | | |
|---|---|----|
| 4 |  | x1 |
|---|---|----|

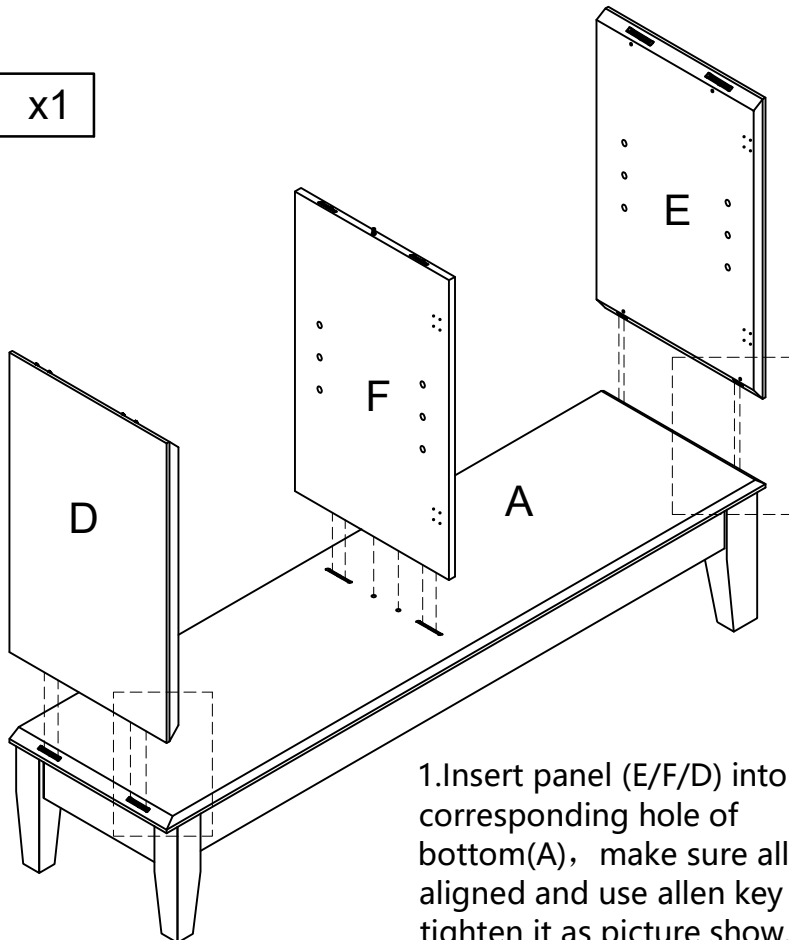



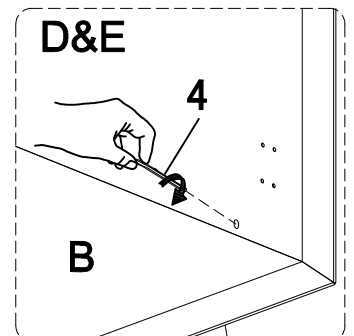
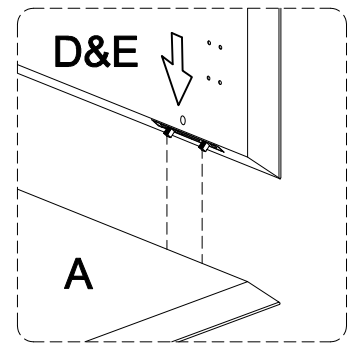

1. Insert panel (E/F/D) into the corresponding hole of bottom(A), make sure all holes aligned and use allen key (4) to tighten it as picture show.



ASSEMBLY INSTRUCTION



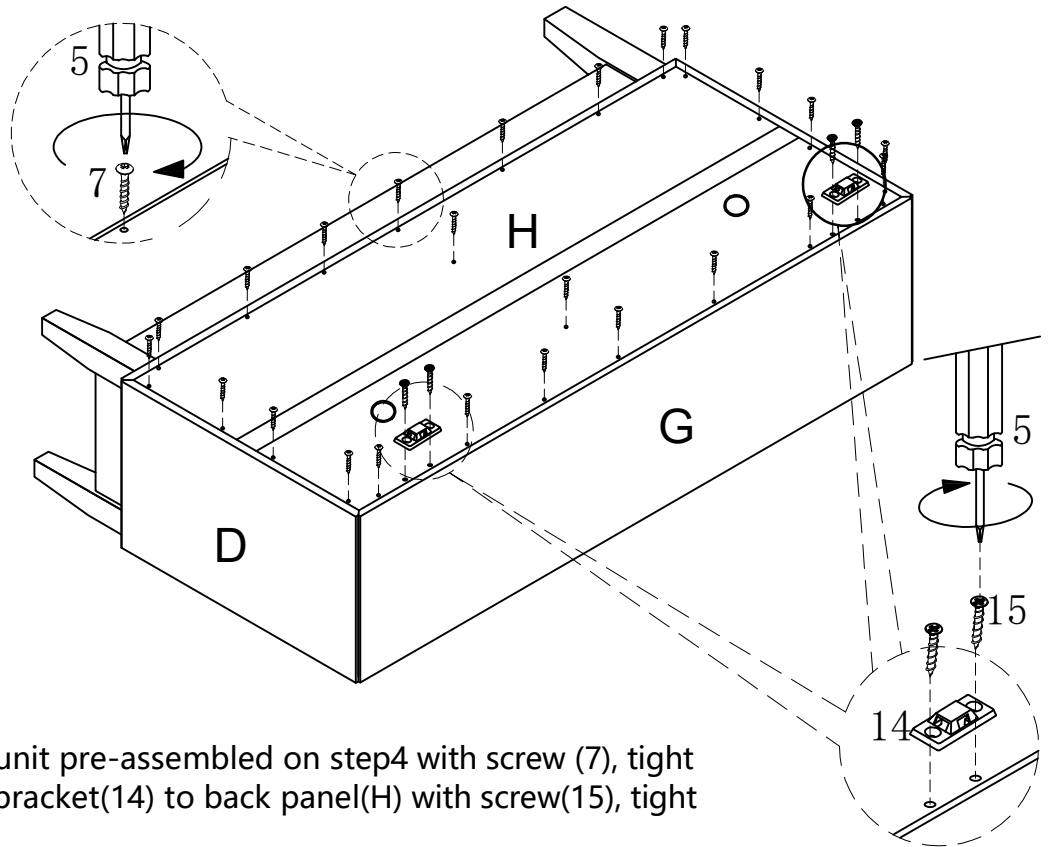

STEP 5

| | | |
|----|---|-----|
| 5 |  | x1 |
| 7 |  | x24 |
| 14 |  | x2 |
| 15 |  | x4 |



Attach back panel (H) to the unit pre-assembled on step4 with screw (7), tight it with screwdriver(5), attach bracket(14) to back panel(H) with screw(15), tight screw with screwdriver(5).

STEP 6



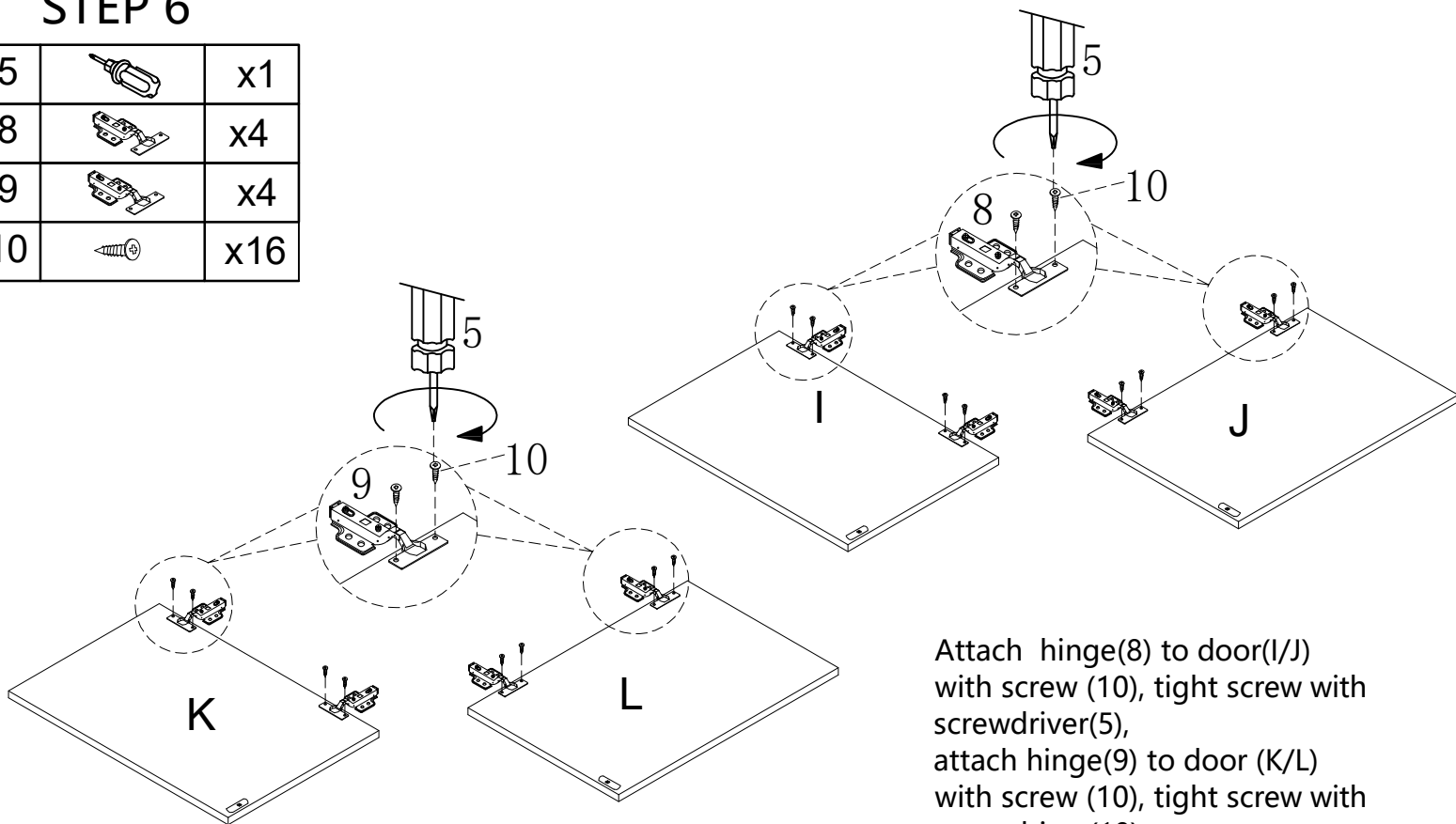

| | | |
|----|---|-----|
| 5 |  | x1 |
| 8 |  | x4 |
| 9 |  | x4 |
| 10 |  | x16 |



Attach hinge(8) to door(I/J) with screw (10), tight screw with screwdriver(5), attach hinge(9) to door (K/L) with screw (10), tight screw with screwdriver(10).

ASSEMBLY INSTRUCTION

STEP 7

| | | |
|----|---|-----|
| 5 |  | x1 |
| 10 |  | x32 |
| 11 |  | x4 |
| 12 |  | x4 |

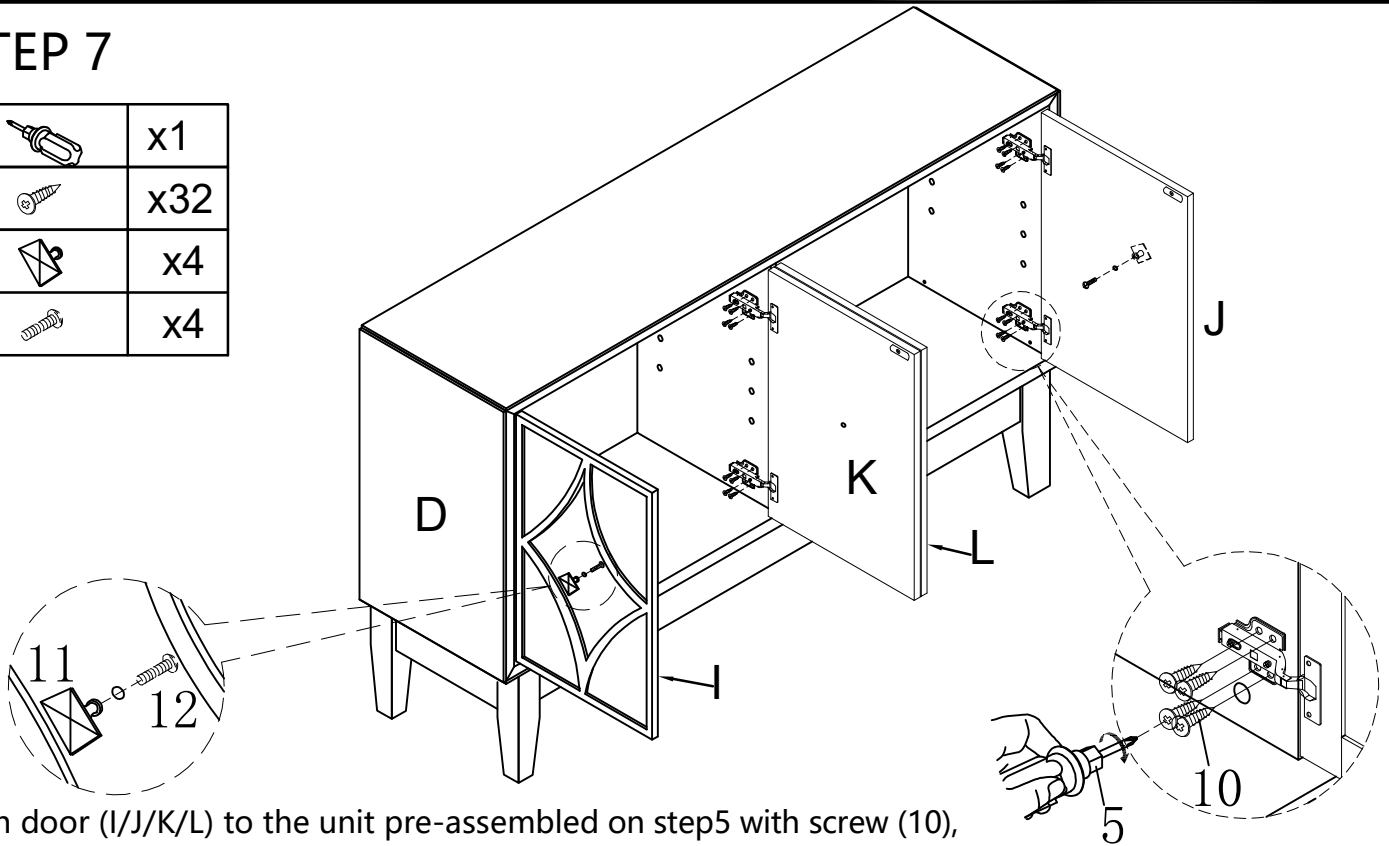

Attach door (I/J/K/L) to the unit pre-assembled on step 5 with screw (10), tight it with screwdriver (5), attach knob (11) to door with bolt (12), tight bolt with screwdriver (5).

STEP 8

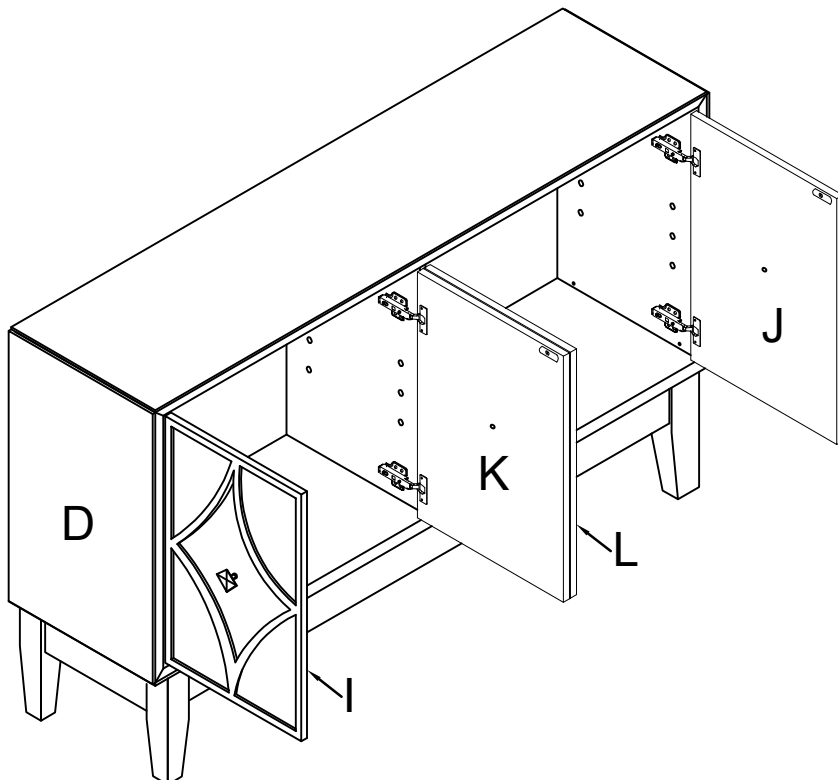

IX: Concealed hinges are three-way adjustable.

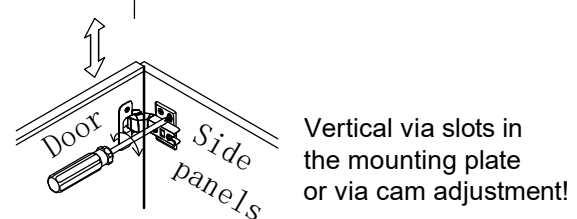
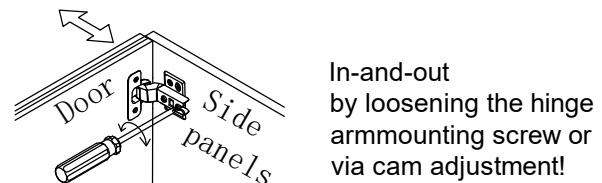
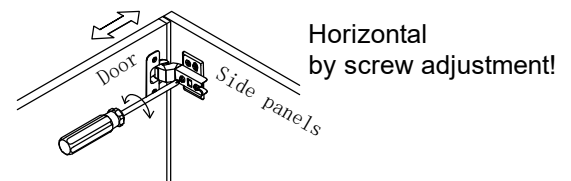

Close the door, if the doors are not at the perfect position, please adjust it as shown.

ASSEMBLY INSTRUCTION

STEP 9

| | | |
|----|---|----|
| 13 |  | x8 |
|----|---|----|

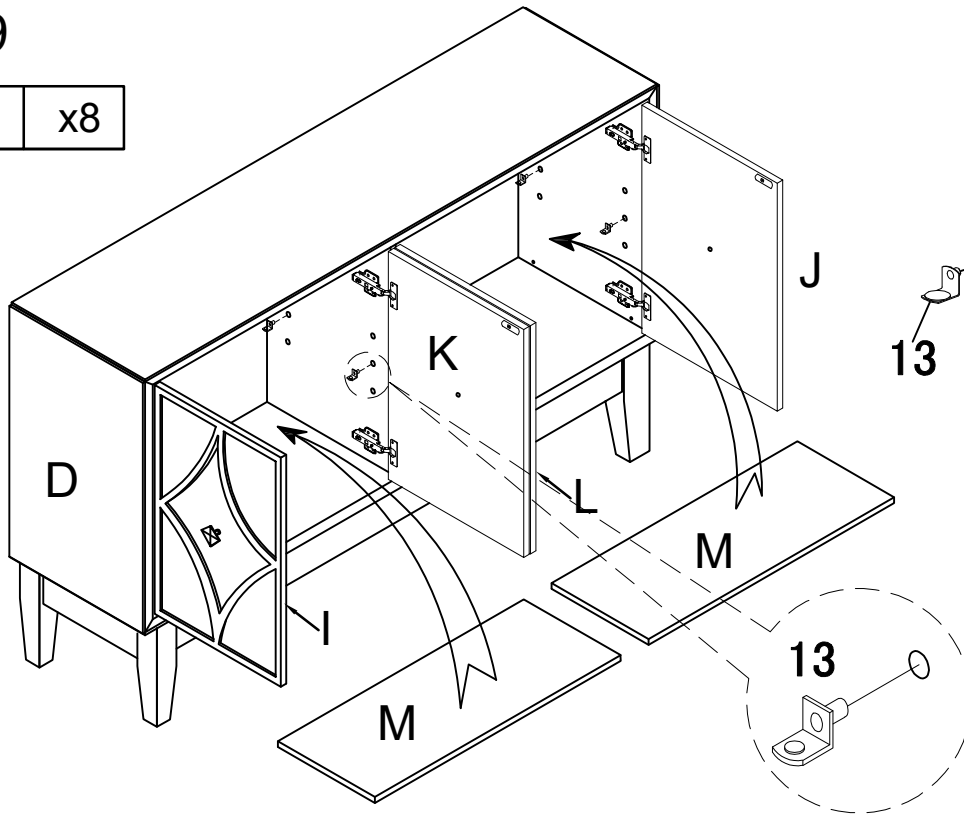



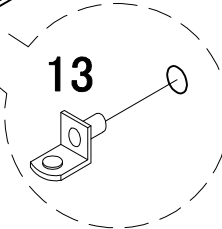
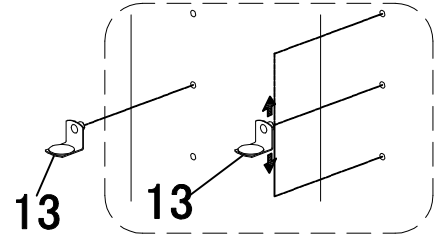

shelf pin can be adjusted up or down



Insert shelf pin (13) to pre-assembled unit at step 8 , and attach adjustable shelf (M) to it

STEP 10

| | | |
|----|---|----|
| 5 |  | x8 |
| 14 |  | x2 |
| 16 |  | x4 |
| 17 |  | x4 |

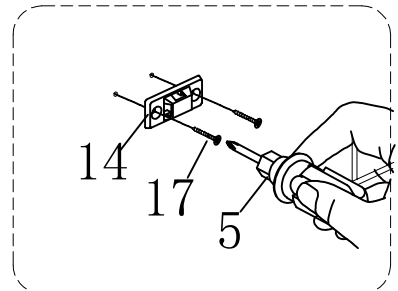
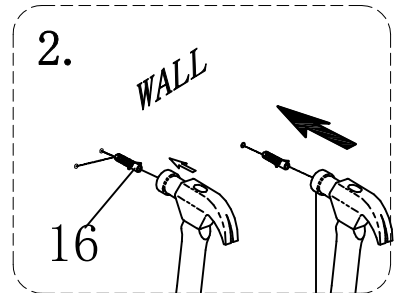
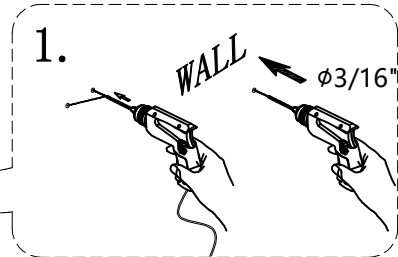
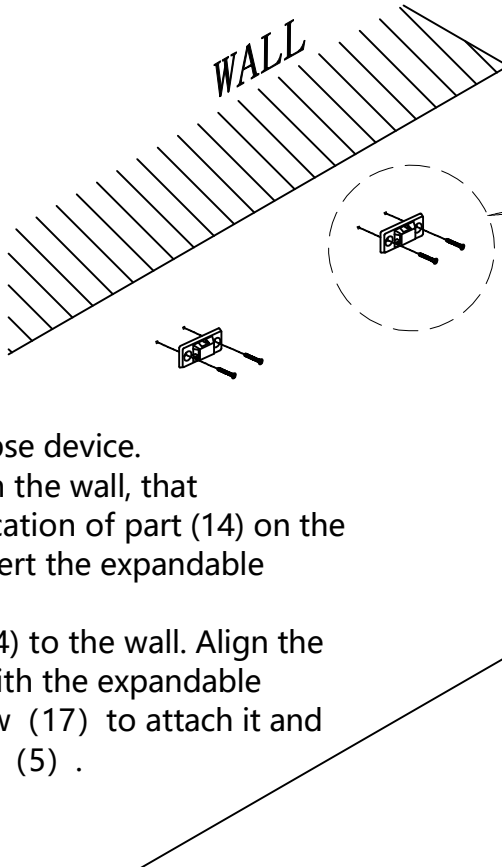

1. Install the anti-collapse device.
2. Mark the position on the wall, that corresponds to the location of part (14) on the panel (H); Drill and insert the expandable screw (16) by hammer.
3. Assemble the part (14) to the wall. Align the hole in the part (14) with the expandable screw (16) , use screw (17) to attach it and tighten by screwdriver (5) .

STEP 11

| | | |
|----|---|----|
| 18 |  | x2 |
|----|---|----|

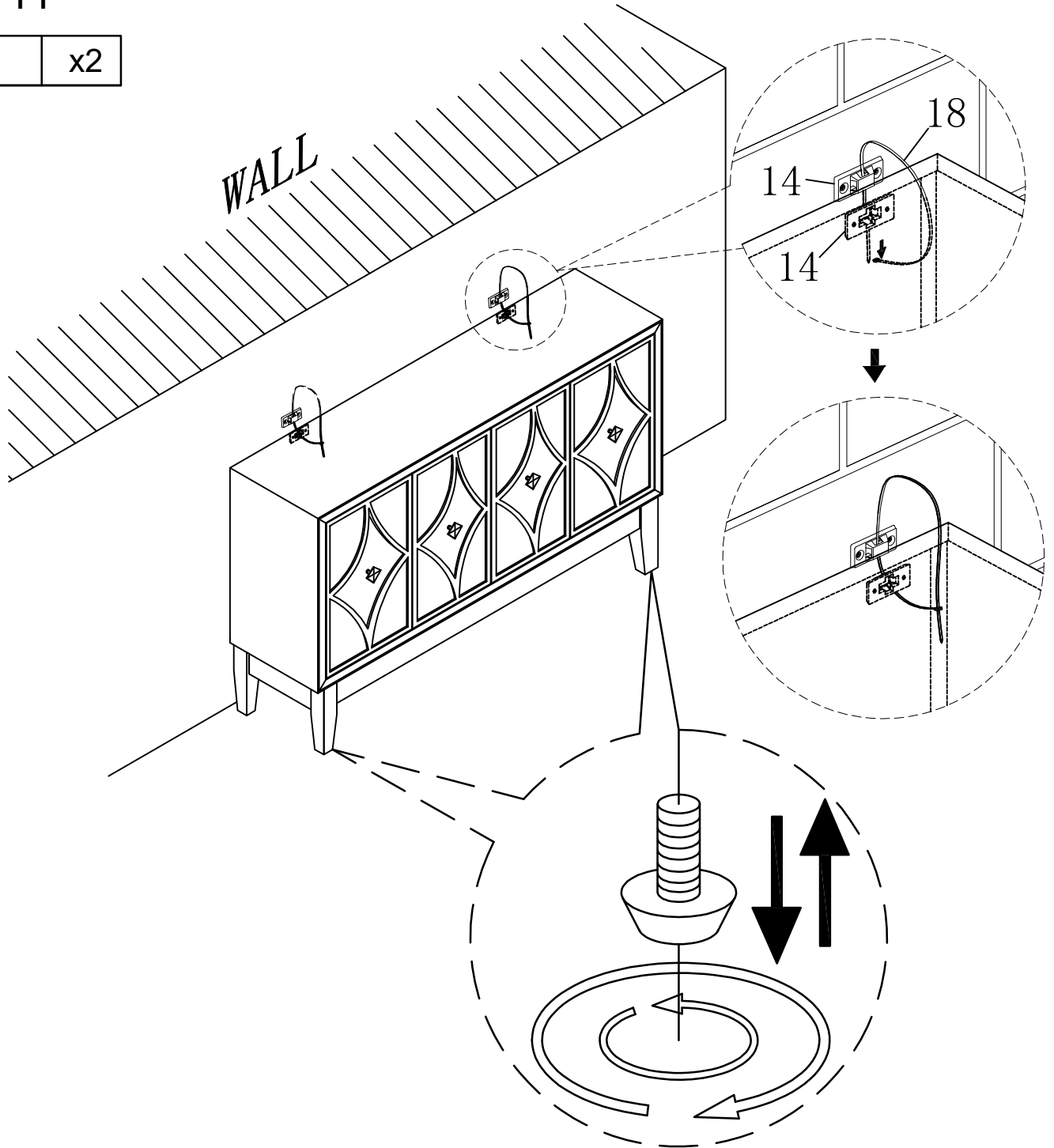

Attach the unit to the wall with tie(18)
Anti-tipping hardware must be used for this product to avoid tipping and injury.
If the unit is not stable , please adjust the adjustable level.

MAINTAINANCE AND WARNING

- keep furniture away from heat.
- Do not clean furniture with harsh cleansers or polish. Do not use detergents, Solvents, abrasives, spray packs or leather cleaner. Use non-color mild soap with warm water clean spills(Mix 1:10 soap to water)
- Do not place furniture under direct sunlight, material will possibly fade over time.
- Do not use on site dry Cleaning machine.
- Children should not climb or jump on the furniture.
- Do not write on furniture without a padded barrier to protect the surface.
- Not for commercial use, For residential use only.
- The maximum load is 150 LBS.

WARRANTY

We strive to offer high-quality products, and we also try our best to satisfy each and every customer that orders from us with product or service as needed. We provide 30 days warranty starting from the time you receive the item. Each customer must provide a record of their order such as the order number, or item receipt for any items that are out of the warranty period you may also still receive replacement parts by purchasing them with our company if they are available.