

**Blackwashed Water Hyacinth
Storage Trunk w/Wood Top
Assembly Instructions**

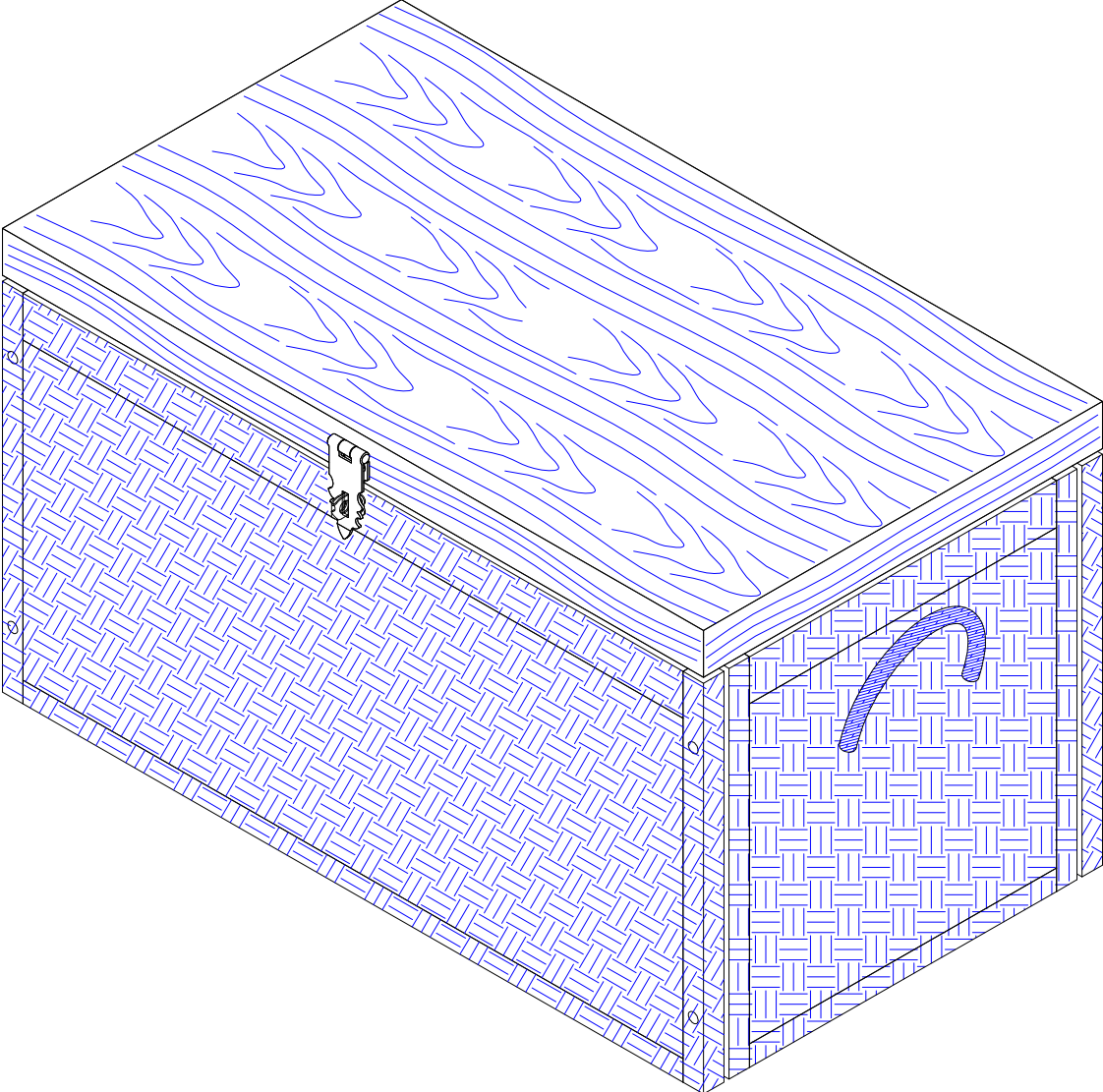

Blackwashed Water Hyacinth Storage Trunk w/Wood Top

Parts List

Please check packaging for all parts and hardware before discarding. Unpack and lay parts on clean, padded surface like carpet or blanket. Check that you have all parts indicated. Call customer service if hardware is missing. Before beginning assembly, carefully study the diagrams below and sort your hardware according to the pictures. Using the incorrect hardware will cause damage.

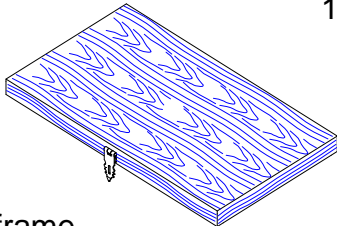
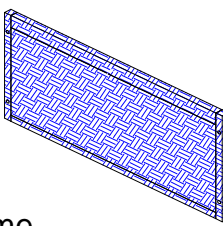
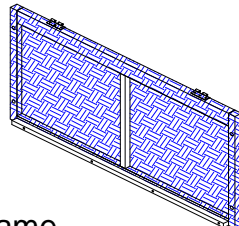
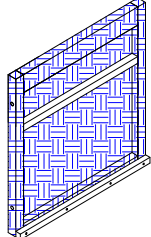
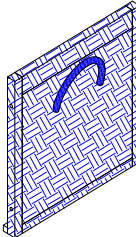
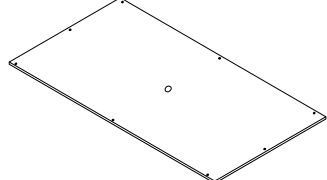
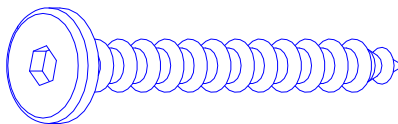
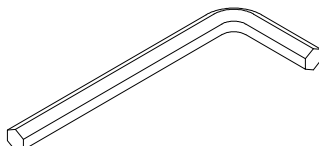
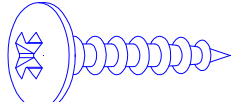
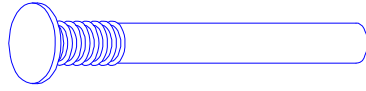
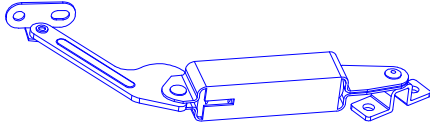
<p>A 1pc</p>  <p>top frame</p>	<p>B 1pc</p>  <p>front frame</p>	<p>C 1pc</p>  <p>back frame</p>
<p>D 1pc</p>  <p>left frame</p>	<p>E 1pc</p>  <p>right frame</p>	<p>F 1pc</p>  <p>bottom panel</p>
<p>1 8pcs</p>  <p>allen screw</p>	<p>2 1pc</p>  <p>allen key</p>	<p>3 16pcs</p>  <p>round screw</p>
<p>4 4pcs</p>  <p>bolt</p>	<p>5 2pcs</p>  <p>safety hinge</p>	

Care and Cleaning Instructions:

Before using, wipe with a clean, dry cloth. Periodically apply furniture wax to renew the finish. Avoid rubbing or scratching the surface with rough or abrasive objects.

Assembly Tool Required
No.2 Phillips Screwdriver

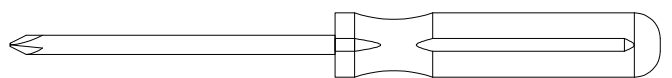

Blackwashed Water Hyacinth Storage Trunk w/Wood Top

Top Assembly Instructions

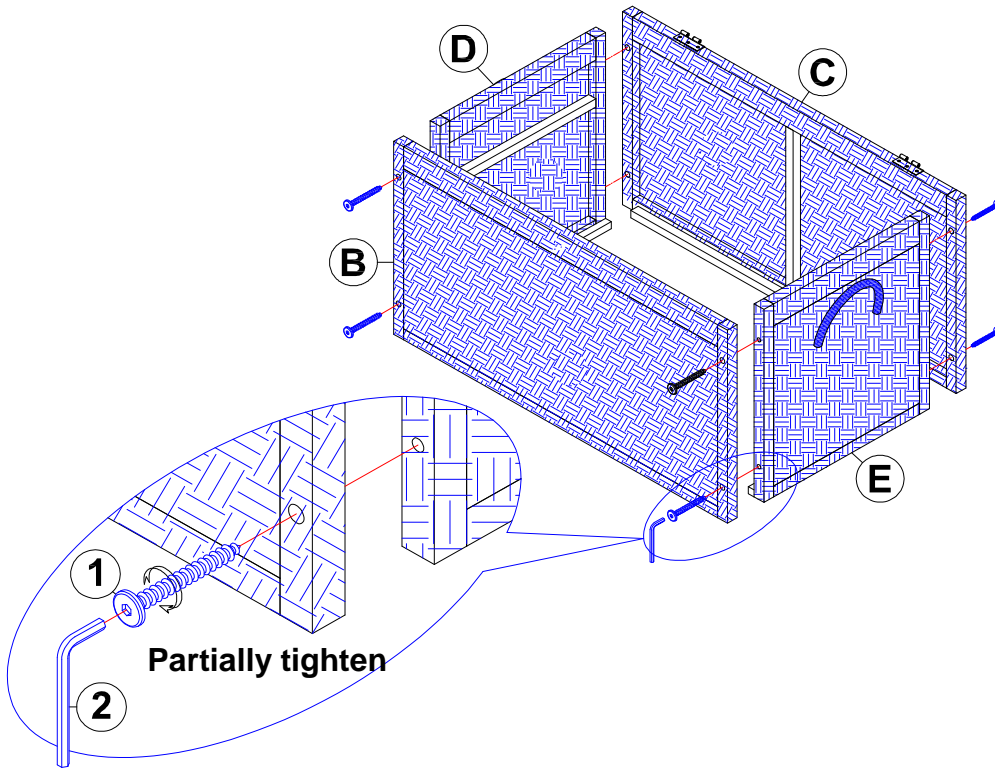

Step 1:

Attach front frame (B) and back frame (C) to left frame (D) and right frame (E) with 8pcs allen screw (1).

Using allen key (2), partially tighten all allen screws (1) as shown.

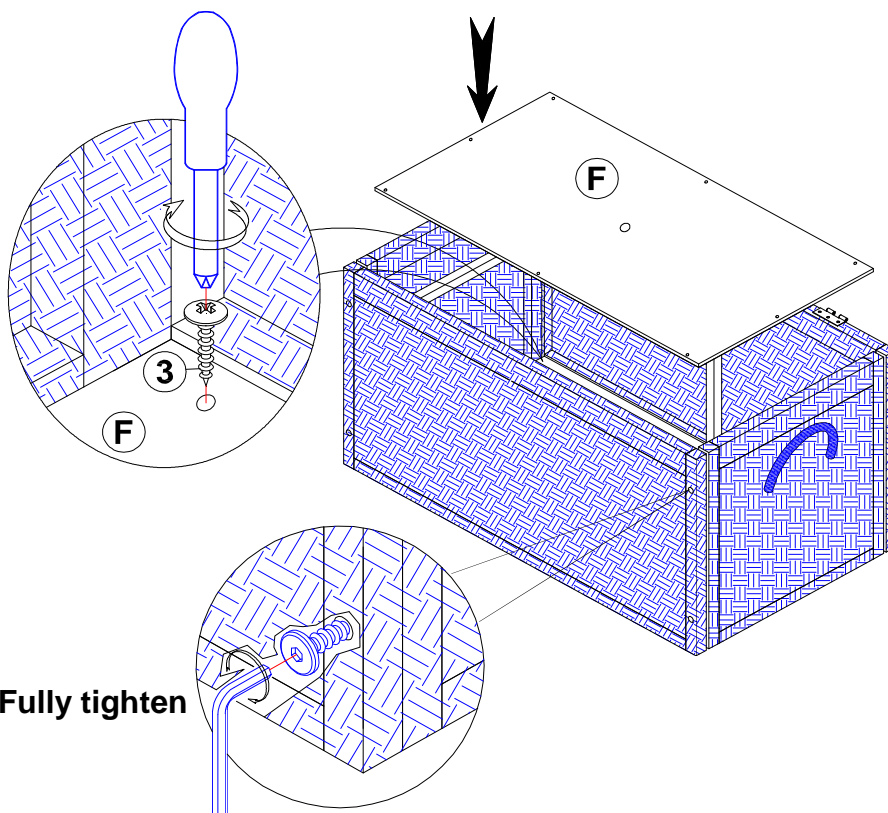

Step 2:

Attach bottom panel (F) inside the trunk.

Fully tighten all allen screws.

Using screw driver, tighten 8pcs round screws (3) as shown.

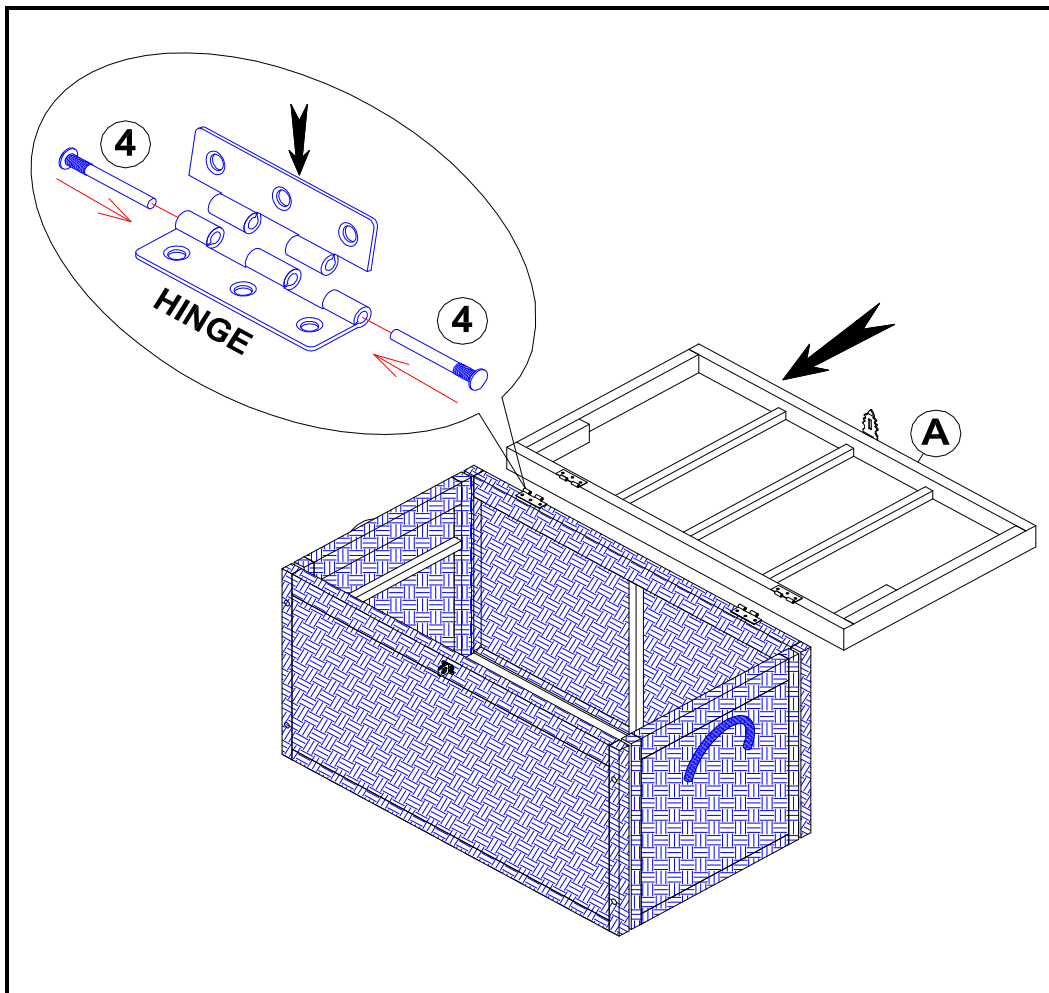

Step 3:

Attach top frame (A) to back frame (C) by attaching the pre-installed hinges on the top frame to the hinges on the back frame using 4pcs bolt (4) as shown.

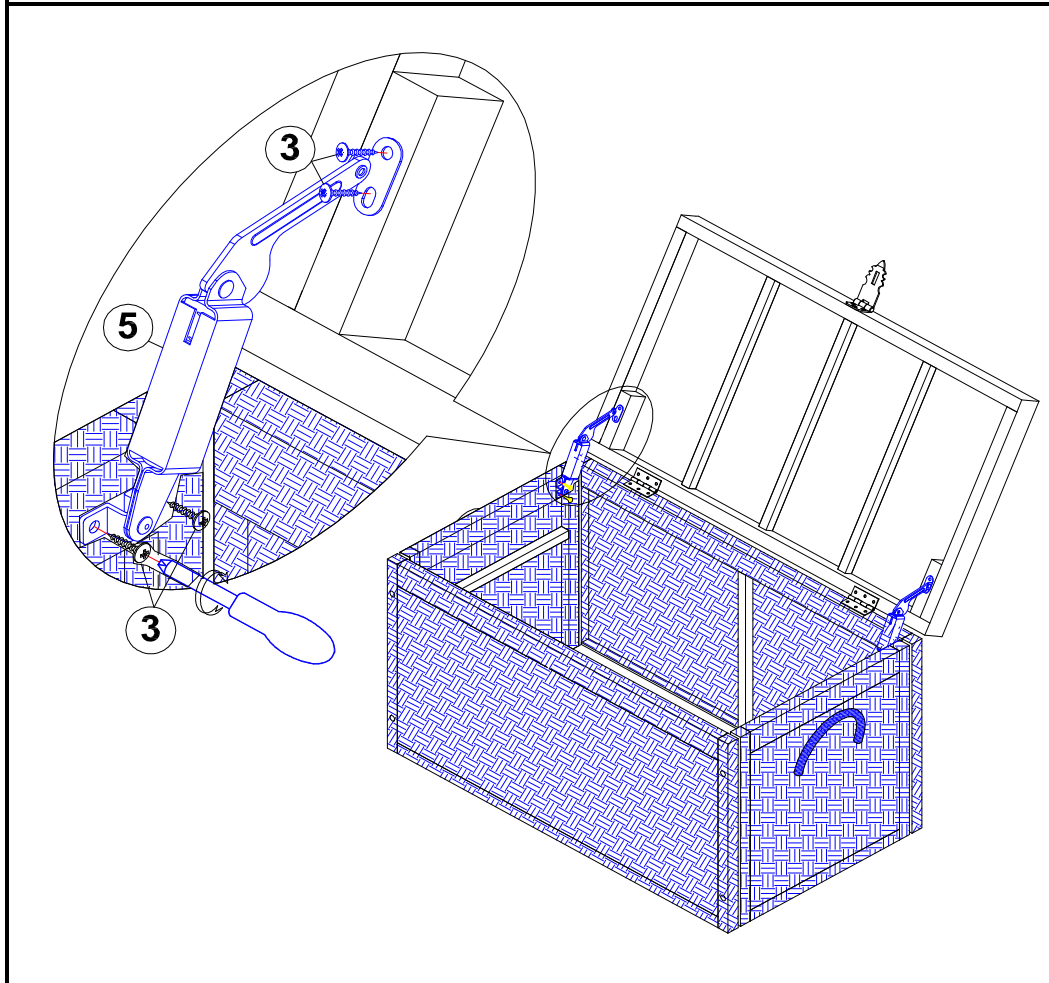

Step 4:

Attach 2pcs safety hinges (5) to pre-drilled holes on left frame (D), right frame (E), and top frame (1) using screwdriver. Tighten 8pcs round screws (3) for the safety hinges as shown.

ASSEMBLY IS COMPLETE

Parts Replacement Form

Customer Information

Name _____

Address _____

City/State/Zip Code _____

Phone Number _____

Please indicate where you purchased this item: Store/Website/Catalog

Please indicate color/size/style number:

Style No	Parts Letter	Parts Description	Quantity Needed
_____	_____	_____	_____
_____	_____	_____	_____
_____	_____	_____	_____