

ASSEMBLY INSTRUCTIONS

TOOLS REQUIRED



Allen Wrench

(Included)

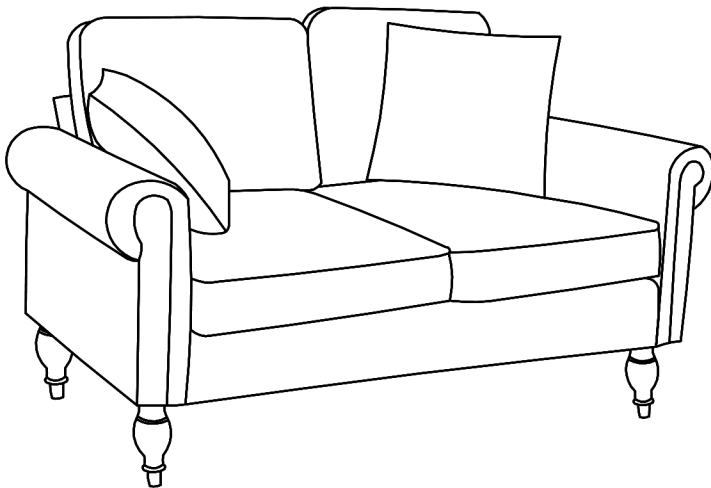

**2 - People
Recommended**

ASSEMBLY RATING



EASY —————> **DIFFICULT**

The Assembly Rating is a 5-point system showing the level of effort needed to assemble a specific product.



CHECK BEFORE STARTING

Are you missing anything?

Double-check all parts, hardware and accessories listed on Page 6 are accounted for.

Check out our Quick Tips!

We recommend reviewing the pre-assembly handouts. Even experts need a refresher now and then!

Should we send any replacements?

Are there any irregularities or flaws in the parts? We can send replacements!

Prep Time!

Please review the assembly instructions and all diagrams prior to assembling. Arrange parts as recommended on Page 7 and group identical hardware together to make assembling easier.

PRE ASSEMBLY INTRODUCTION

We understand building ready-to-assemble furniture can be a challenging experience for some. To help avoid confusion, we have provided some helpful tips that may speed up the process.

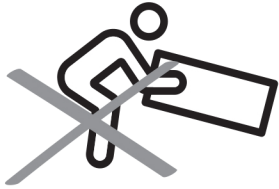

Teamwork

ALWAYS have at least two people to help with transporting and assembling the product to avoid potential injury and/or damage.

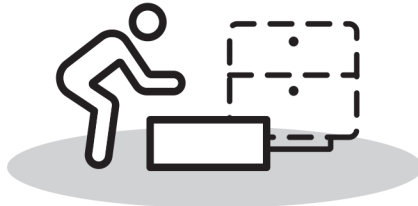
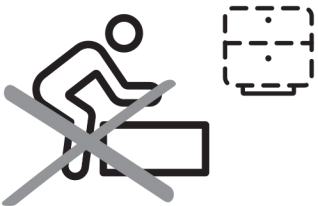

Suitable Location

Assembling near the area of the intended location is highly recommended.



Sufficient Space

Make sure you have enough space to move around during the assembly.



Avoid Scratches

Use cardboard, blankets or a carpeted area while assembling furniture to prevent scratches.

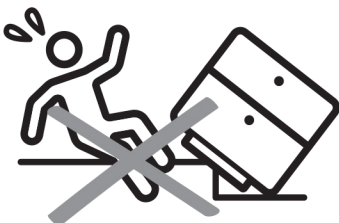

Flat Surface

Make sure the furniture rests on a flat and level surface with each leg evenly touching the floor.

ASSEMBLY AND CARE ADVICE



FAILURE TO FOLLOW THE GUIDELINES BELOW MAY RESULT IN INJURY AND/OR PROPERTY DAMAGE.



Position each part correctly and insert screws or bolts into their respective holes.

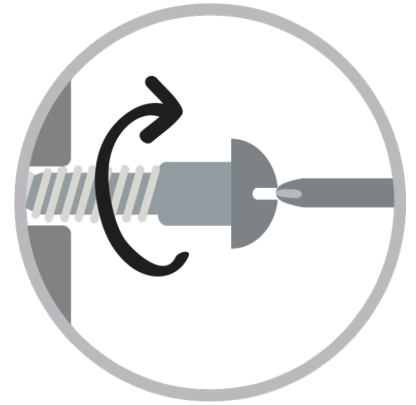

Turn clockwise to tighten and only tighten when step is completed or when instructed to do so.



Use the appropriate hand tools or power tools for assembly. Select steps, such as tightening screws and/or bolts, may require hand tools to avoid causing damage during assembly.



Save the instructions and store any supplied tools for later maintenance.

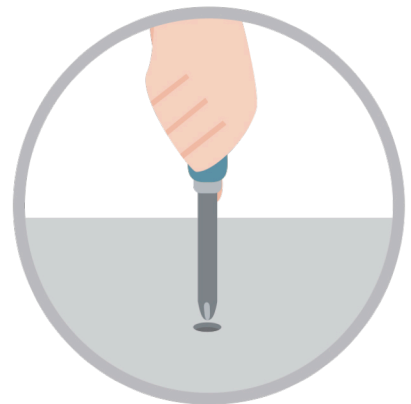

After two weeks, check and tighten any loose hardware and repeat again every six months thereafter.

IT IS THE USER'S RESPONSIBILITY TO MAINTAIN THE FURNITURE. THE HARDWARE MAY LOOSEN OVER TIME AND MAY CAUSE THE FURNITURE TO BE WOBBLY AND UNABLE TO SUPPORT ITS INTENDED WEIGHT CAPACITY. THIS MAY LEAD TO COLLAPSE AND MAY CAUSE SERIOUS INJURY.

LOVESEAT



- Please keep instructions for future reference.
- Check the quantity and irregularity of parts and hardware before you start.

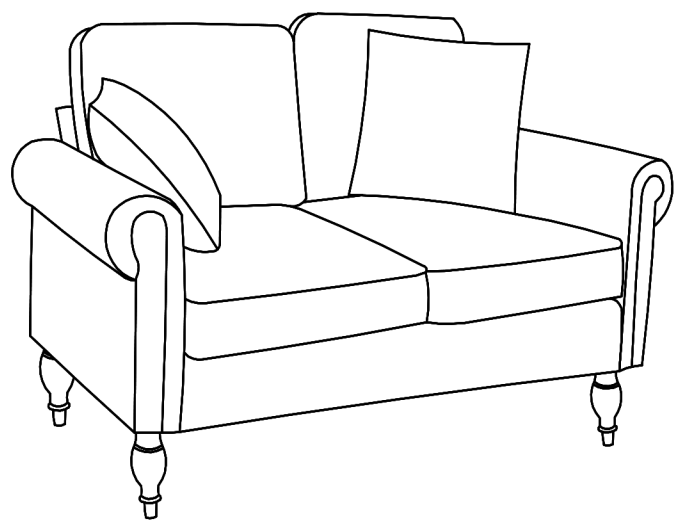

PARTS

#1 1pc

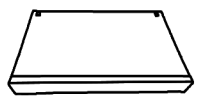

seat

#2 2pcs

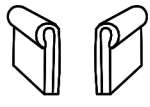

Arm(L&R)

#3 1pc

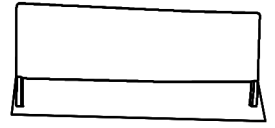

Seat Back

#4 2pcs

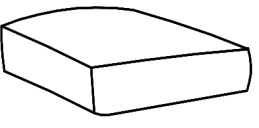

Seat Cushion

#5 2pcs

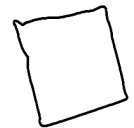

Pillow

#6 2pcs



Back Cushion

#7 4pcs



Leg

#8 2pcs

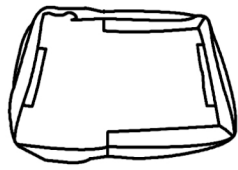

Seat Cushion Cloth Sleeve

#A 12pcs

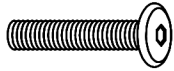

Bolt Ø8 x 60mm

#B 16pcs



Flat Washer

#C 1pc







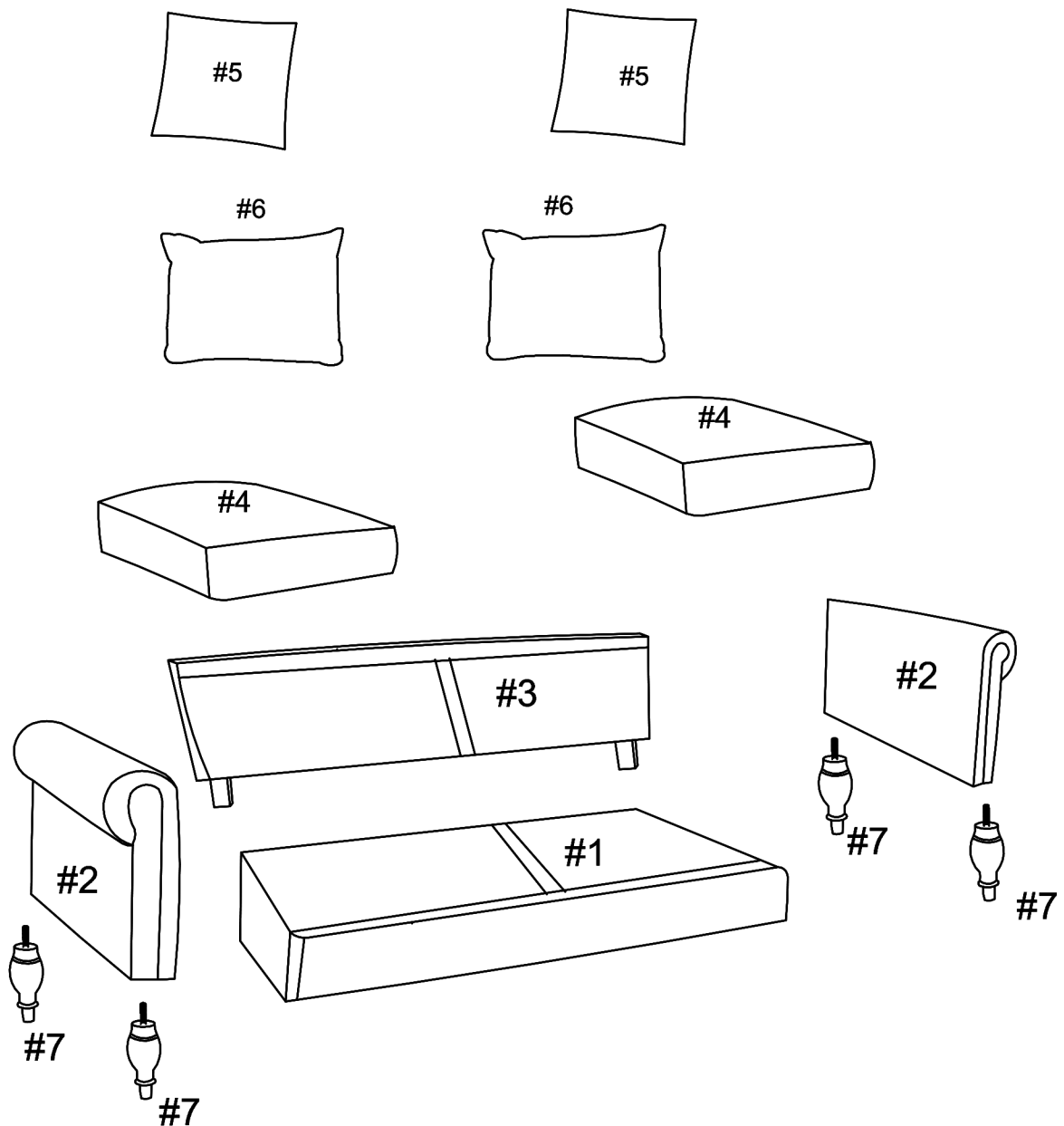

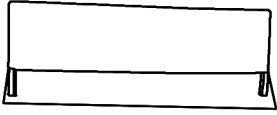

Allen Wrench

Exploded View

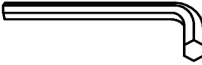

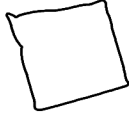
CM6473LV is packed in 2 cases

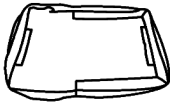
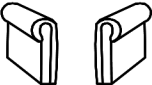
Carton	Disignation		Part	Hardware
CM6437LV-1	seat	#1		 #A x 12pcs
	Seat Back	#3		 #B x12pcs  #C x 1pc
	Seat Cushion	#4	 x2	
	Pillow	#5	 x 2	
	Back Cushion	#6	 x 2	
	Leg	#7	 x 4	
	Seat Cushion Cloth Sleeve	#8	 x 2	
CM6437LV-2	Arm	#2	 x 2	

ASSEMBLY INSTRUCTIONS

1

Part #1 x1pc

Part #2 x2pcs

Hardware #A x8pcs

Hardware #B x8pcs

Hardware #C x1pc

Align and attach Arm (#2) to Seat (#1) by using Bolt (#A) with Washer (#B)

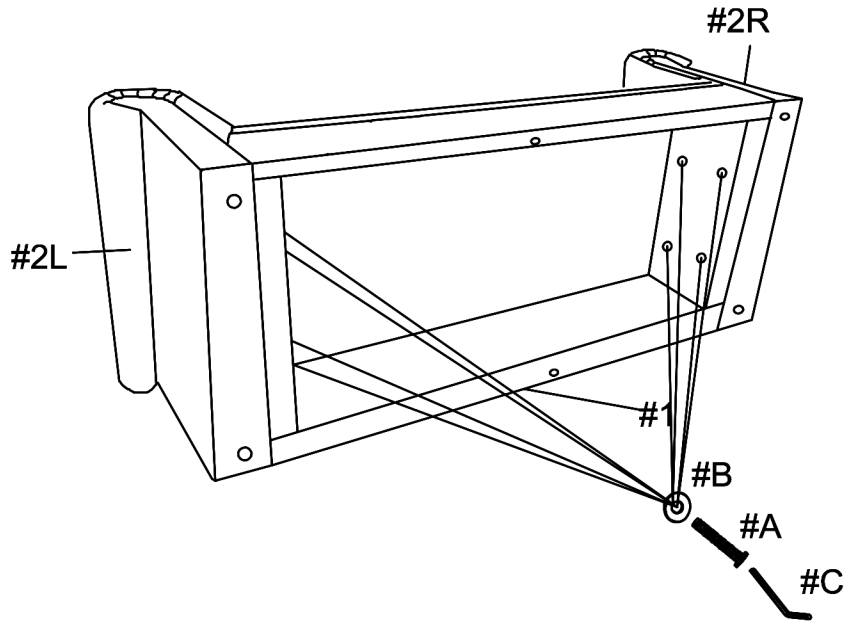

2

Part #7 x4pcs

Screw Leg (#7) to Seat (#1)

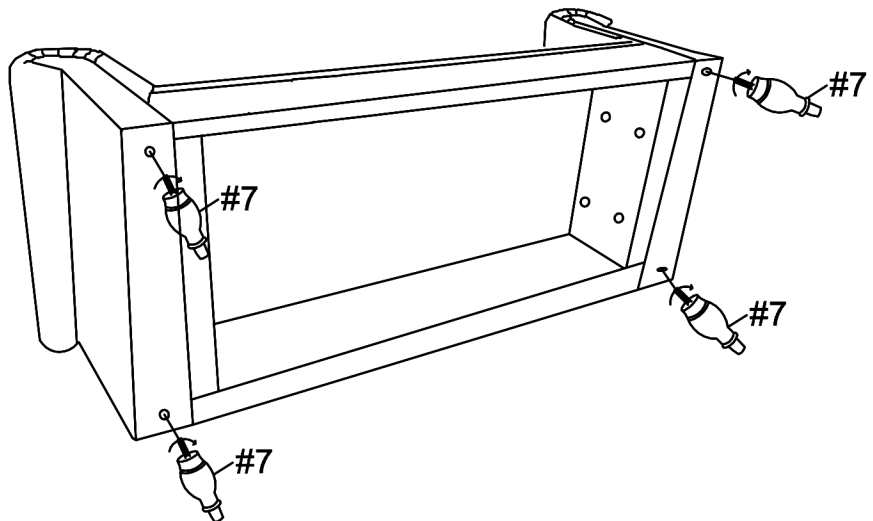

ASSEMBLY INSTRUCTIONS

3

Part #3 x 1pc

Hardware #A x4pcs

Hardware #B x4pcs

Hardware #C x1pc

Align and attach Seat Back (#3) to Seat (#1) by using Bolt (#A) with Washer (#B)

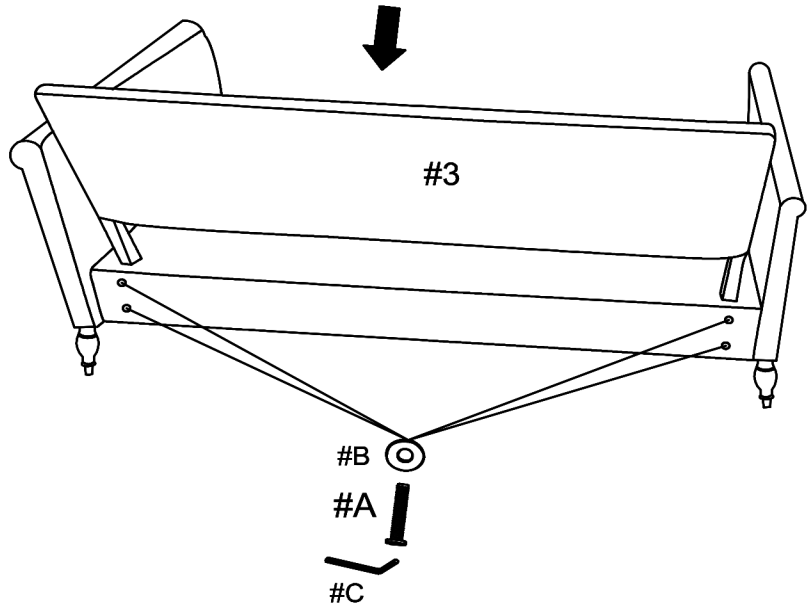

4

Part #4 x2pcs

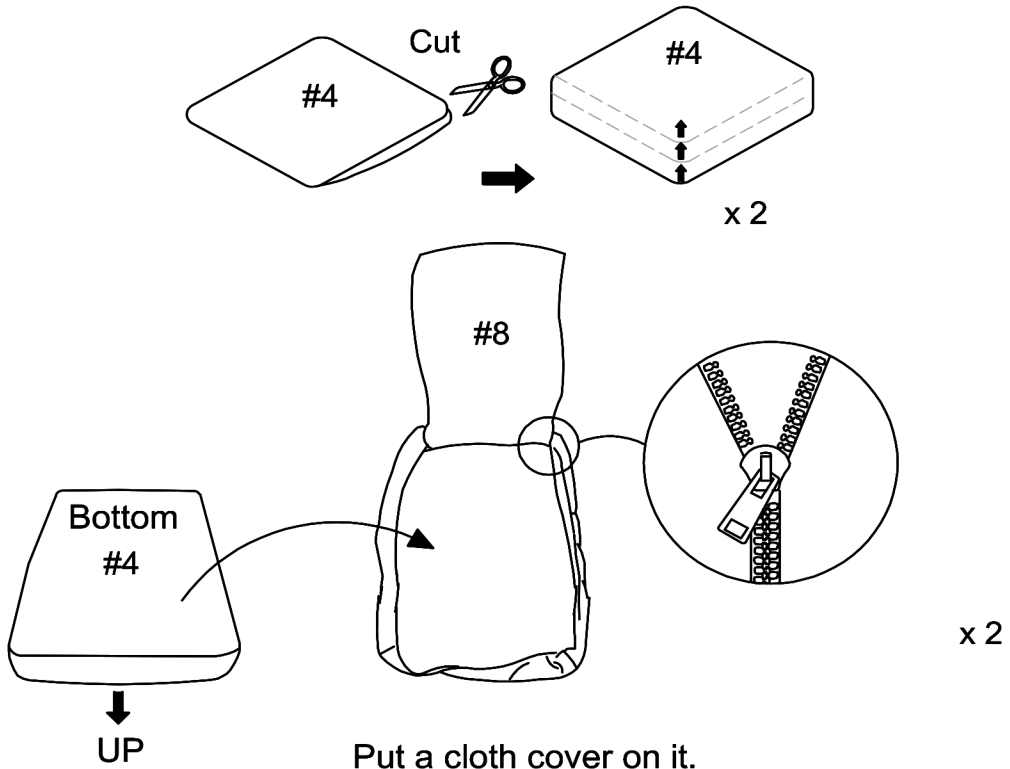

ASSEMBLY INSTRUCTIONS

5

Part #4 x 2pcs

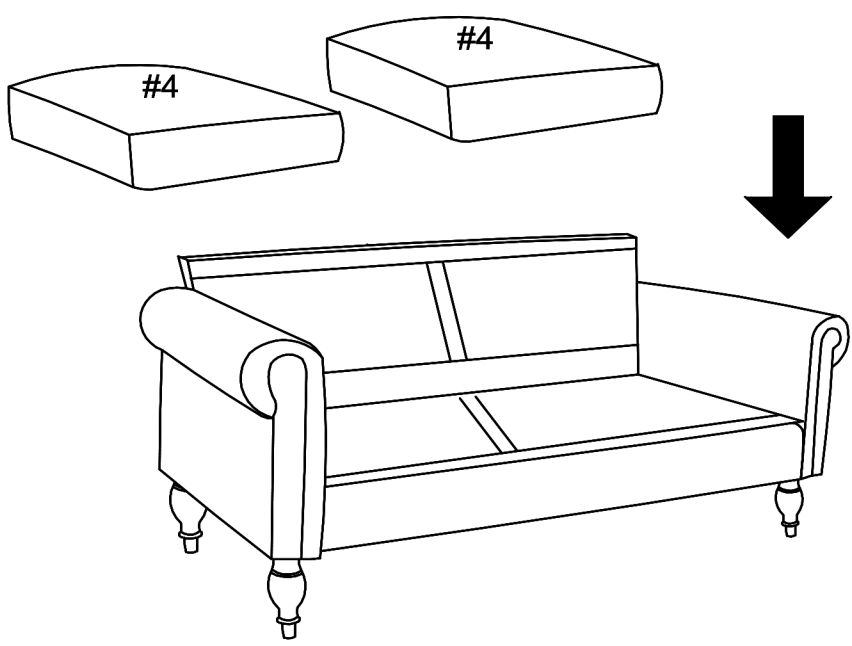

6

Part #5 x2pcs

Part #6 x2pcs

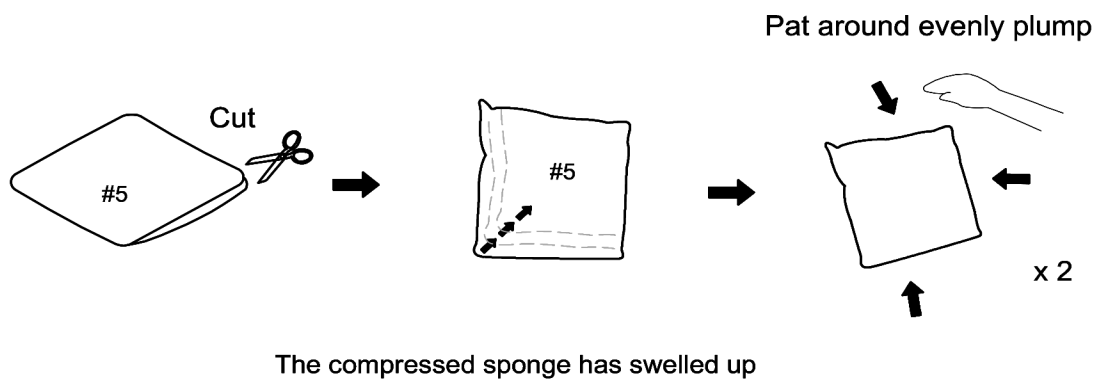
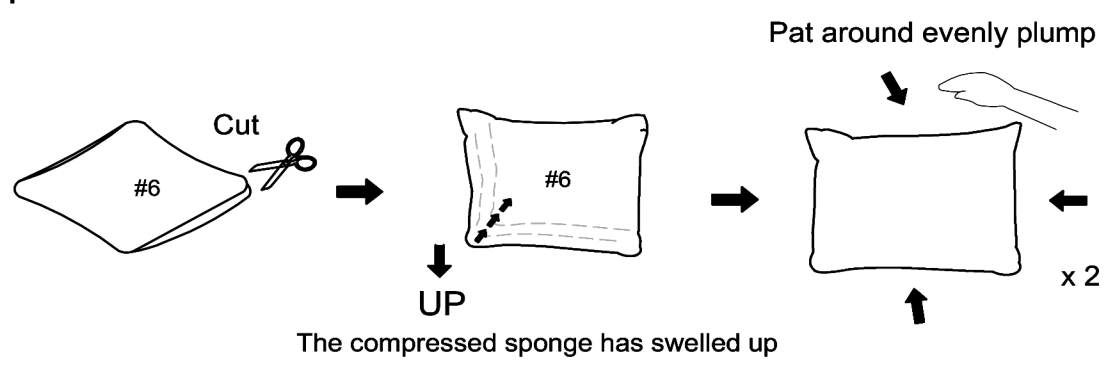

ASSEMBLY INSTRUCTIONS

7

Part #6 x2pcs

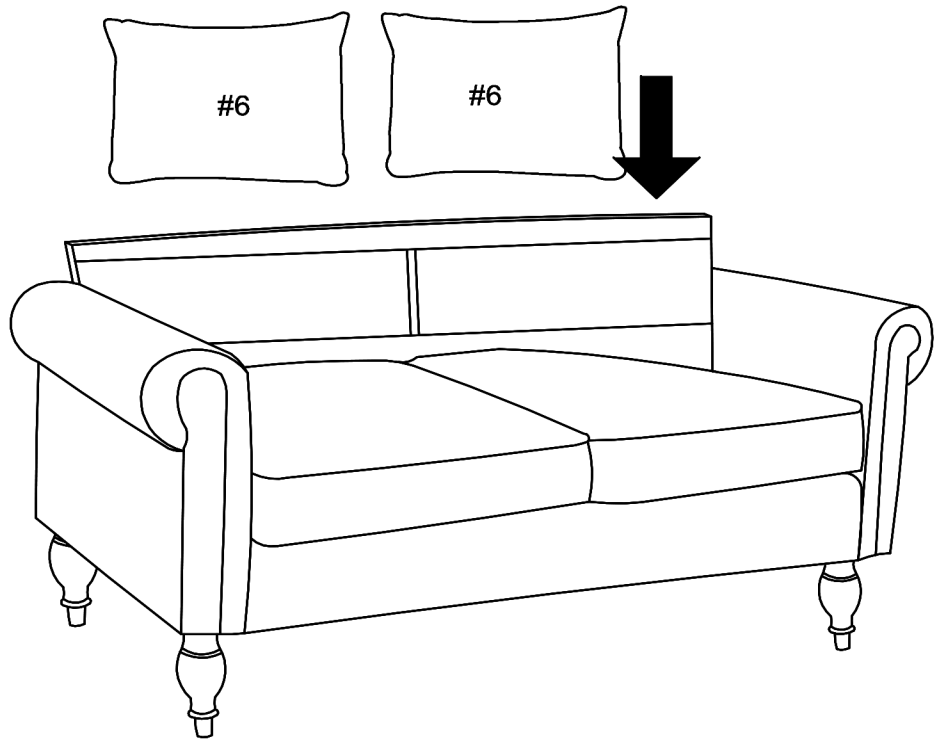

8

Part #5 x 2pcs

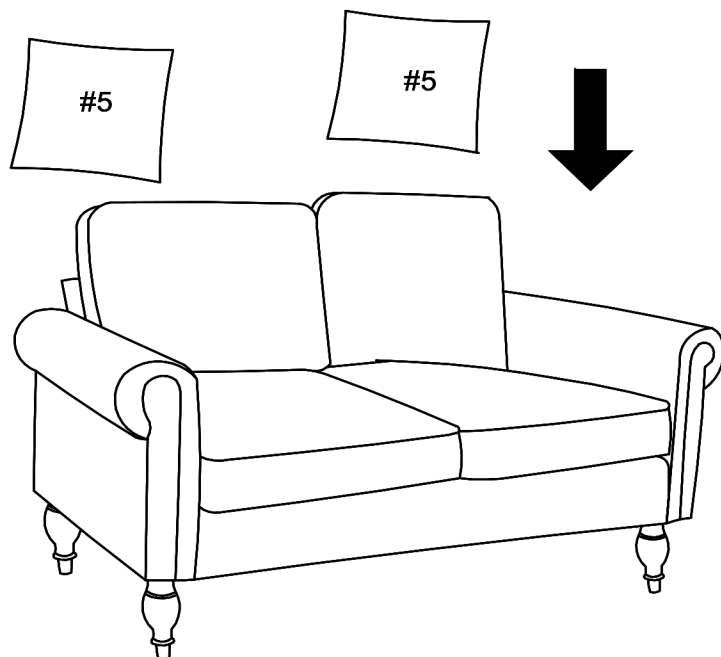

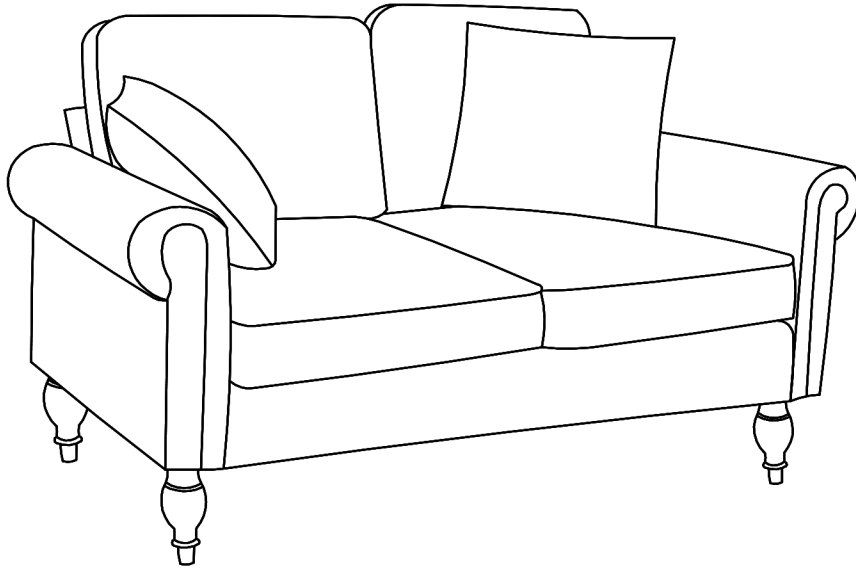

ASSEMBLY COMPLETED



Please ensure the furniture rests on an even and flat surface. If the product wobbles or feels loose, double-check all bolts and/or screws are properly tightened and secured.



Keep this handy!

Please retain this instruction manual and any order-related information for future reference.



Lift, don't drag!

To avoid damage to product please always LIFT the product when transporting or adjusting the placement.