

**INSTRUCTIONS D'ASSEMBLAGE
ASSEMBLY INSTRUCTIONS**

**BUREAU 60"L MÉTAL ARGENT / BLANC HOLLOW-CORE
WHITE HOLLOW-CORE / SILVER METAL 60"L OFFICE DESK**



**POUR DE L'ASSISTANCE OU POUR COMMANDER
DES PIÈCES CONTACTEZ NOTRE DÉPARTEMENT
DE SERVICE À LA CLIENTÈLE.**

**FOR ASSISTANCE OR TO ORDER PARTS
CONTACT OUR CUSTOMER SERVICE DEPARTMENT**



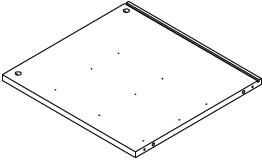
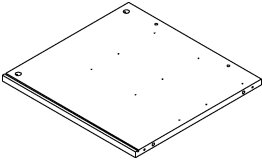
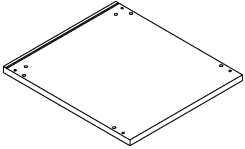
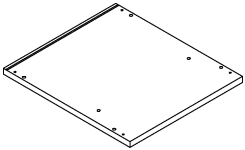
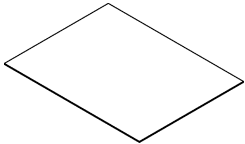
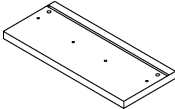
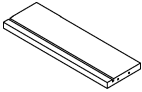
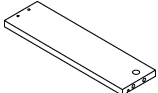



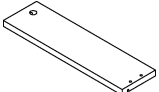
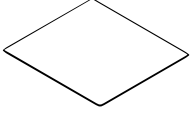
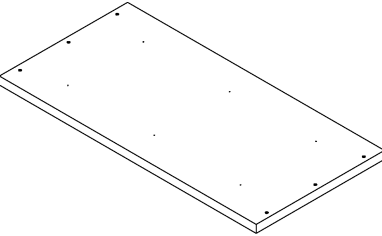
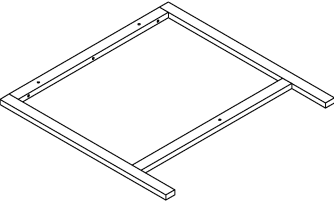
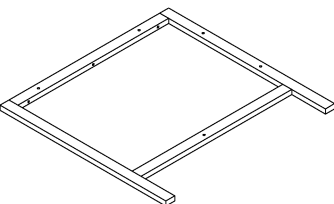
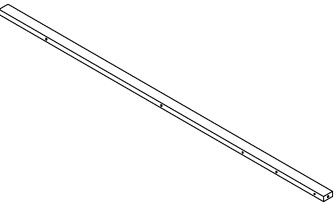
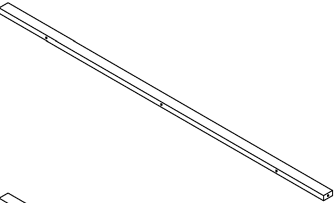
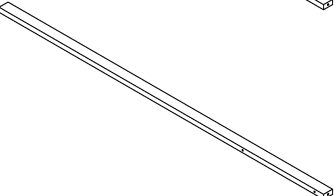



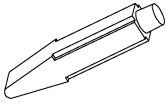
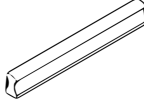
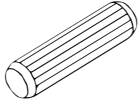

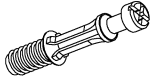
IDENTIFICATION DES PIÈCES PARTS IDENTIFICATION

1		PANNEAU CÔTÉ GAUCHE LEFT SIDE PANEL	1MC 1PC
2		PANNEAU CÔTÉ DROIT RIGHT SIDE PANEL	1MC 1PC
3		PANNEAU DU BAS BOTTOM PANEL	1MC 1PC
4		PANNEAU DU DESSUS TOP PANEL	1MC 1PC
5		PANNEAU ARRIÈRE BACK PANEL	1MC 1PC
6		PANNEAU DEVANT DU TIROIR DRAWER FACE PANEL	3MCX 3PCS
7		PANNEAU ARRIÈRE DU TIROIR DRAWER BACK PANEL	3MCX 3PCS
8		PANNEAU CÔTÉ GAUCHE DU TIROIR LEFT DRAWER SIDE PANEL	3MCX 3PCS

IDENTIFICATION DES PIÈCES PARTS IDENTIFICATION

9		PANNEAU CÔTÉ DROIT DU TIROIR RIGHT DRAWER SIDE PANEL	3MCX 3PCS
10		PANNEAU DU FOND DU TIROIR DRAWER BOTTOM PANEL	3MCX 3PCS
11		PANNEAU DU DESSUS TOP PANEL	1MC 1PC
12		PATTE (GAUCHE) LEG (LEFT)	1MC 1PC
13		PATTE (DROIT) LEG (RIGHT)	1MC 1PC
14		BARRE TRANSVERSALE CROSSBAR	1MC 1PC
15		BARRE TRANSVERSALE CROSSBAR	1MC 1PC
16		BARRE TRANSVERSALE CROSSBAR	1MC 1PC

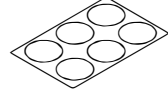
IDENTIFICATION DES PIÈCES DE MONTAGE
HARDWARE IDENTIFICATION

A		15g	1MC / PC	I		L 120mm	3MCX / PCS
B		∅8 x 30mm	14MCX / PCS	J		27.5mm	6MCX / PCS
C		35.5mm	10MCX / PCS	K		63mm	6MCX / PCS
D		∅15x12mm	10MCX / PCS	L		27.5mm	6MCX / PCS
E		42mm	4MCX / PCS	M		61.4mm	12MCX / PCS
F		35mm	12MCX / PCS	N		57x21mm	1MC / PC
G		L 350mm	3 ENS/SET	O		∅20mm	2MCX / PCS
H		10mm	42MCX / PCS				

ÉTAPE / STEP 1

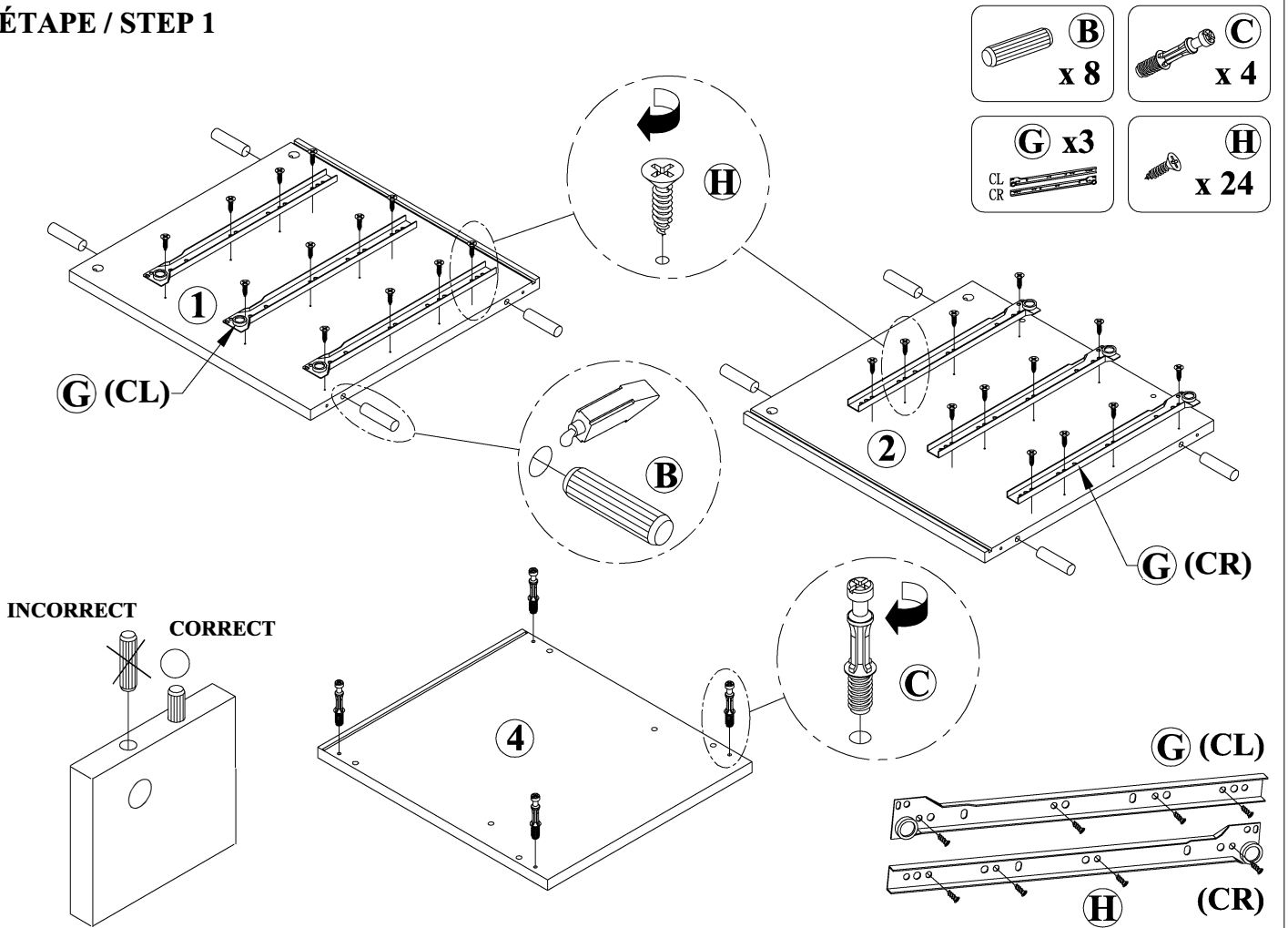

ÉTAPE / STEP 2

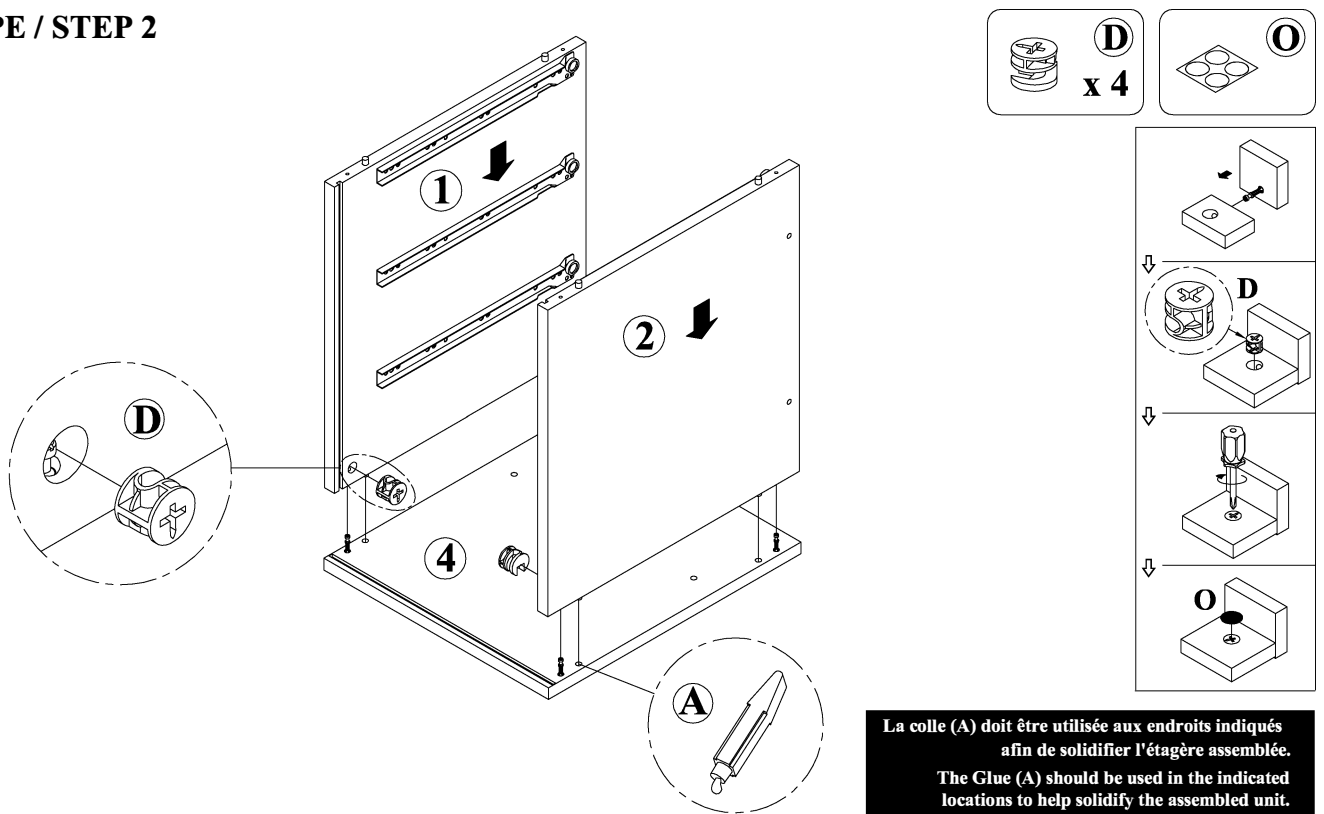

La colle (A) doit être utilisée aux endroits indiqués afin de solidifier l'étagère assemblée.
The Glue (A) should be used in the indicated locations to help solidify the assembled unit.

ÉTAPE / STEP 3

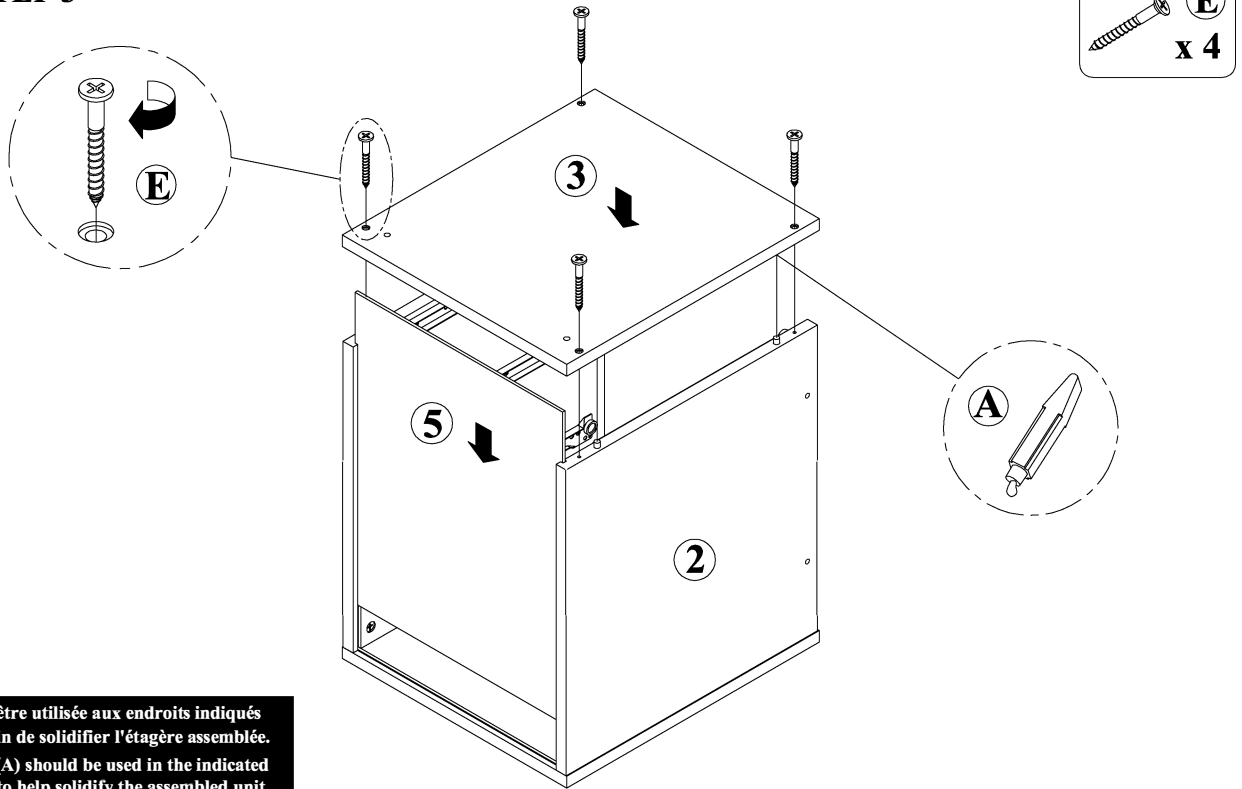

La colle (A) doit être utilisée aux endroits indiqués
afin de solidifier l'étagère assemblée.
The Glue (A) should be used in the indicated
locations to help solidify the assembled unit.

ÉTAPE / STEP 4

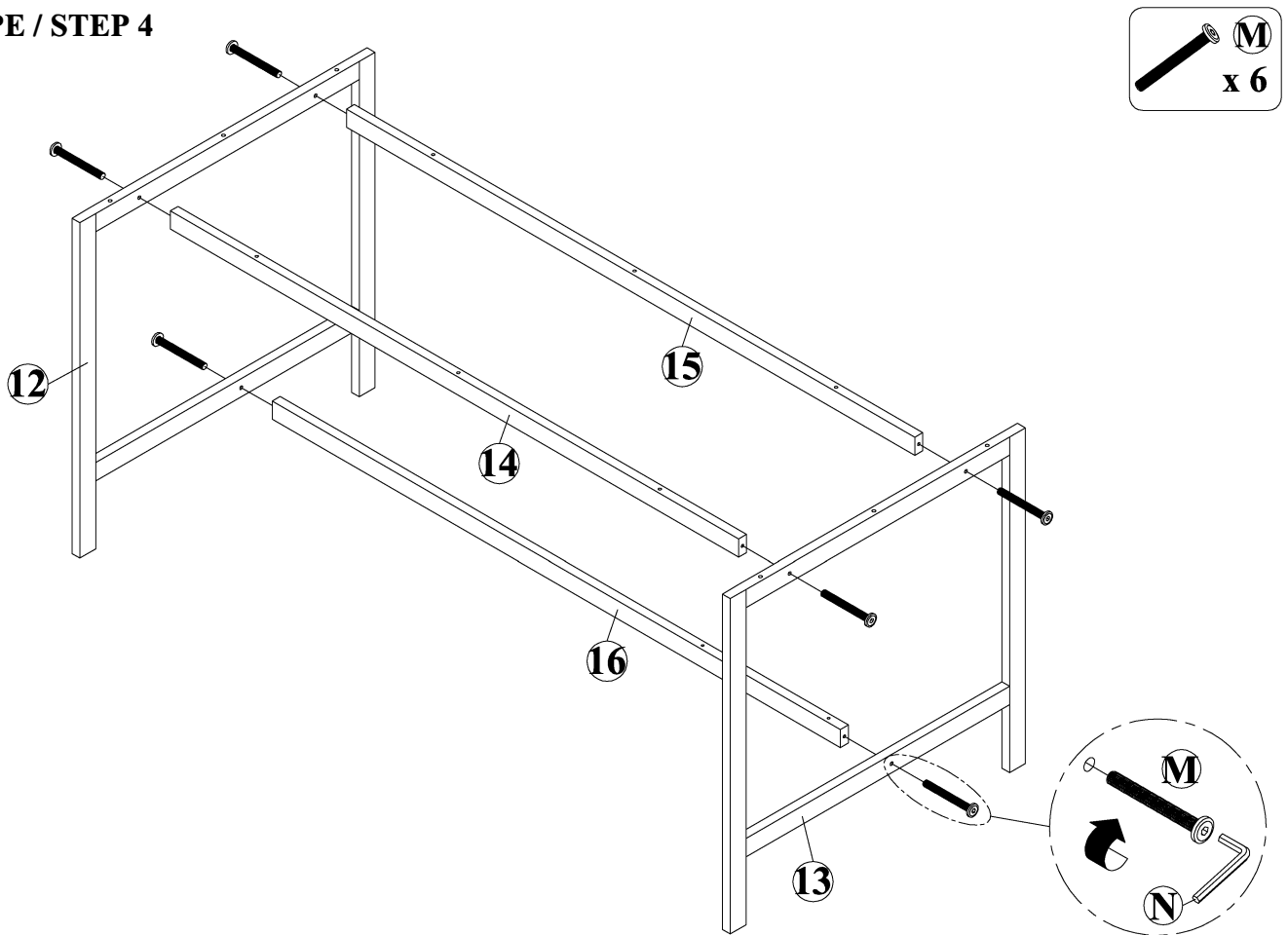

ÉTAPE / STEP 5

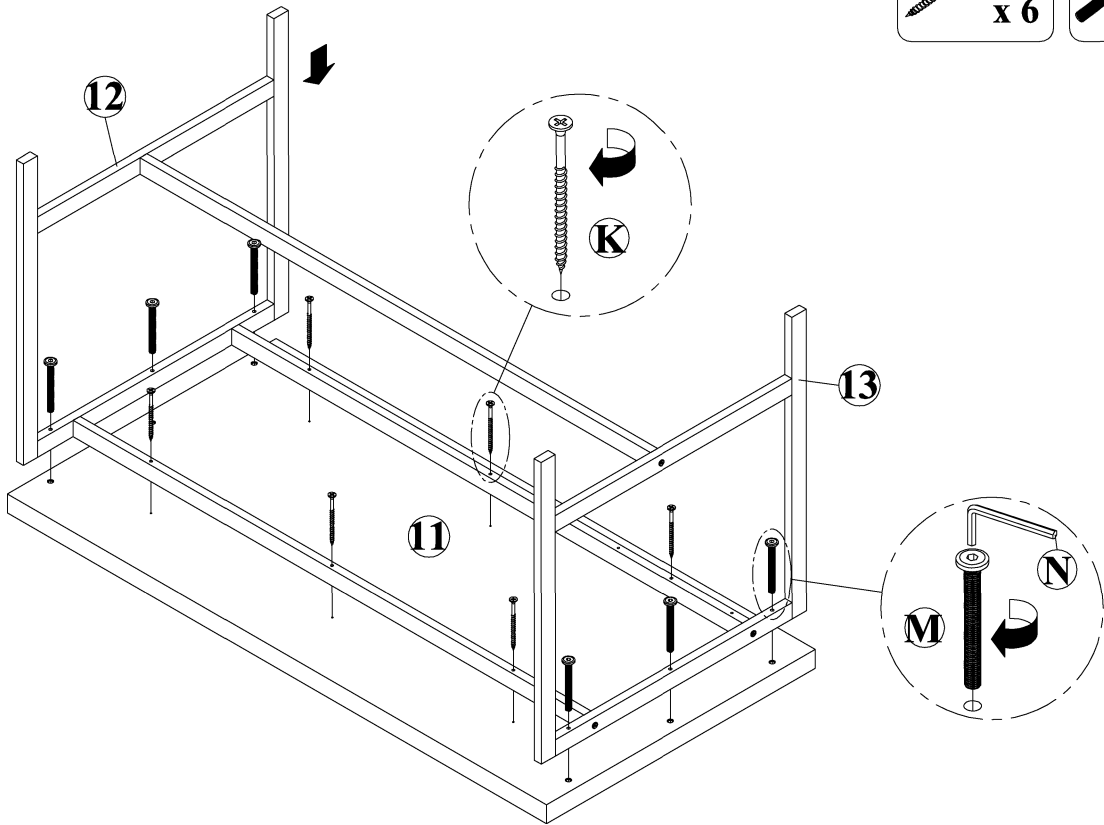
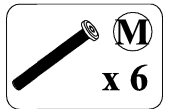
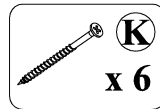

ÉTAPE / STEP 6

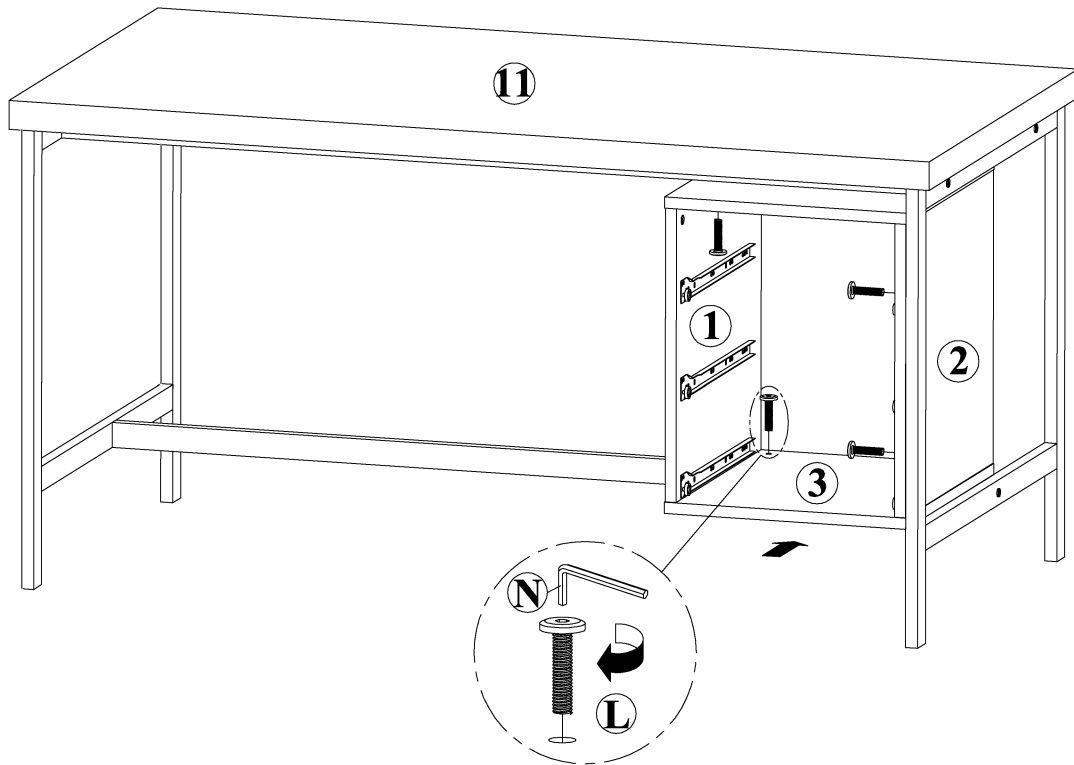
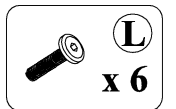

ÉTAPE / STEP 7

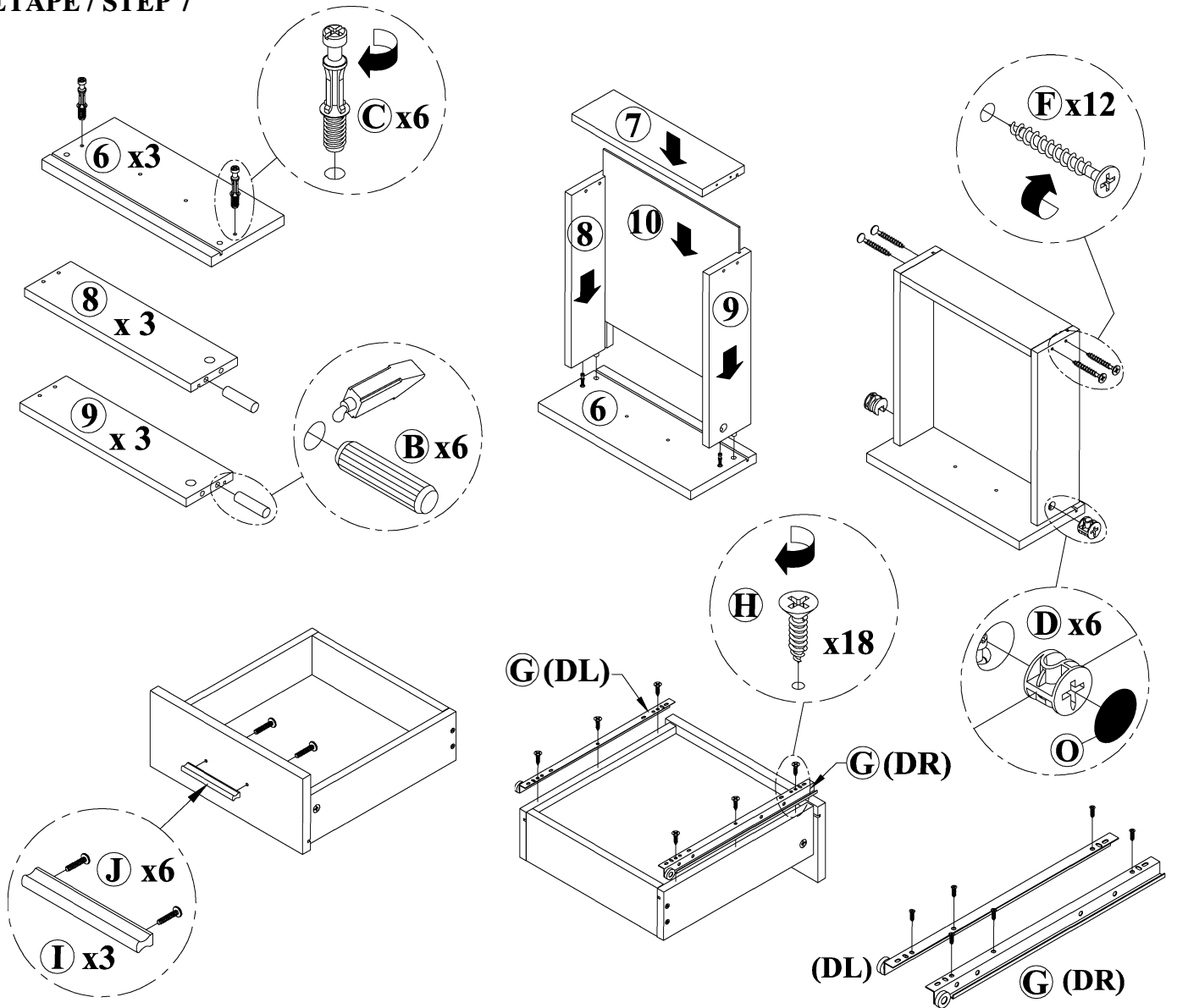

ÉTAPE / STEP 8

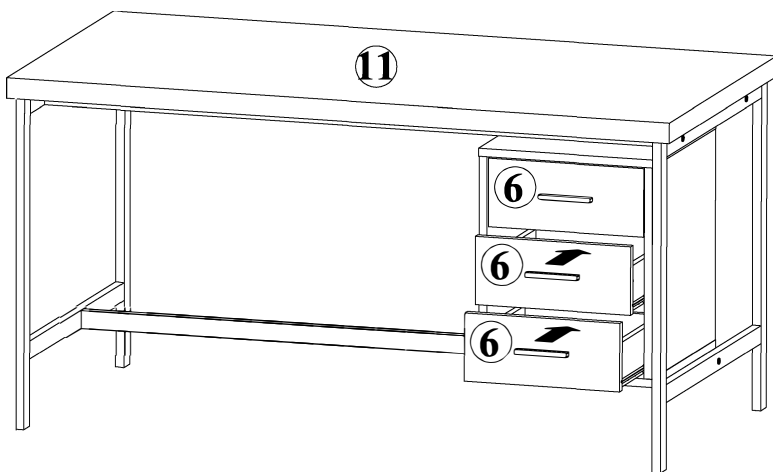

TERMINER / FINISH

