

# ■ Dining Chair

## ASSEMBLY INSTRUCTION



---

SKU:5294

Dear customer, Thank you very much for buying our items. Please read the assembly instruction carefully before assembly.

## Notices:

- Verify that all parts are present and in good condition before assembly.
- Put the chair on a clean flat surface.
- Please tighten the screws to about 80% for the first step; Then, sit with caution on the chair to adjust the balance; Finally, tighten all the screws to 100%.
- If you find that is unlevel after assembly, you can use adjustable pegs to keep four legs level.

## Contact us

If there are installation problems, damage, missing parts, or any questions and concerns, please contact the shop where you bought it so we can make things right.

If the product is damaged, please send the following information:

- Photos that show the reason for your claim/damage.
- Photos of the packaging (inside and outside).

Thank you very much for your support!

# Package Contents

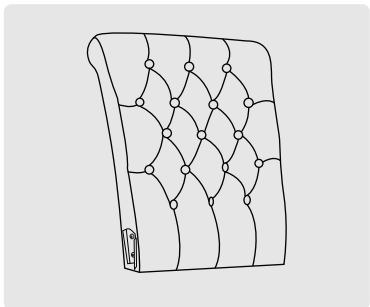

Back

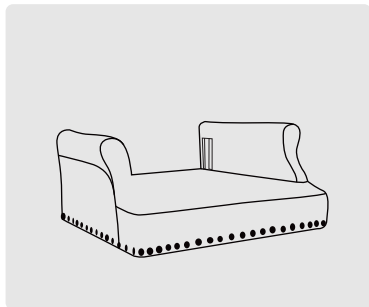

Seat

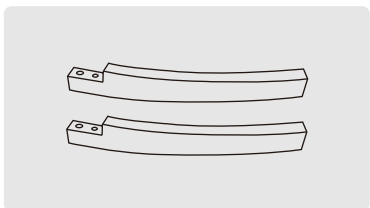

Hind Legs  
(curved)

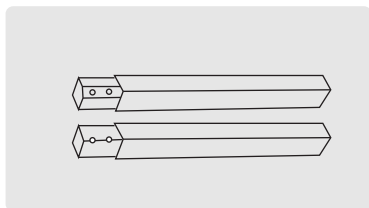

Front Legs  
(straight)

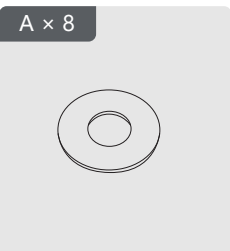

Washer

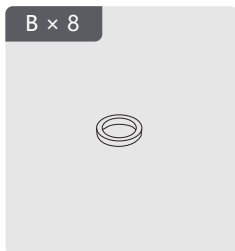

Spring Washer

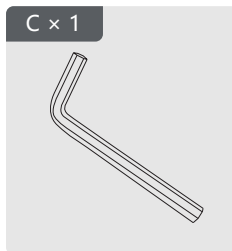

Spanner

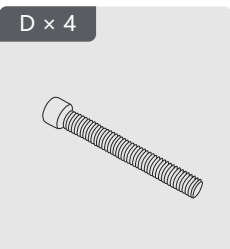

M8x60mm  
Screws

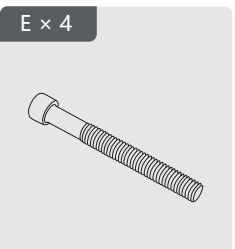

M8x65mm  
Screws

# Step by Step Guide

1

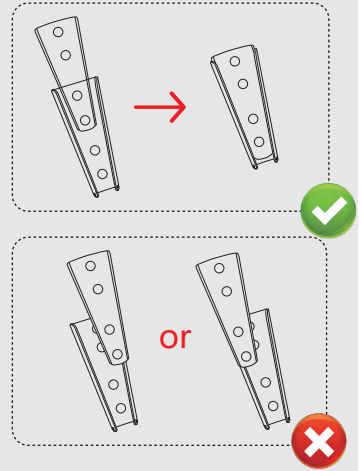
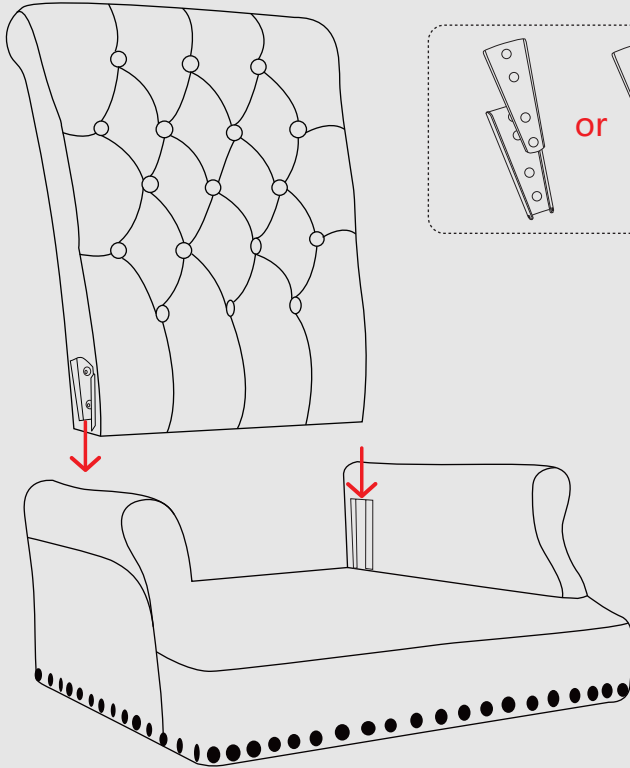

Align the backrest latches with the seat holes and insert them after aligning them correctly.

## Step by Step Guide

2

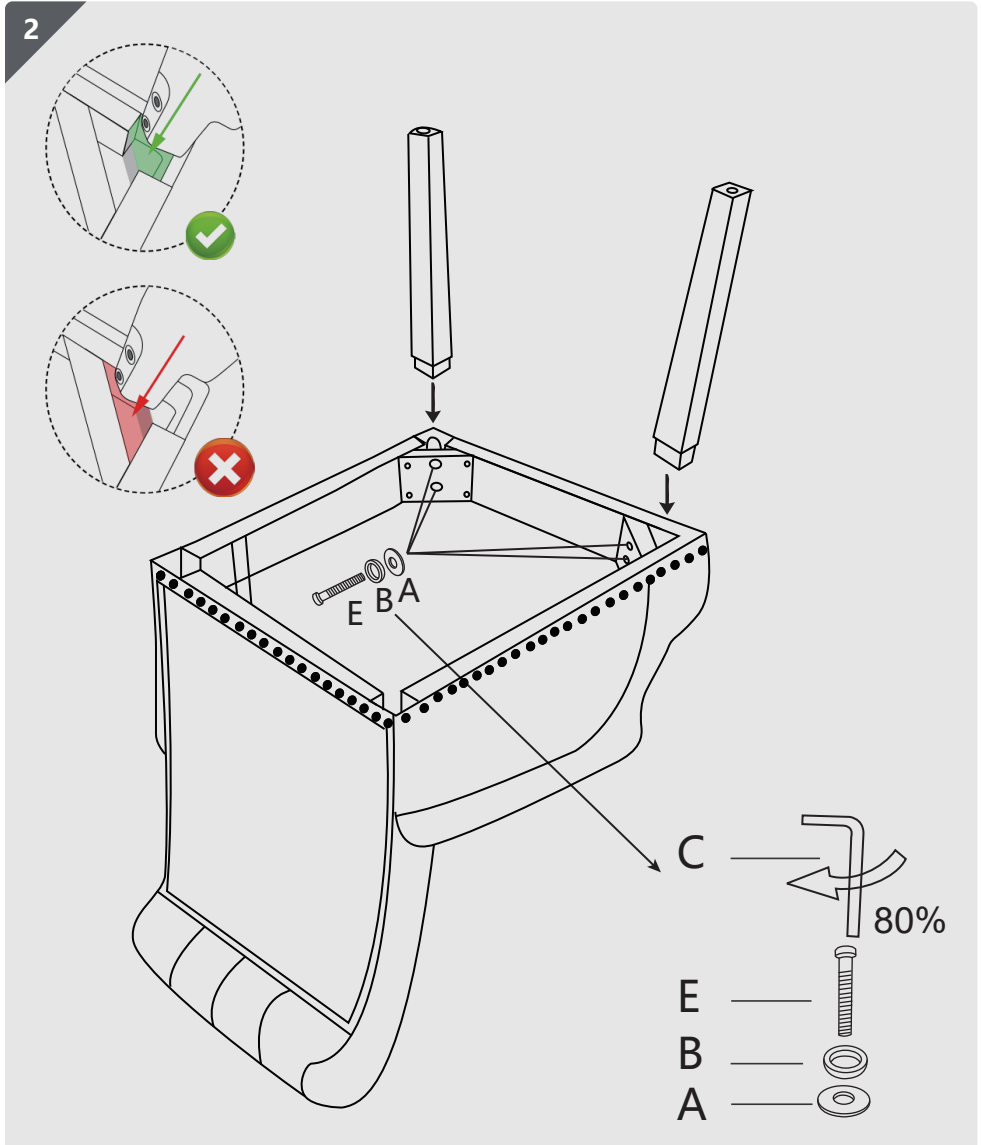

Take the front legs(straight) to align the holes of the seat by screw(E)with washer(A, B).  
Tighten all 4 screws at the same time.  
Just tighten them up to 60%-80%.

## Step by Step Guide

3

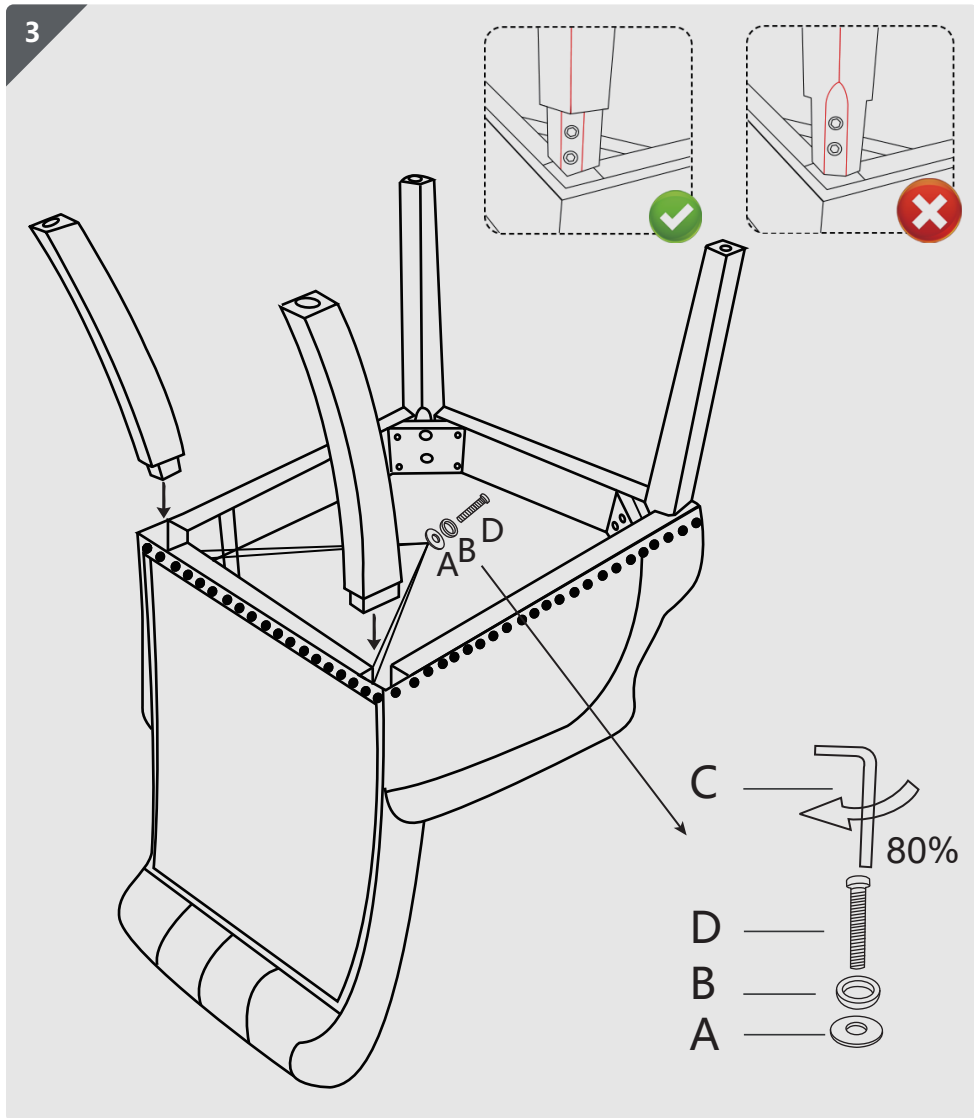

Take the hind legs(curved) to align the holes of the seat by screw(D)with washer(A, B).  
Tighten all 4 screws at the same time.  
Just tighten them up to 60%-80%.

4

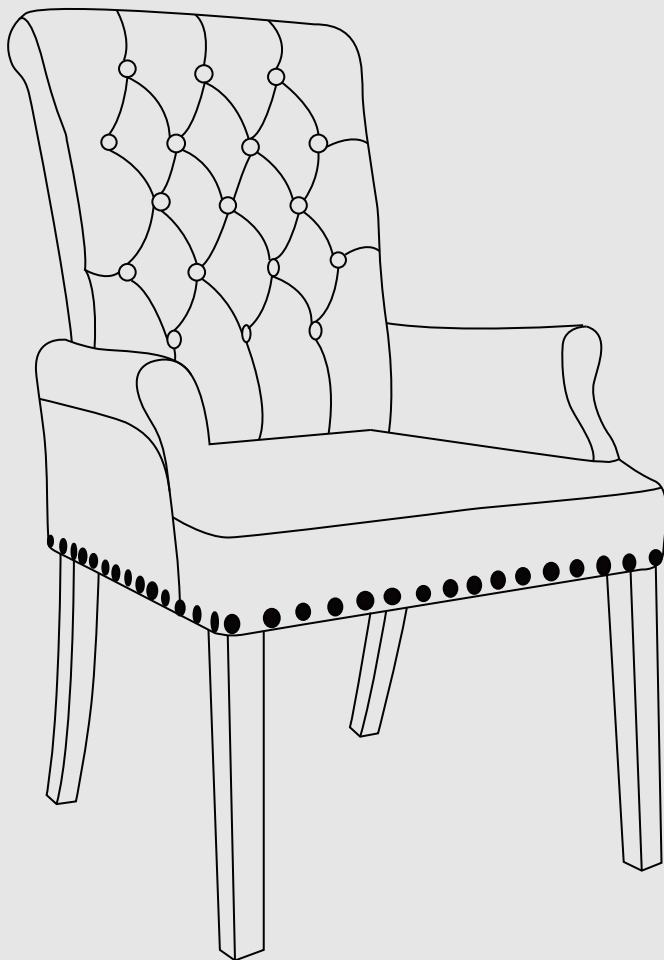

Please put a heavy object or one adult sit on and pressure the chair legs for leveling. Once all legs are leveled, tighten all screws 100%. Put the fabric cover back after finishing the assembly.

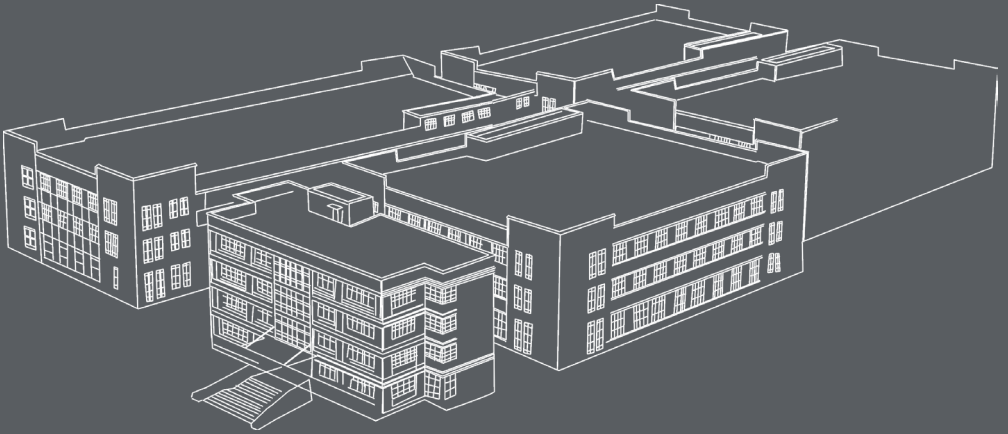

## About us

We are a professional manufactory for making and selling dining chairs. In the past 15 years, we have exported millions of chairs to Europe and USA.

We focus on providing you with high-quality products that meet international standards. To ensure timely shipping, we have built large warehouses in California, New York, and Georgia.

## Contact us

The fastest way to get more information about the deals!

**Email:** [support@pekkohome.com](mailto:support@pekkohome.com)