







ASSEMBLY INSTRUCTIONS & PARTS IDENTIFICATION END TABLE

Thank you for purchasing this quality product. Be sure to check all packing material carefully for small parts that may have come loose inside the carton during shipment.

Parts key			
No	Code	Q'ty	Description
1	a	1 Pc	Storage Box
2	b	4 Pcs	Leg
3	c	1 Set	Pull w/Screw
4	d	1 Set	Drawer Glide
5	e	1 Pc	Shelf
6	f	4 Pcs	Floor Glide
7	g	1 Pc	Drawer Complete
8	h	1 Pc	Drawer stop

Hardware Kit		
No	Description	Q'ty
A	 Bolt Ø7.8 x 60	12 pcs
B	 Lock washer Ø8.5	12 pcs
C	 Flat washer Ø8.5	12 pcs
D	 Allen key	1 pc
E	 Pull	1 pc
F	 Wooden Screws Ø4 x 20mm	2 pcs

STEP 1:

- Carefully lay the Storage box upside down on a smooth flat surface to prevent scratches.
- Attach each Leg assembly to Storage box as shown in illustration.
- Insert a Bolt (A) with Flat washer (C), Lock washer (B) through holes in wood corner of Storage Box. Do not fully tighten.

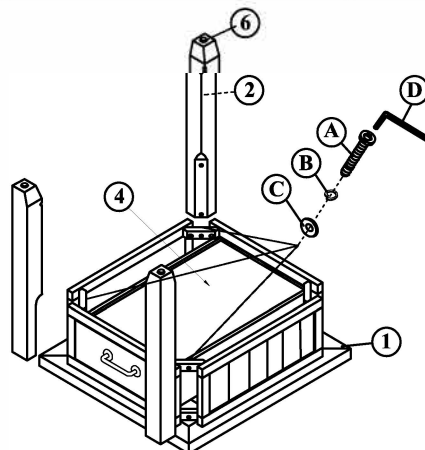

STEP 2:

- Insert the Shelf into designated locations as shown in illustration.
- Insert a Bolt (A) with Flat washer (C), Lock washer (B) through holes in wood corner of Shelf. Fully tighten all bolts with Allen key (D).
- Carefully turn End Table upright.

