

Assembly Instructions

Caution: You must read this before you proceed

Please look in seat for hardware packs and legs.

Chair

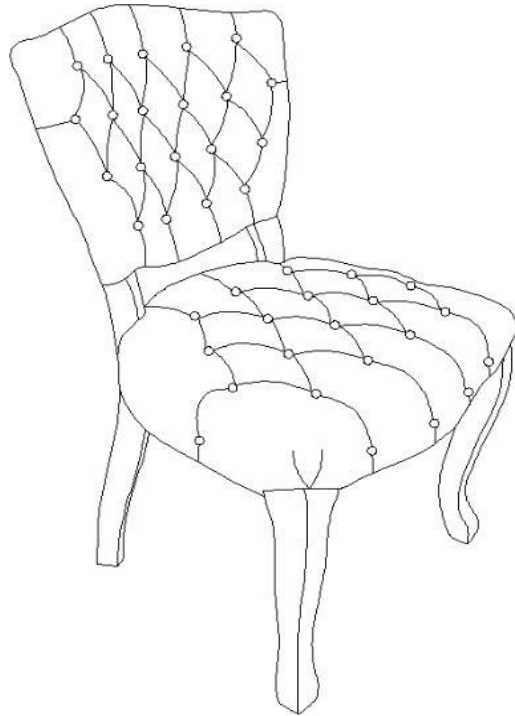

Part List



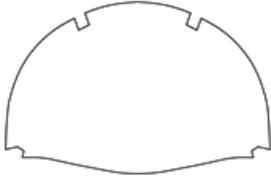

Label	Picture	Description	QTY
A	A line drawing showing the seat and backrest of the chair, which are the main components to be assembled.	Seat with Back	1
B	A line drawing of a single front leg, which is a curved piece of wood or metal.	Front Leg	2

C		Back Leg	2
D		Seat Base Cover	1

Hardware

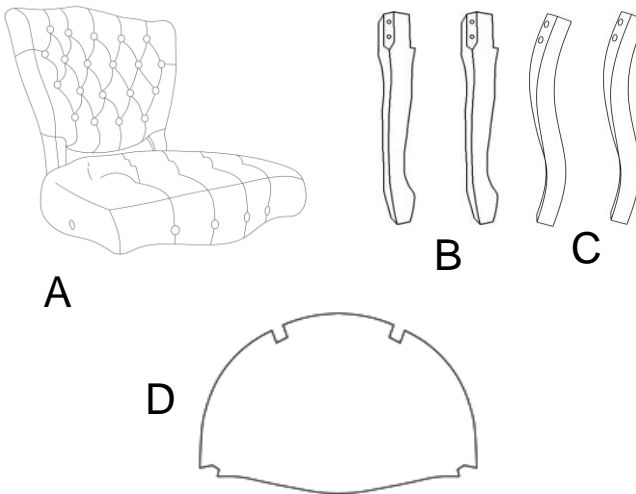
Label	Picture	Description	QTY
①		Bolt (M8*60MM)	9
②		Spring Washer	9
③		Washer	9
④		Allen Key	1

Assembly Preparation

<p>Before Beginning Assembly:</p>		 x 9  x 9  x 9  x 1
-----------------------------------	---	--



- Read instructions, cover to cover-



- Have 2 adults on hand for assembly-



- Do not assemble on flooring or carpet-



- Assemble on a clean non-marring surface (packing foam)-



- Save all packaging until finished-

Assembly Steps

Overview

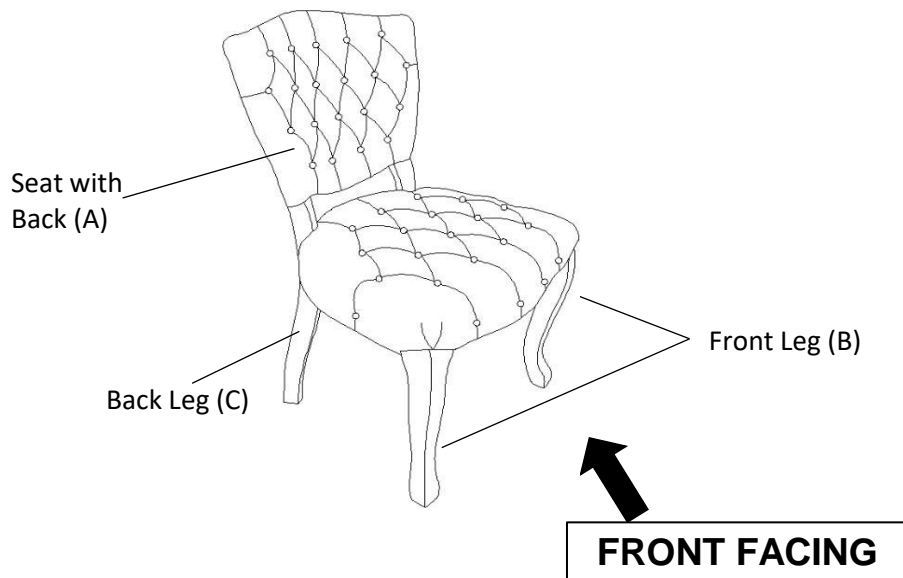

This Chair has multiple parts and may require up to 30 minutes to assemble. To give you an overview of the Chair parts, the above picture is to help you put the various parts into perspective. Please read through the instructions below to familiarise yourself with the parts and steps before assembly.

Step 1

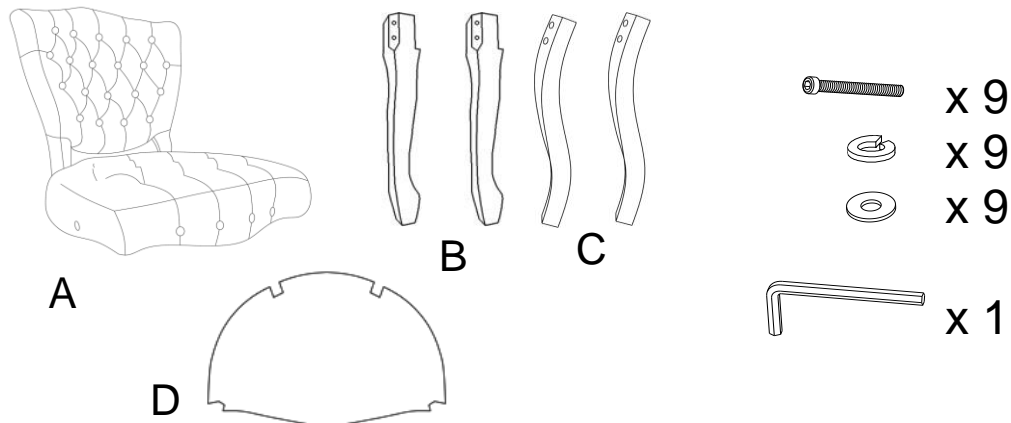

Unpack and place all parts on a clean, non-marring surface.

Step 2

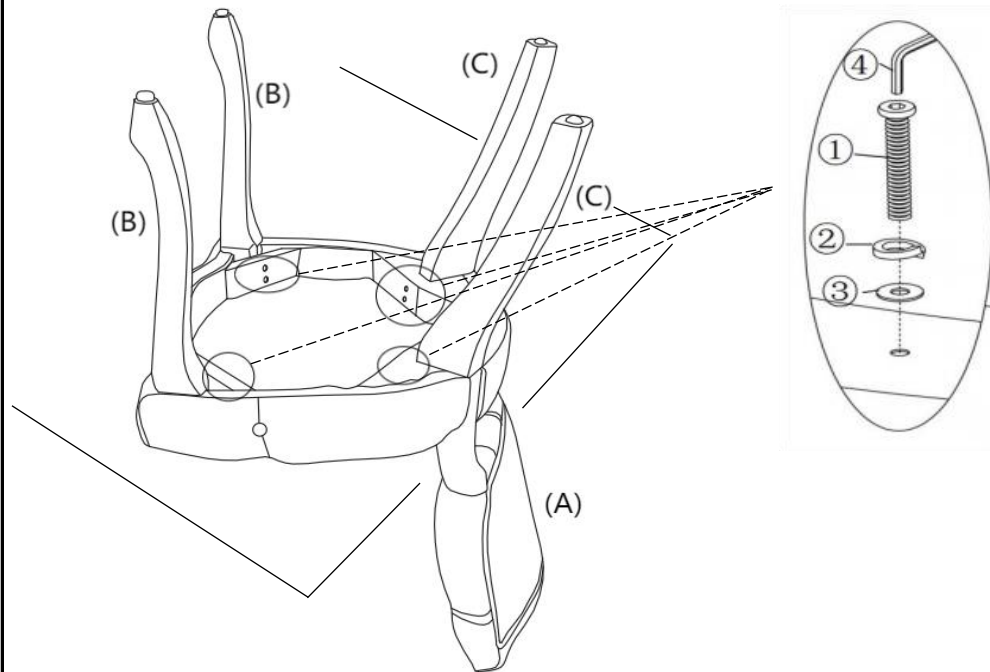

Place the Seat with Back(A) on the side of a table with the Seat facing down, as seen in the picture.

Insert Front Legs(B) and Back Legs(C) into the mounting positions of Seat with Back(A) and attach using Bolts(①), Spring Washers(②) and Washers(③) with the Allen Key(④).

Do not fully tighten the Bolts at this time.

Step 3

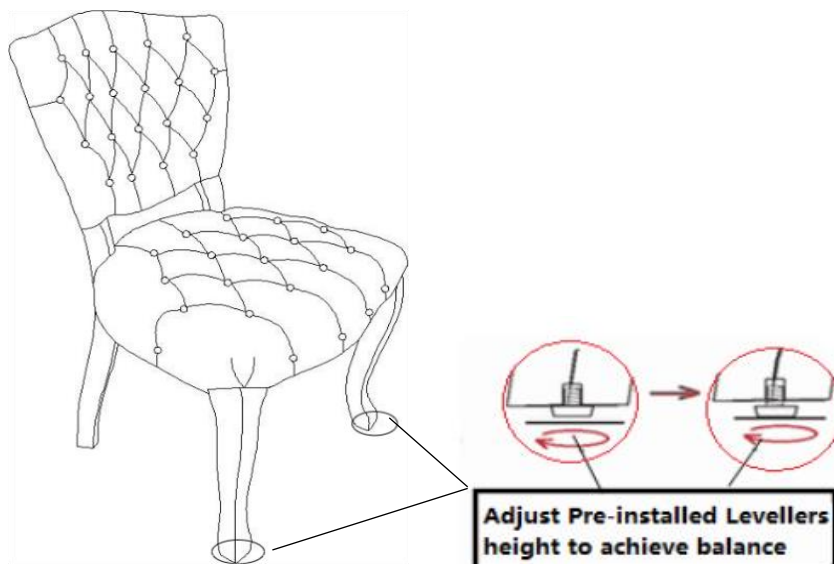

Turn the Chair right side up .

Place the Chair on a level surface to check if it wobbles.

If it is wobbles,adjust the Pre-installed Levellers at the bottom of the Front Legs until the Chair is level.

Tighten all the bolts after the Chair is level.

Step 4

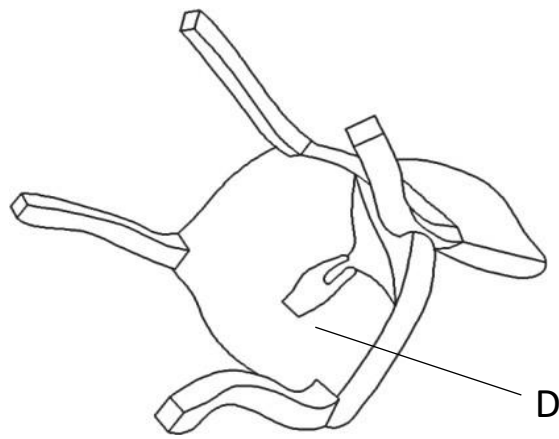

Finally, seal the Seat Base Cover (D) back on to the underside of the seat.

Step 5

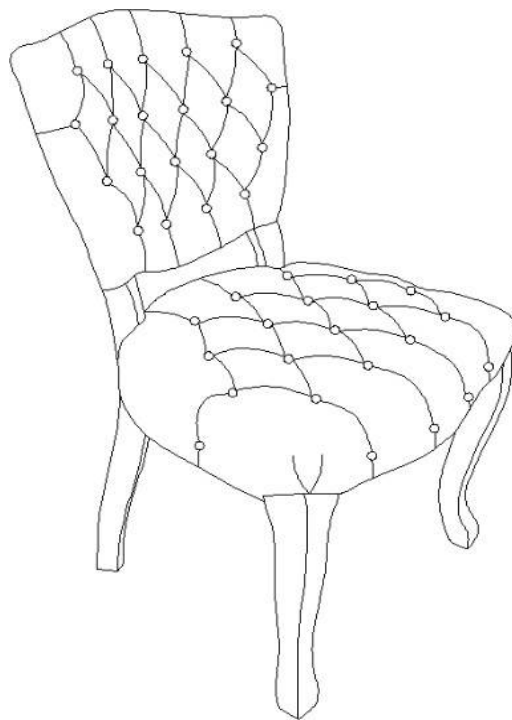











Turn the Chair right side up .

Your Chair is ready for use.

This Chair can only be used on a flat, level surface.

Care & Maintenance

	<ul style="list-style-type: none">● Furniture may scratch floors. We recommend using furniture pads to protect your floors.
	<ul style="list-style-type: none">● Do not put hot items directly on furniture surface.
	<ul style="list-style-type: none">● Do not clean furniture with harsh cleansers or polish.
	<ul style="list-style-type: none">● Do not place furniture under direct sunlight.
	<ul style="list-style-type: none">● Do not place furniture near heating or cooling vents.
	<ul style="list-style-type: none">● Do not write on furniture without a padded barrier to protect the surface.
	<ul style="list-style-type: none">● Do not place furniture outside . For indoor use only.
	<ul style="list-style-type: none">● Not for commercial use. For residential use only.
	<ul style="list-style-type: none">● Stains may be removed with mild soap solution and damp cloth.
	<ul style="list-style-type: none">● Children should not climb or jump on the furniture.
	<ul style="list-style-type: none">● Dust and pick-up spills using a clean, non-colored, lint-free cloth.