

10 : 00

estimated
installation time



1 or more

people required

Ok, let's
get started!



- Put on mood music!
- To prevent damage to product, use the clean side of package carton or rug as working surface.
- In the event of missing or damaged parts, delivery problems etc., please reach out to our team.
We will be happy to fix the problem!

care guide

- Clean regularly with a soft and dry cloth.
- To protect finish, avoid use of abrasive cleaners.
- Wipe up spills immediately. Please!



product
parts

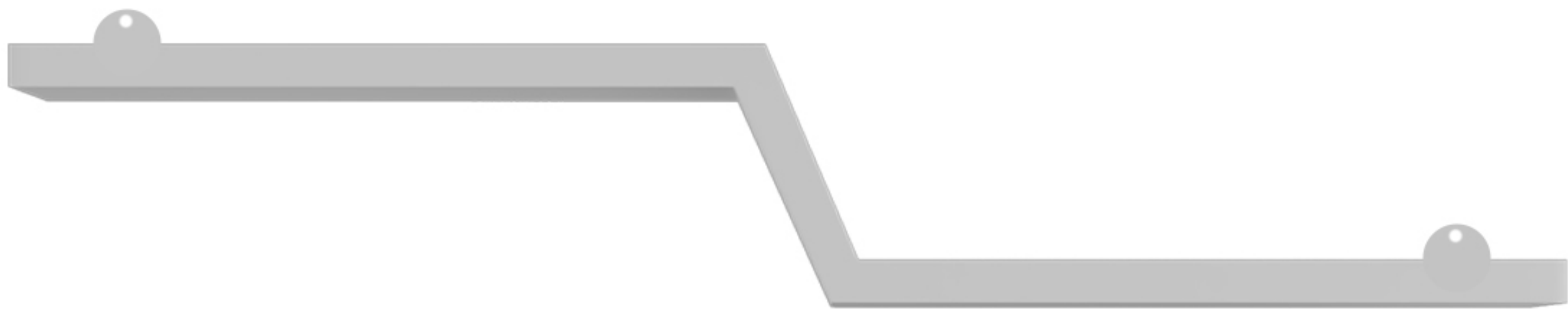

(A)
Shelf
x1



(B)
Shelf
x1

what's included

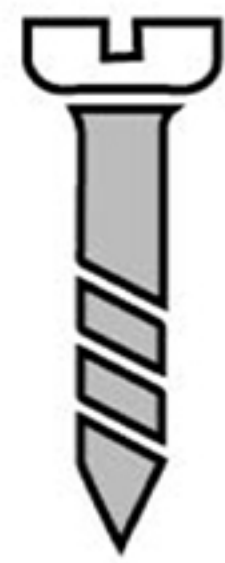

(C)- Screw
x4



(D)- Wall Plug
x4

installation instructions

Take a deep breath going in.
This is easy even if you are not
used to tools. Just follow these
steps to the T, and the
outcome will be
worth it!



step 1:

Begin by placing shelf (A) on the wall and put a spirit level on it to check the alignment. Adjust if needed.

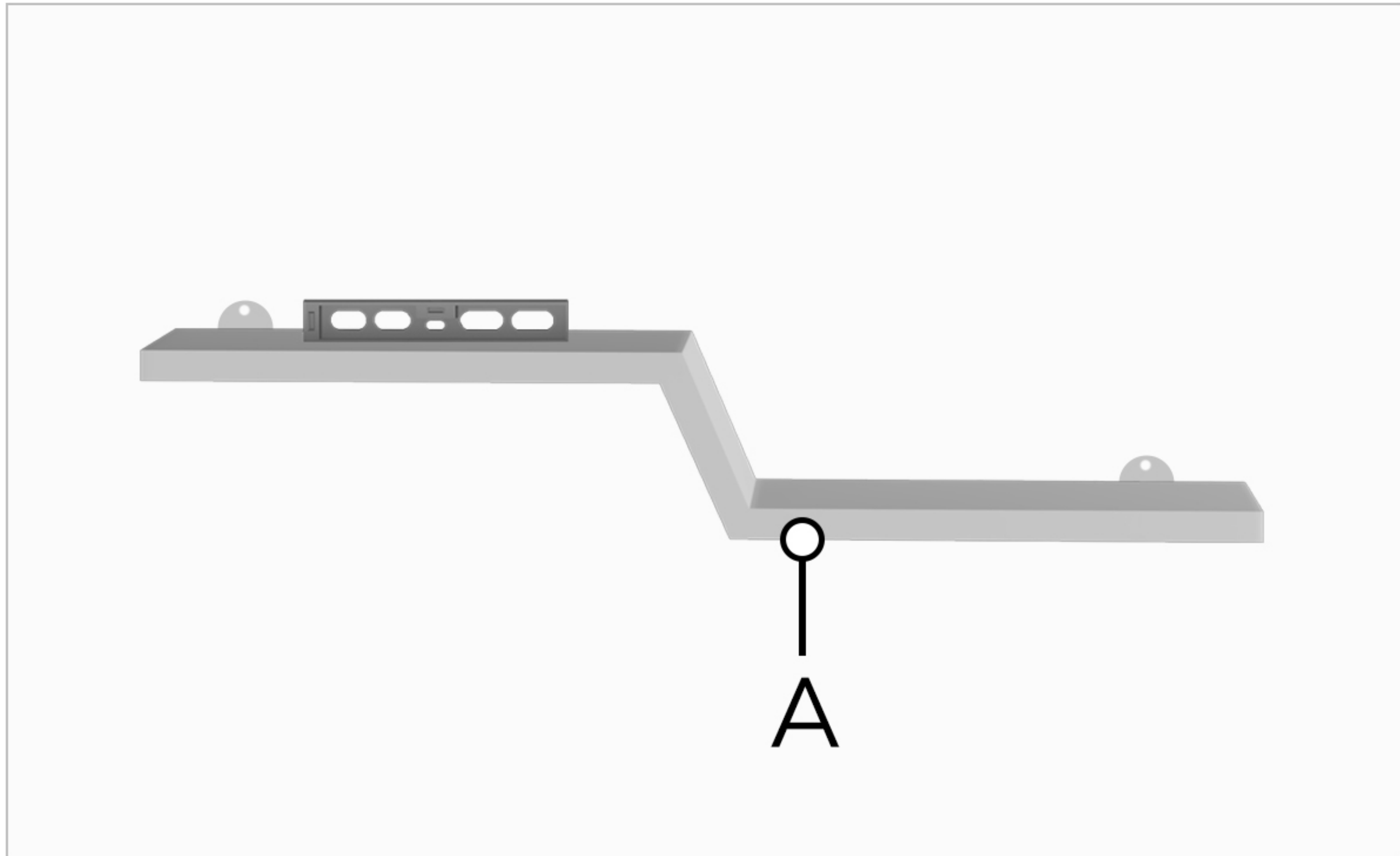

step 2:

Once the shelf is in a straight alignment, use a pencil to mark two points through the holes given in the D-bracket. Take this image as a reference.

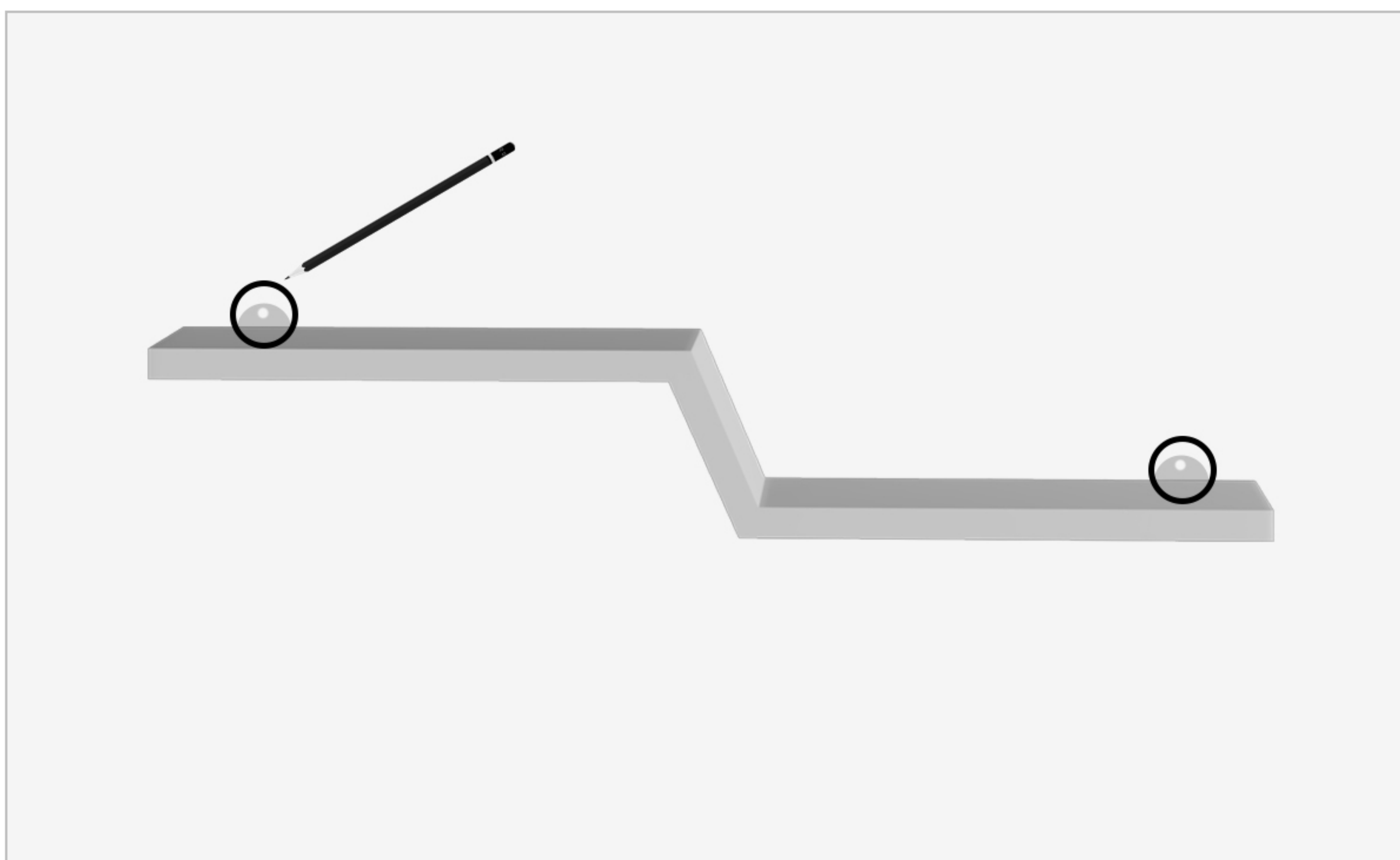

step 3:

Drill holes approx. 10 mm at the points you just marked



step 4:

Insert the wall plug (D) and tighten with the help of a screwdriver.

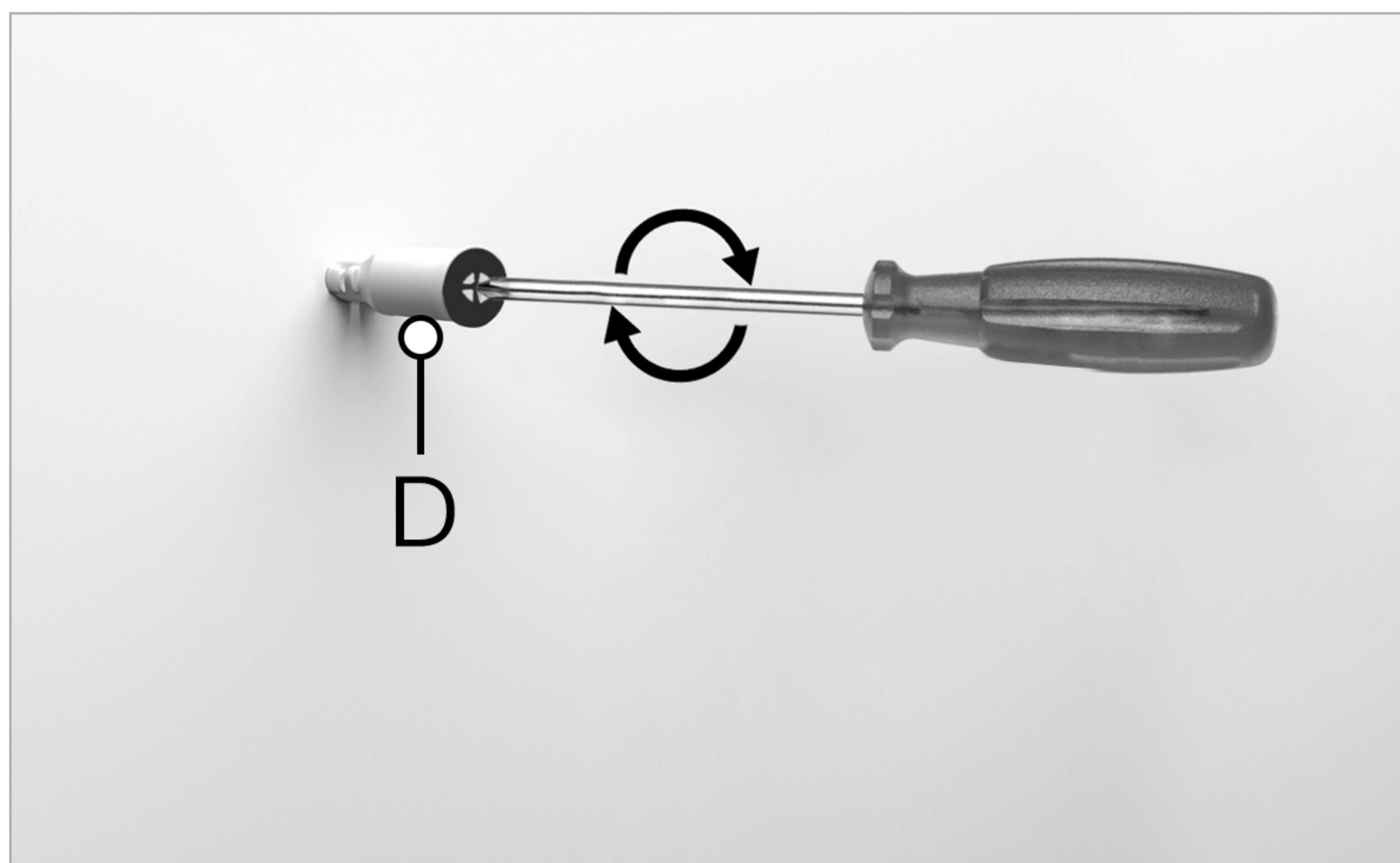

step 5:

place the shelf over the wall plugs and insert screws (C) into the wall plugs using a screwdriver.

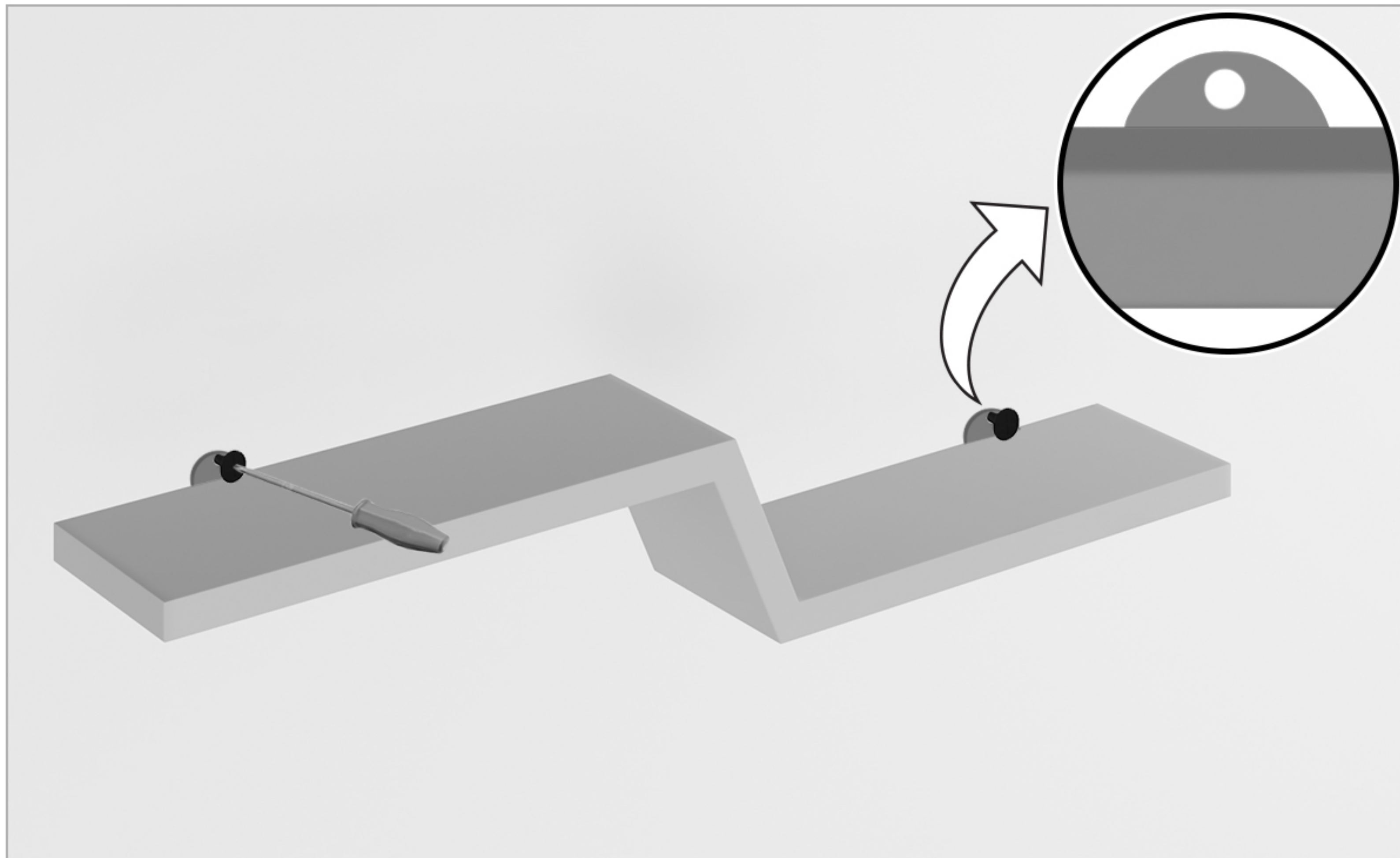

step 6:

Follow the same steps to install shelf (B). Place it on the wall where you want it and put a spirit level on it to check the alignment. Adjust if needed.

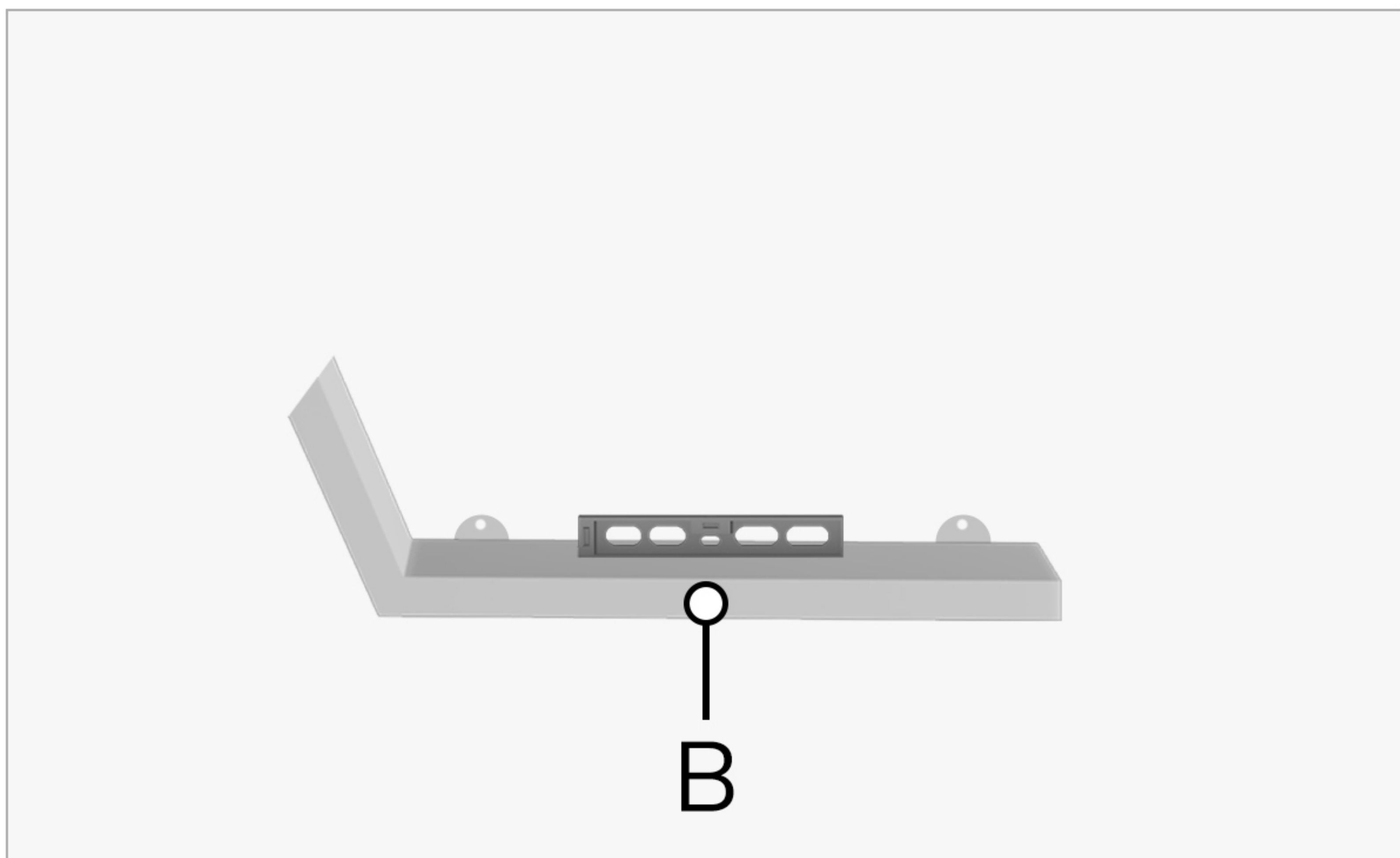

step 7:

Using the holes on D-brackets, mark the drilling points.

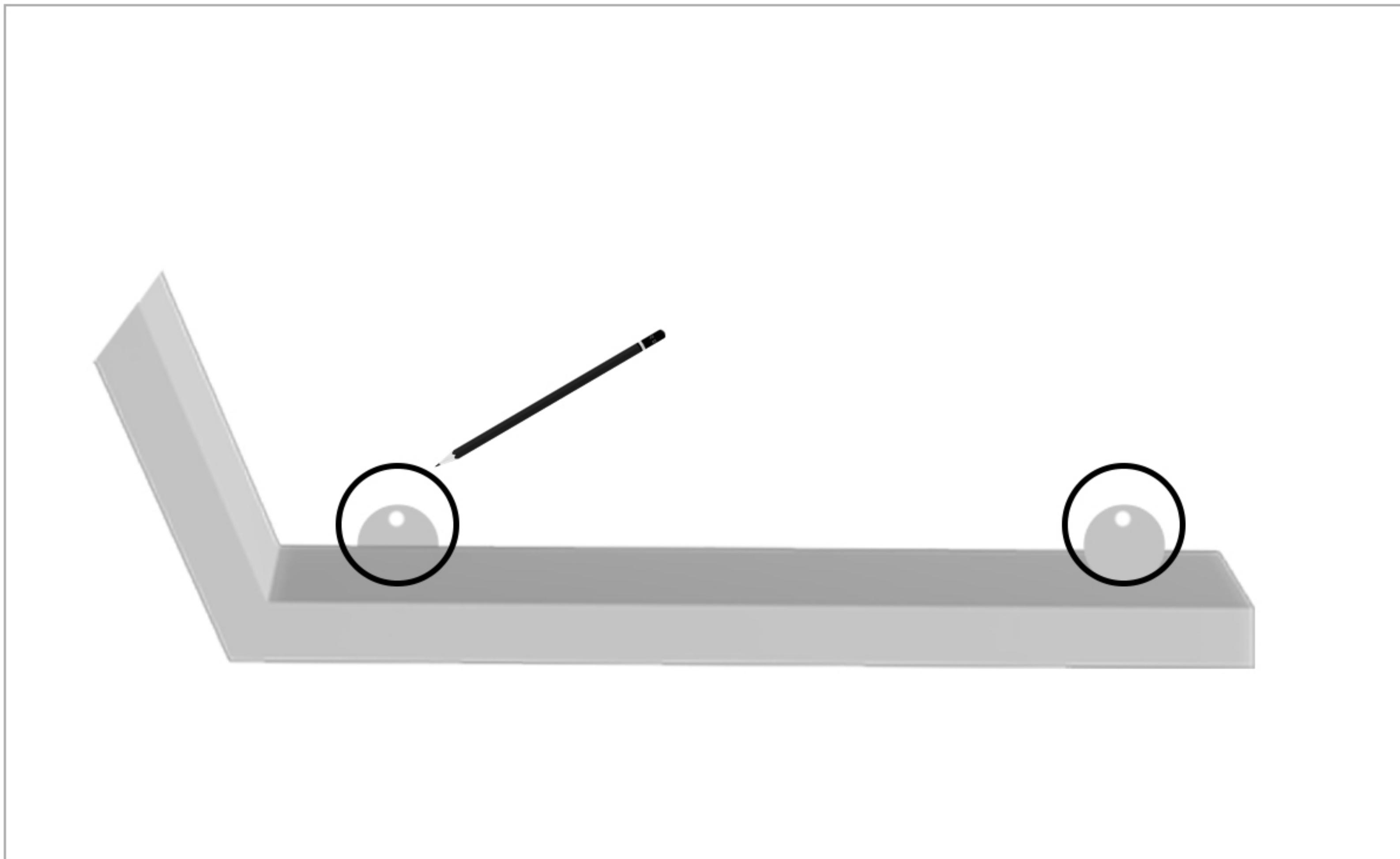

step 8:

Drill holes approx. 10 mm at the points you just marked



step 9:

Insert the wall plug (D) and tighten with the help of a screwdriver.

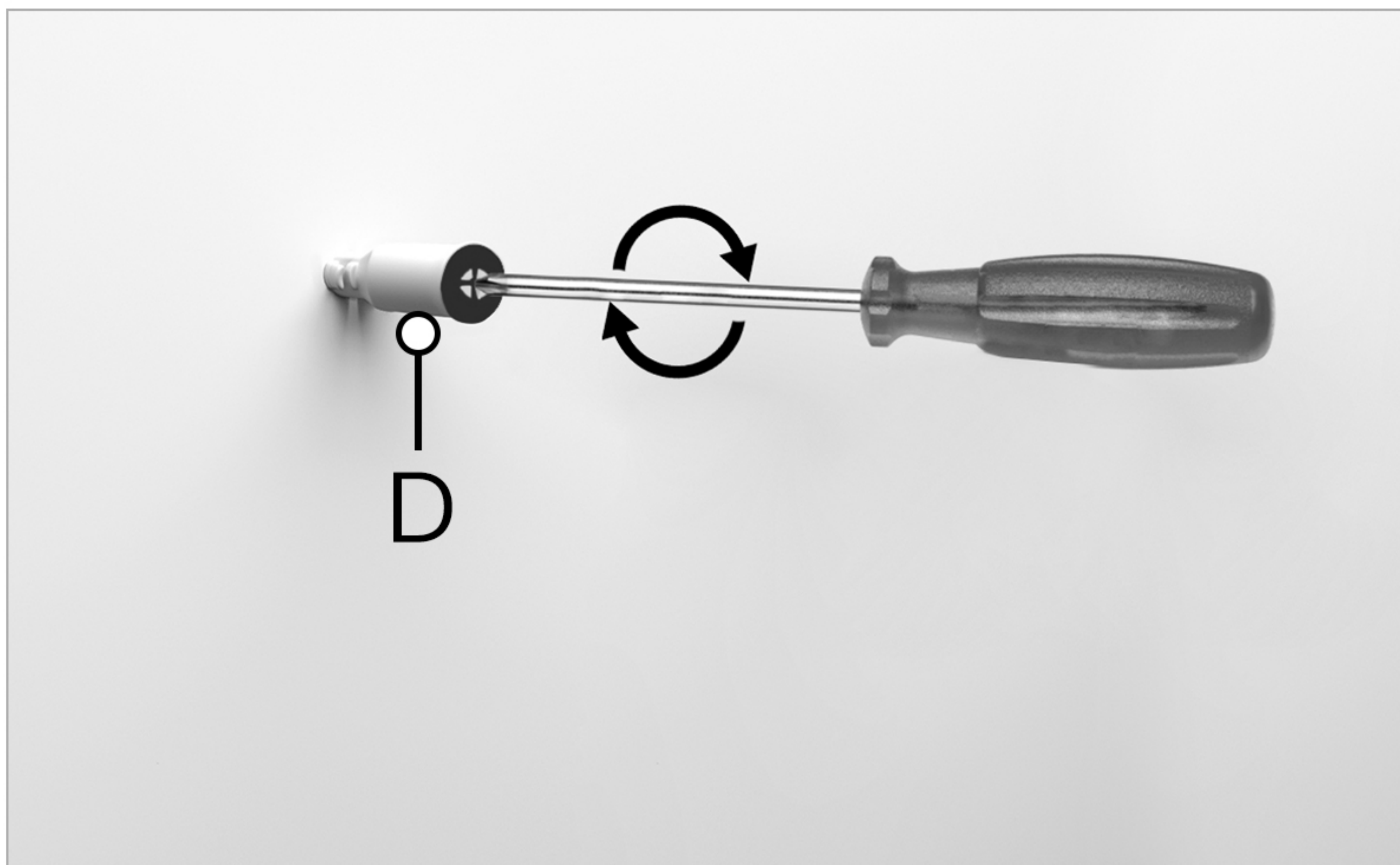

step 10:

place the shelf over the wall plugs and insert screws (C) into the wall plugs using a screwdriver.

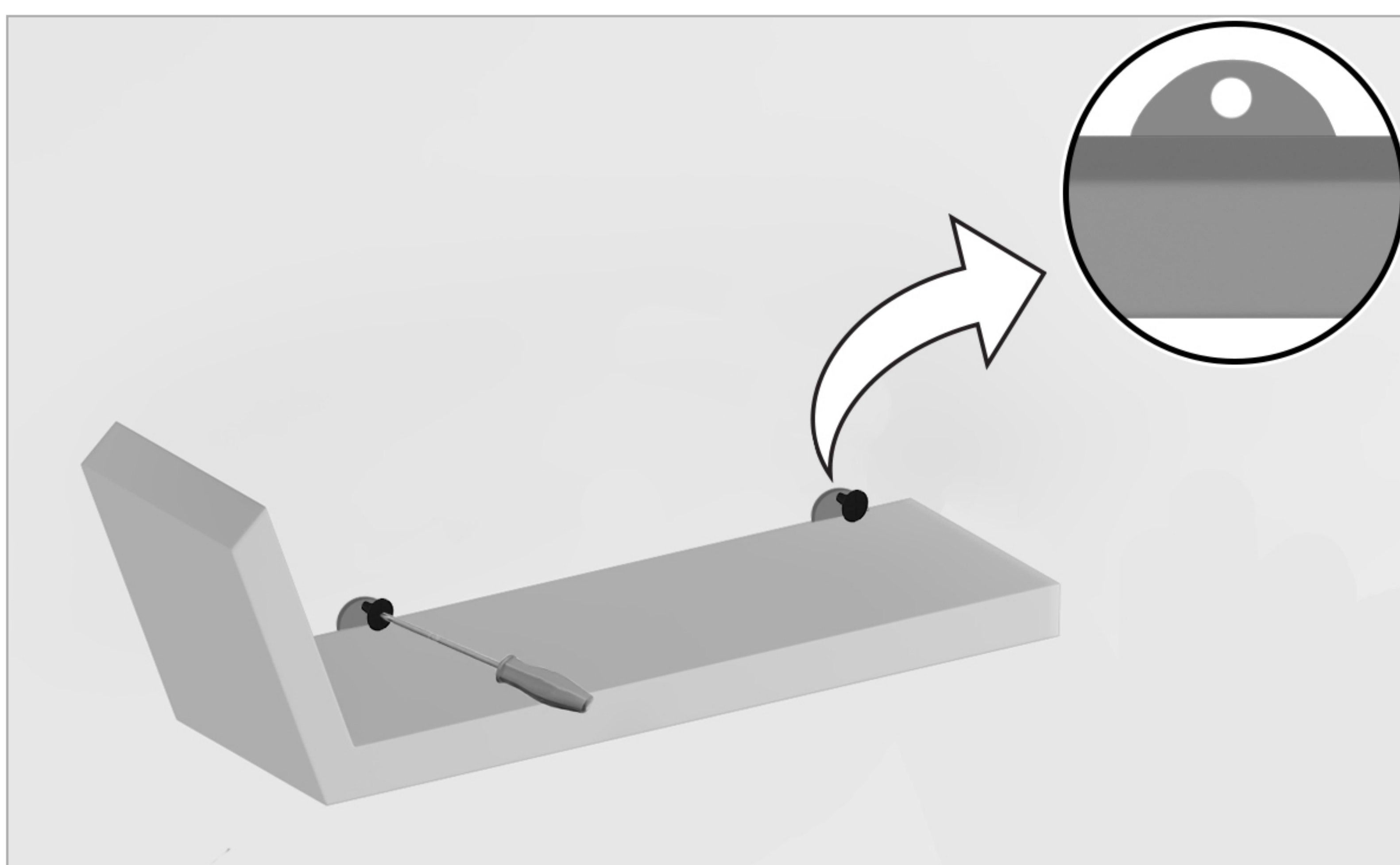

Voila! Your shelf is now installed and secure!